

# MX753

FINESTRE A BATTENTE A TAGLIO TERMICO  
*CASEMENT WINDOWS W/THERMAL BREAK*



**TWIN**  
**SYSTEMS**

ARCHITETTURE IN ALLUMINIO

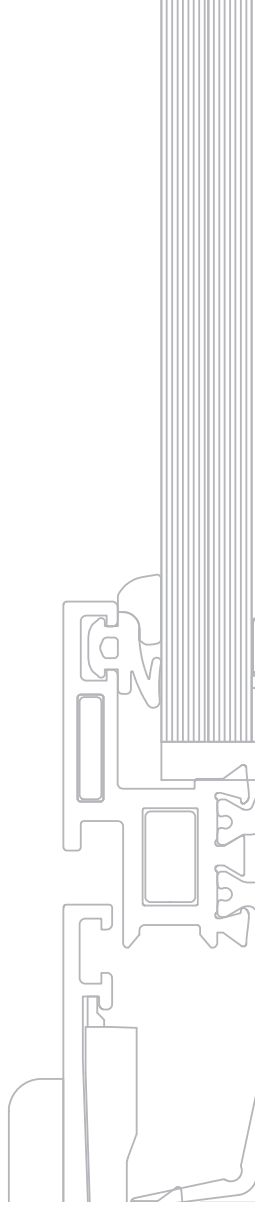

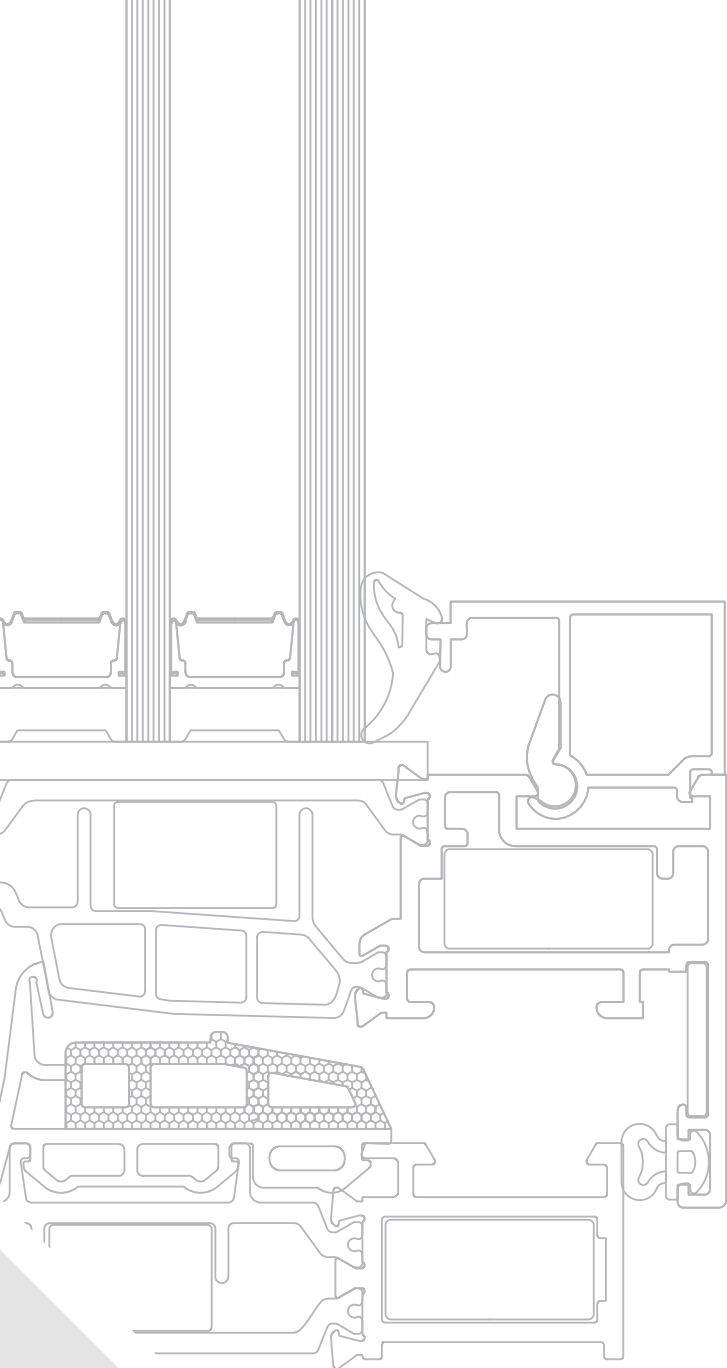

# MX753

FINESTRE A BATTENTE A TAGLIO TERMICO  
*CASEMENT WINDOWS W/THERMAL BREAK*







# TWIN SYSTEMS

ARCHITETTURE IN ALLUMINIO

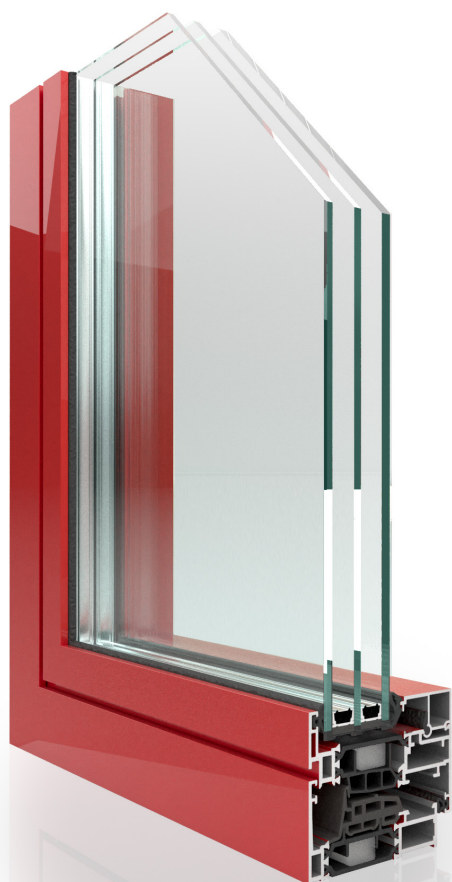

## **Gruppo A** Informazioni Generali *Informazioni Generali*

Indice Generale  
Caratteristiche Alluminio  
Descrizione Tecnica sistema  
Descrizione Tecnica Capitolato  
Collaudi Prestazionali

*Table of Contents  
Aluminium Characteristics  
Technical Description  
Technical Specifications  
Performance Tests*

## **Gruppo B** Profili *Profiles*

Elenco Profili  
Profili Scala 1:1

*Profiles List  
Profiles Scale 1:1*

## **Gruppo C** Accessori e Guarnizioni *Accessories and Gaskets*

Elenco accessori  
Elenco guarnizioni

*List of Accessories  
List of Window Gaskets*

## **Gruppo D** Nodi *Main Sections*

Sezioni principali  
e Accessori  
Sc. 1:1

*Main Sections and  
Accessories  
Scale 1:1*

## **Gruppo E** Tipologie *Types*

Tipologie

*Types*

## **Gruppo F** Attacco alla Muratura *Wall Joint*

Sezione particolareggiata  
attacco alla muratura

*Wall Joint Detail*

## **Gruppo G** Lavorazioni/Montaggi *Tooling/Assembly*

Schemi Lavorazioni  
Frese  
Attrezzatura

*Tooling Systems  
Cutters Equipments  
Milling*

Tutti i dati riportati sul presente catalogo sono indicativi e non impegnativi. La società si riserva il diritto di apportare in qualsiasi momento modifiche atte a migliorare i prodotti. Per informazioni tecniche riguardanti il catalogo contattare l'ufficio tecnico.

*All the data shown in this catalog are indicative and not binding. The company reserves the right to make changes to improve the products at any time. For technical information regarding the catalog, contact the technical department.*





**Informazioni Generali**  
*General Information*

**Gruppo A**

|                                |                                  |
|--------------------------------|----------------------------------|
| Indice Generale                | <i>Table of Contents</i>         |
| Caratteristiche Alluminio      | <i>Aluminium Characteristics</i> |
| Descrizione Tecnica sistema    | <i>Technical Description</i>     |
| Descrizione Tecnica Capitolato | <i>Technical Specifications</i>  |
| Collaudi Prestazionali         | <i>Performance Tests</i>         |





**PESO PROFILATI**

Il peso indicato è quello teorico e potrà variare in funzione delle tolleranze di spessore e dimensionali dei profilati (NORMA UNI EN 12020-2)

**LEGA DI ESTRUSIONE**

I profilati sono estrusi in lega EN-AW-6060 (UNI EN 573/3)

**DIMENSIONI DEI PROFILATI**

Le dimensioni indicate sono quelle teoriche, potranno quindi variare in funzione delle tolleranze dimensionali di estrusione (norma UNI EN 12020-2). Questa variabilità che interessa tutti i profilati, può influire, anche se minimamente, sulle dimensioni di taglio e quindi finali del serramento. Anche la verniciatura, aumentando gli spessori, contribuisce a far variare la dimensione dei profilati e, particolarmente, riduce lo spazio nelle sedi di inserimento delle guarnizioni e degli accessori.

**DIMENSIONI DI TAGLIO E LAVORAZIONI**

Le dimensioni teoriche di taglio e le quote delle lavorazioni indicate nel presente catalogo sono esatte, ovvero matematicamente corrette, in certi casi dovranno, nella pratica, essere adattate in base alla precisione ed al tipo di impostazione delle misure delle macchine utilizzate. È pertanto consigliabile nei primi lavori o nel caso di importanti quantità di serramenti effettuare delle campionature di prova.

**PROTEZIONE SUPERFICIALE**

Al fine di limitare i processi di corrosione filiforme è importante applicare le seguenti regole:

- ◆ **Utilizzare accessori di assemblaggio in alluminio**
- ◆ **Utilizzare viti in acciaio inox**
- ◆ **Proteggere le parti tagliate e lavorate con prodotti idonei**
- ◆ **Evitare ristagni di condense all'interno dei profilati.**

Per la realizzazione di serramenti è necessario attenersi alla tecnologia costruttiva e utilizzare le guarnizioni e gli accessori originali riportati sul catalogo tecnico e al rispetto delle norme, prescrizioni e raccomandazioni vigenti. L'osservanza di quanto sopra determina la garanzia. Su queste basi sono stati realizzati campioni che, collaudati in laboratorio hanno ottenuto i risultati indicati nelle certificazioni. Per il buon funzionamento e la durata degli infissi realizzati con profilati ed accessori del sistema, è necessario effettuare alcune semplici operazioni:  
una buona pulizia, eliminando residui di calce, cemento e/o altro. È consigliabile peraltro proteggere il manufatto sino al momento della messa in esercizio, lubrificare con olio o grasso neutri le parti in movimento e gli organi di chiusura, controllare il corretto serraggio delle viti e dei grani, controllare gli assetti, registrandoli laddove sono previste regolazioni. Si raccomanda di effettuare queste operazioni almeno con cadenza semestrale. In caso di funzionamento anomalo di qualche componente, evitare assolutamente interventi atti a modificarne le caratteristiche e la sostituzione con ricambi non originali. Ci sembra utile ricordare che interventi di regolazione e/o sostituzione, con particolare riferimento ai meccanismi per oscillo-battente, andranno eseguiti da personale specializzato. Si raccomanda inoltre, in occasione delle operazioni di pulizia, di non utilizzare detergenti che possano deteriorare i trattamenti superficiali, escludendo tassativamente acidi, solventi, materiali abrasivi, spazzole metalliche o comunque in grado di scalfire le superfici, pagliette metalliche e altro.

**WEIGHT OF PROFILES**

The weight indicated is the theoretical one and may vary depending on the thickness and dimensional tolerances of the profiles (STANDARD UNI EN 12020-2)

**EXTRUSION ALLOY**

The profiles are made of extrusion alloy EN-AW-6060 (UNI EN 573/3)

**DIMENSIONS OF PROFILES**

The dimensions indicated are the theoretical ones; they may vary depending on the extrusion dimensional tolerances (STANDARD UNI EN 12020-2). This variability, which affects all the profiles, can affect, even if minimally, the cutting size and, therefore, the final size of the window. Also the coating, increasing the thickness, affects the size of the profiles and, in particular, reduces the space in the housing of window gaskets and accessories.

**CUTTING AND TOOLING DIMENSIONS**

The theoretical cutting and tooling sizes indicated in this catalogue are accurate, that is, they are mathematically correct. In practice, in some cases they may need to be adapted to take into consideration the precision and dimensional settings of the machines used. We therefore recommend that test samples be made in the first jobs or in the case of large quantities of windows.

**SURFACE PROTECTION**

The rules below should be followed to limit filiform corrosion phenomena:

- ◆ **Use aluminium assembly accessories**
- ◆ **Use stainless steel screws**
- ◆ **Use appropriate products to protect cut and tooled parts.**
- ◆ **Prevent condensation from accumulating inside the profiles.**

When making the windows, comply with the construction technology, use original window gaskets and accessories as listed in the technical catalogue and comply with applicable standards, provisions and recommendations. Non-compliance with the above rules invalidates the warranty. Samples have been made on these bases that, tested in the laboratory, have obtained the results indicated in the certifications. Some simple actions are necessary for the proper functioning and durability of window frames made with the system's profiles and accessories: good cleaning, eliminating traces of lime, cement, etc.

The product should be protected until the time of installation, lubricate moving parts and closing devices with neutral oil or grease, check that the screws and grub screws are tightened, check the trims, adjusting them where necessary. These operations should be carried out at least once every six months. Should any component not function correctly, do nothing to modify its characteristics and do not use non-original spare parts. Remember that adjustments and/or replacements, with special reference to tilt&turn mechanisms, must be carried out by specialized personnel. During cleaning operations, detergents that can damage surface treatments - e.g. acids, solvents, abrasive materials, metal brushes or in any case able to scratch the surfaces, steel wool, etc. - should not be used.

**DIMENSIONI E TIPOLOGIA DEI SERRAMENTI**

La valutazione delle dimensioni dei serramenti, richiede la considerazione di vari fattori quali: il momento d'inerzia dei profilati, le dimensioni e il peso dei tamponamenti (vetri-pannelli), la larghezza e l'altezza delle parti apribili, caratteristiche e portate degli accessori, le condizioni e le quantità degli ancoraggi alle opere morte, l'esposizione, ecc... Fattori che sono valutabili e applicabili, grazie alla buona conoscenza dello stato dell'arte, alle informazioni riportate dai cataloghi, manuali tecnici e dalle normative vigenti. Consigliamo, al fine di evitare inutili contestazioni, di consultare il nostro servizio tecnico sistemi, prima di realizzare serramenti che, per dimensione, forma, esposizione e/o altro possono essere ritenuti atipici. Le soluzioni e le combinazioni proposte in questo catalogo, non hanno carattere limitativo, ma presentano solo le situazioni e combinazioni più comunemente riscontrabili nella realtà.

**DIMENSIONS AND TYPE OF WINDOWS**

*Various factors must be taken into consideration when assessing the dimensions of the windows, such as: the moment of inertia of the profiles, the dimensions and weight of the panels (glass-panels), the width and height of the opening parts, the characteristics of the accessories, the condition and number of fastenings to the dead work, the exposure, etc. These factors can be assessed and applied, thanks to the good knowledge of the state of the art and to the information reported in catalogues, technical manuals and current regulations.*

*In order to avoid needless complaints, we invite you to contact our technical service before making windows that, due to their size, shape, exposure and/or other characteristic, could be considered non-standard. The solutions and combinations proposed in this catalogue are not the only ones available, but merely represent the most common situations and combinations.*

**COMPOSIZIONE PROFILATI**

I profilati per serramenti saranno in lega di alluminio ENAW 6060 (EN 573-3 e EN 755-2) con stato fisico di fornitura UNI EN 515. I telai fissi e le ante mobili dovranno essere realizzati con profilati ad interruzione di ponte termico a tre camere (profilo interno ed esterno tubolari, collegati tra di loro con barrette in poliammide PA6.6 rinforzate con fibra di vetro).

**INFISSI**

Le finestre e le porte finestre dovranno avere un profilato di telaio fisso con profondità minima 75.3 mm. ed un profilato di anta mobile con profondità minima 84.8 mm. I profilati di telaio fisso dovranno prevedere, dove necessario, alette incorporate di battuta interna sulla muratura da 25 mm.

I profilati di ante mobili dovranno avere un' aletta esterna di battuta per vetro con altezza di 16 mm ed una aletta di battuta interna sul telaio fisso con sormonto di 6 mm. La barretta in poliammide del profilato anta a contatto con la guarnizione di tenuta centrale (giunto aperto), dovrà essere di forma tubolare.

**ISOLAMENTO TERMICO**

L'interruzione del ponte termico sarà ottenuta da barrette continue in poliammide da 43-39 mm. totale e dovrà garantire un valore di trasmittanza termica per l'infisso  $U_w = \dots\dots\dots W/m^2K$ . L'assemblaggio dei profilati in alluminio a taglio termico dovrà garantire i valori di scorrimento (T) tra profilati in alluminio e barrette in POLIAMMIDE previsti dalla direttiva tecnica Europea (UEAtc).

**DRENAGGI E VENTILAZIONE**

I profilati esterni delle ante mobili dovranno prevedere una gola ribassata per la raccolta delle acque di infiltrazione e di condensa onde poter permettere il libero deflusso delle stesse attraverso apposite asole di scarico. Le barrette in poliammide dovranno avere una conformazione geometrica atta ad evitare eventuale ristagno di acque di infiltrazione e di condensa ed essere perfettamente complanari con le pareti trasversali dei profilati di alluminio.

**ACCESSORI DI ASSEMBLAGGIO**

Le giunzioni tra profilati orizzontali e verticali dovranno essere perfettamente solidali e ben allineate tra di loro, sia nella parte esterna che interna dei profilati ed unite mediante apposite squadrette a bottone o, in alternativa, in alluminio estruso o pressofuso, con metodo a spino-cianfrinatura od a cianfrinatura totale. Le sezioni dei profilati orizzontali e verticali dovranno essere opportunamente sigillate prima di essere unite con le squadrette. I fermavetri saranno accoppiati a scatto e posizionati nei canali dei profilati in alluminio.

**GUARNIZIONI**

Tutte le guarnizioni: cingivetro, di tenuta, di battuta.... dovranno essere in elastomero (EPDM). In particolare la guarnizione di tenuta centrale (giunto aperto) dovrà assicurare la continuità perimetrale mediante l'impiego di angoli vulcanizzati preformati incollati alla stessa o in alternativa mediante telai vulcanizzati.

**PRESTAZIONI**

I serramenti dovranno avere prestazioni di permeabilità all'aria, tenuta all'acqua e resistenza ai carichi del vento conformemente alle norme: (UNI-EN 12207 - 12208 - 12210 e UNI-EN 1026 - 1027 - 12211)

**PROFILE COMPOSITION**

The window profiles are made of ENAW 6060 aluminum alloy (EN 573-3 and EN 755-2) with physical state of supply UNI EN 515. The fixed frames and sliding doors must be made with three-chamber thermal break profiles (tubular internal and external profile, connected to each other with glass fibre reinforced polyamide PA6.6 bars).

**DOORS AND WINDOWS**

The windows and French doors must have a fixed frame profile with a minimum depth of 75.3 mm and a sliding door profile with a minimum depth of 84.8 mm. Where necessary, the fixed frame profiles must have an incorporated 25 mm internal stop flap on the brickwork.

The profiles of sliding doors must have an external stop flap for glass with a height of 16 mm and an internal stop flap on the fixed frame with overlap of 6 mm. The polyamide bar of the door profile in contact with the central sealing gasket (open joint), must be tubular.

**THERMAL BREAK**

The thermal bridge will be interrupted using solid 43-39 mm. polyamide bars guarantee a heat transmission value of the frame  $U_w = \dots\dots\dots W/m^2K$ . The assembly of aluminum profiles with thermal break will guarantee the slide values (T) between the aluminium profiles and polyamide bars set forth in the European Technical Directive (UEAtc).

**DRAINAGE AND VENTILATION**

The junctions between horizontal and vertical profiles must be perfectly integral and well aligned with each other, both in the external and internal part of the profiles and joined by means of special button brackets or, alternatively, in extruded or die-cast aluminum, with the pin-crimping method or with total crimping. The sections of the horizontal and vertical profiles must be properly sealed before being joined with the brackets. The glazing beads will be snap coupled and positioned in the channels of the aluminum profiles.

**ASSEMBLY ACCESSORIES**

The joints between the horizontal and vertical profiles must be perfectly united and correctly aligned with each other, both externally and internally and joined by means of special slot corner joints or, alternatively, in extruded or die-cast aluminum, with a dowel-crimping or full crimping method. The sections of the horizontal and vertical profiles must be properly sealed before being joined with the corner joints. The glazing beads will be snap-coupled and positioned in the channels of the aluminum profiles.

**WINDOW GASKETS**

All window gaskets: glazing, sealing, rabbet.... must be made of elastomer (EPDM). Specifically, the central sealing gasket (open joint) must ensure perimeter continuity using preformed vulcanized corner joints glued to it or, alternatively, vulcanized frames.

**PRESTAZIONI**

I serramenti dovranno avere prestazioni di permeabilità all'aria, tenuta all'acqua e resistenza ai carichi del vento conformemente alle norme: (UNI-EN 12207 - 12208 - 12210 e UNI-EN 1026 - 1027 - 12211)

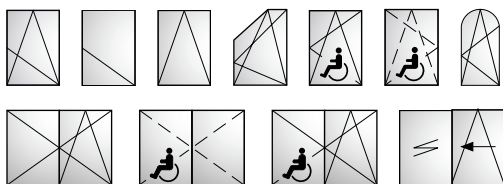
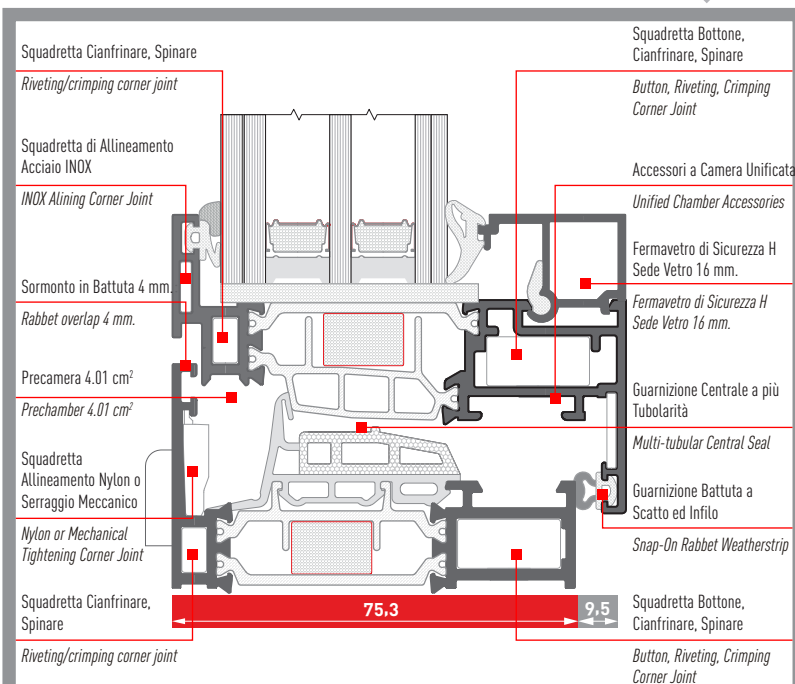

**CARATTERISTICHE FISICHE**

**Tecnologia:**

- Sistema a camera multipla ad elevato isolamento termico con design simmetrico e qualità dell'assemblaggio garantita.
- Spessore dei tamponamenti fino a 55 mm.

**FERRAMENTA:**

- Sistema con accessori funzionali a camera unificata, spazio 11.5 mm. personalizzati ed a pista 16 mm.
- Giunzione angolare con squadrette a bottone/spinare/cianfrinare ed allineamento.

**IMPIEGO:**

- Profilati per finestre che consentono la costruzione di infissi ad una, due o più ante a battente, nella versione a giunto aperto coplanari all'esterno e a sormonto all'interno. Sono possibili anche specchiature fisse, wasistas, anta-ribalta.

**PHYSICAL CHARACTERISTICS**

**Technology:**

- High thermal break multi-glazing system with symmetrical design and guaranteed assembly quality.
- Panel thickness up to 55 mm.

**HARDWARE:**

- System with functional customized accessories with unified chamber, space 11.5 mm and track 16 mm.
- Corner joint with slot joints / dowelling/crimping and trimming.

**USE:**

- Window profiles for the construction of single-, double- or more-casement windows, in the open joint version coplanar on the outside and overlapping on the inside. Mirrored, transom, tilt&turn are also possible.

**CARATTERISTICHE FISICHE | PHYSICAL CHARACTERISTICS**

- ♦ Telaio Fisso | Fixed Frame: **75,3 mm.**
- ♦ Telaio Mobile | Window Frame: **84,8 mm.**
- ♦ Barrette Isolanti | Insulating Rods: **43-49 mm.**
- ♦ Fuga Perimetrale | Perimeter Gap: **5 mm.**
- ♦ Alloggiamento Accessori | Accessories Housing: **Camera Europea dim. 11.5 mm.** [European Chamber]
- ♦ Giunzione Angolare | Corner Joint: **Bottone, Spinare, Cianfrinare** [Dowelling/Crimping and Trimming Riveting Slot]

**PRESTAZIONI CERTIFICATE | CERTIFIED PRERFORMANCES**

- ♦ Permeabilità all'aria | Air Permeability: **Classe 4**
- ♦ Tenuta all'acqua | Watertightness: **Classe E 1500**
- ♦ Carico di vento | Wind load resistance: **Classe C5**
- ♦ Isolamento acustico | Sound Insulation: **fino a 46 dB**
- ♦ Resistenza all'effrazione | Breakage resistance: **Classe RC3**

Risultati dei test / CE product pass conforme ad:  
Tests Results / CE product pass Compliant with:  
UNI EN 14351-1:2006+A1:2010

**■ TRASMITTANZA ■ TRANSMITTANCE**

**SERRAMENTO CAMPIONE | SAMPLE FRAME**

- ♦ Vetro Certificato | Certified Glass: Double Glazing  $U_g = 1.0 \text{ W/(m}^2\text{K)}$
- ♦ Canalina | Duct:  $\psi = 0.036 \text{ W/(m}^2\text{K)}$
- ♦ Finestra normalizzata\* | Normalized Window\*: H = 1480 mm. ed L = 1535 mm.

1 ANTA | Single SASH:  $U_w = 1.14 \text{ W/(m}^2\text{K)}$   
2 ANTE | Double SASH:  $U_w = 1.22 \text{ W/(m}^2\text{K)}$

**SERRAMENTO CAMPIONE | SAMPLE FRAME**

- ♦ Vetro Certificato | Certified Glass: Triple Glazing  $U_g = 0.6 \text{ W/(m}^2\text{K)}$
- ♦ Canalina | Duct:  $\psi = 0.031 \text{ W/(m}^2\text{K)}$
- ♦ Finestra normalizzata\* | Normalized Window\*: H = 1480 mm. ed L = 1535 mm.

1 ANTA | Single SASH:  $U_w = 0.80 \text{ W/(m}^2\text{K)}$   
2 ANTE | Double SASH:  $U_w = 0.89 \text{ W/(m}^2\text{K)}$

\*Dimensioni massime ammesse per il calcolo  $U_w$  su serramento campione fino a 2.3 m<sup>2</sup> (secondo norma UNI EN 14351-1:2006+A1:2010)

\*Maximum allowable dimensions for calculation of the  $U_w$  on sample window frame up to 2.3 m<sup>2</sup> (according to UNI EN 14351-1:2006+A1:2010)

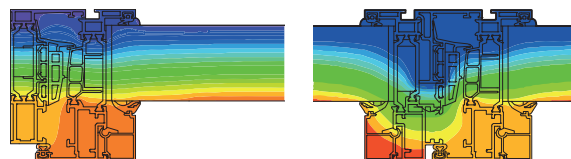

■ Analisi termica con FLIXO vers.8 e WinIso2D Professional 7.8  
■ Thermicon FLIXO vers.8 e WinIso2D Professional 7.8



Agenti Atmosferici | Atmospherics

Tenuta all'Acqua  
Watertightness



Capacità di un inso di impedire infiltrazioni quando è investito da un flusso d'acqua ed è presente una differente pressione tra interno ed esterno.  
Capacity of a window to prevent infiltrations when impacted by a gush of water and there is a different internal and external pressure.

|          |      |     |       |       |       |       |       |       |       |       |       |        |        |        |        |          |
|----------|------|-----|-------|-------|-------|-------|-------|-------|-------|-------|-------|--------|--------|--------|--------|----------|
| Press.   | 0Pa5 | 0Pa | 100Pa | 150Pa | 200Pa | 250Pa | 300Pa | 450Pa | 600Pa | 750Pa | 900Pa | 1050Pa | 1200Pa | 1350Pa | 1500Pa | Pressure |
| Velocità | 03   | 24  | 55    | 56    | 47    | 27    | 89    | 6     | 111   | 126   | 138   | 149    | 159    | 169    | 178    | Speed    |
| Classe   | -1   | A2  | A3    | A4    | A5    | A6    | A7    | A8    | A     | E750  | E900  | E1050  | E1200  | E1350  | E1500  | Class    |

Classe | Class  
**1500\***  
EN 1027 - EN 12208

L'infisso TWIN, con una pressione del vento pari ad una velocità di 178 Km/h (1500Pa) non ha avuto infiltrazioni  
The frame TWIN with a wind pressure equal to a speed of 178 Km/h (1500Pa), had no infiltrations

Tenuta all'Aria  
Air Permeability



Caratteristica di un inso chiuso di lasciare filtrare aria quando è presente una differenza di pressione tra l'interno e l'esterno; minori saranno i volumi dispersi, maggiore sarà la qualità del serramento.  
Characteristic of a closed window to let air filter through when there is a different internal and external pressure; the lower the dispersed volumes, the higher the quality of the frame.

|        |       |       |       |       |          |
|--------|-------|-------|-------|-------|----------|
| Press. | 150Pa | 300Pa | 450Pa | 600Pa | Pressure |
| Classe | 1     | 2     | 3     | 4     | Class    |

L'infisso TWIN ha superato la prova con Pressione Vento = 111 k/h (600Pa)  
The frame TWIN has passed the test with a Wind Pressure = 111 Km/h (600Pa)

Classe | Class  
**4\***  
EN 1026 - EN 12207

Resist. al Vento  
Wind Resistance

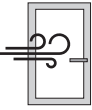

Capacità di un inso sottoposto a forti pressioni e/o depressioni, come quelle causate dal vento, di mantenere una deformazione ammissibile, di conservare le proprietà iniziali a salvaguardia della sicurezza degli utenti.  
Capacity of a window subject to high positive and/or negative pressures, like that caused by the wind, to maintain an admissible deformation, to conserve its initial properties and to safeguard users against breakage.

|           |             |             |             |        |        |         |          |
|-----------|-------------|-------------|-------------|--------|--------|---------|----------|
| Press.    | 400Pa       | 800Pa       | 1200Pa      | 1600Pa | 2000Pa | >2000Pa | Pressure |
| Flessione | A (≤ 1/150) | B (≤ 1/200) | C (≤ 1/300) |        |        |         | Flexure  |
| Classe    | 12          | 34          | 5E          | xxx    |        |         | Class    |

Classe | Class  
**C5\***  
EN 12211-FN 12210

\* Serramento a 2 ante, dimensione L = mm.1495 ed H = mm.1500 - Certificato n° 1994/CPR/RP1837 (Altre Certificazioni Disponibili)  
Double Casement window, dimension L = mm.2034 ed H = mm.1950 - Test certificate no. RP no. 1994/CPR/RP1837 (Other certifications available).  
\*NB = Valori di MX603 con Certificato Estendibilità per MX753 | Values of MX603 with Extensibility Certificate for MX753

Fonoisolamento  
Sound Insulation



Perdita di isolamento acustico rispetto al vetro DR<sub>w</sub> (dB) a partire dalla classe di permeabilità all'aria dell'infisso (UNIEN 12207)  
Capacity of a window to resist violent intrusion following the application of a physical force or with the aid of tools.

|         |     |     |     |     |       |
|---------|-----|-----|-----|-----|-------|
| Classe  | 1   | 2   | 3   | 4   | Class |
| Perdita | 8dB | 6dB | 4dB | 2dB | Loss  |

DR<sub>w</sub> ≤ 38 dB Ammesso l'utilizzo di questo metodo tabellare  
Admitted This table method

DR<sub>w</sub> > 39 dB Necessario realizzare un campione al vero e sottoporre a prove di Laboratorio.  
An actual sample must be made and tested in the laboratory.

Abbattimento Acustico  
Noise Reduction  
**46dB**  
EN ISO140-3 | 717-1

Flusso di calore che passa attraverso il serramento per m2 di superficie e per ogni grado di differenza di temperatura tra interno ed esterno.  
Flow of heat that passes through the window per m2 of surface and for every degree of difference in temperature between outdoors and indoors.

**U<sub>w</sub> 1.14 W/m²K**  
Finestra a 2 ante normalizzata (1535 mm. x 1480 mm; vetro doppio U<sub>g</sub> = 1.0 W/m²K certificato con canalina psi = 0.036 W/m²K)  
Normalised 2 Sashes window (1535 mm x 1480 mm; double glazing U<sub>g</sub> = 1.0 W/m²K certified with duct psi = 0.036 W/m²K)

**U<sub>w</sub> 0,89 W/m²K**  
Finestra a 2 ante normalizzata (1535 mm. x 1480 mm; vetro triplo U<sub>g</sub> = 0.6 W/m²K certificato con canalina psi = 0.031 W/m²K)  
Normalised 2 Sashes window (1535 mm x 1480 mm; double glazing U<sub>g</sub> = 0.6 W/m²K certified with duct psi = 0.031 W/m²K)

Effrazione | Breakeage

Antieffrazione  
Breakeage Resistance



Capacità di un infisso di resistere ad un'intrusione violenta a seguito di una applicazione di una forza fisica e con l'aiuto di attrezzi Finestra a 2 ante (1230 mm. x 1480 mm) - CERTIFICATO CP384-VAL-3400A.52  
Capacity of a window to resist violent intrusion following the application of a physical force or with the aid of tools. 2 sashes window (1230 mm x 1480 mm) - CP384-VAL-3400A.52 CERTIFIED door

|            |   |   |                     |
|------------|---|---|---------------------|
| Classe     | <b>RC1</b>  | <b>RC2</b>                                | <b>RC3</b>          |
| Intrusione | Forza Fisica (Calci Pugni, Spallate)                      | Semplice Attrezzatura (Cunei, Cacciaviti) | R2 + Piede di Porco |
| Intrusion  | Physical strength (kicks, pushing, pushing with shoulder) | Simple Tools (Wedges, Screwdrivers)       | R2 + Crowbar        |

L'infisso TWIN, resiste in modo efficace ai tentativi di intrusione interna.  
The TWIN window effectively resists attempted breakins

Resistenza Effrazione  
Breakeage Resistance  
**RC 3**

Resistenze Meccaniche | Mechanical Strenght

Azionamento  
Handling

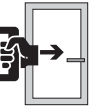

Classe **0 1 2** Classe L'infisso TWIN consente grande facilità di apertura con uno sforzo minimo  
Forza Force The frame TWIN allows easy opening with minimal effort

Classe | Class  
**1**  
EN 13115

Forze Applicate  
Applied Forces

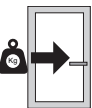

Resistenza di un infisso a carichi applicati senza riportare rotture, deformazioni permanenti o torsioni tali da pregiudicare il suo corretto esercizio  
Capacity of a window to resist applied loads without torsion, permanent deformation or breakage undermining its correct functioning.

|                  |          |          |          |          |                |
|------------------|----------|----------|----------|----------|----------------|
| Classe           | <b>1</b> | <b>2</b> | <b>3</b> | <b>4</b> | Class          |
| Carico Verticale | 200 N    | 400 N    | 600 N    | 800 N    | Vertical Load  |
| Torsione Statica |          |          |          |          | Static Torsion |

L'infisso TWIN resiste ai carichi applicati senza torsioni, deformazioni permanenti o rotture.  
The frame TWIN is resistant to applied loads without torsion, permanent deformation or breakage.

Classe | Class  
**4**  
EN 13115 EN 12046

Cicli di Utilizzo  
Cycles of Use

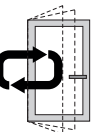

Capacità di un infisso di resistere nel tempo a ripetuti cicli di Apertura e Chiusura | Capacity of a window to resist opening and closing cycles over time.

|          |            |            |            |              |
|----------|------------|------------|------------|--------------|
| Grado    | <b>3</b>   | <b>4</b>   | <b>5</b>   | Grade        |
| N° Cicli | 10'000 A/C | 15'000 A/C | 25'000 A/C | N. of Cycles |

L'infisso TWIN resiste ai cicli di Apertura e Chiusura  
The TWIN window effectively resists opening and closing cycles.

Grado | Grade  
**5**  
EN 1326 - 4

Urti  
Impacts



Capacità di un infisso di resistere in caso di Urti involontari o accidentali | Capacity of a window to resist in the case of involuntary or accidental impacts.

|                |          |          |          |          |          |             |
|----------------|----------|----------|----------|----------|----------|-------------|
| Classe         | <b>1</b> | <b>2</b> | <b>3</b> | <b>4</b> | <b>5</b> | Class       |
| Altezza Caduta | 200mm.   | 300 mm.  | 450 mm.  | 700 mm.  | 950 mm.  | Drop Height |

L'infisso TWIN resiste efficacemente agli Urti [Metodo di Prova con "CORPO DURO"]  
The TWIN effectively resists impacts. ["HEAVY BODY" Test Method]

Classe | Class  
**1**  
EN 13115 EN 12046

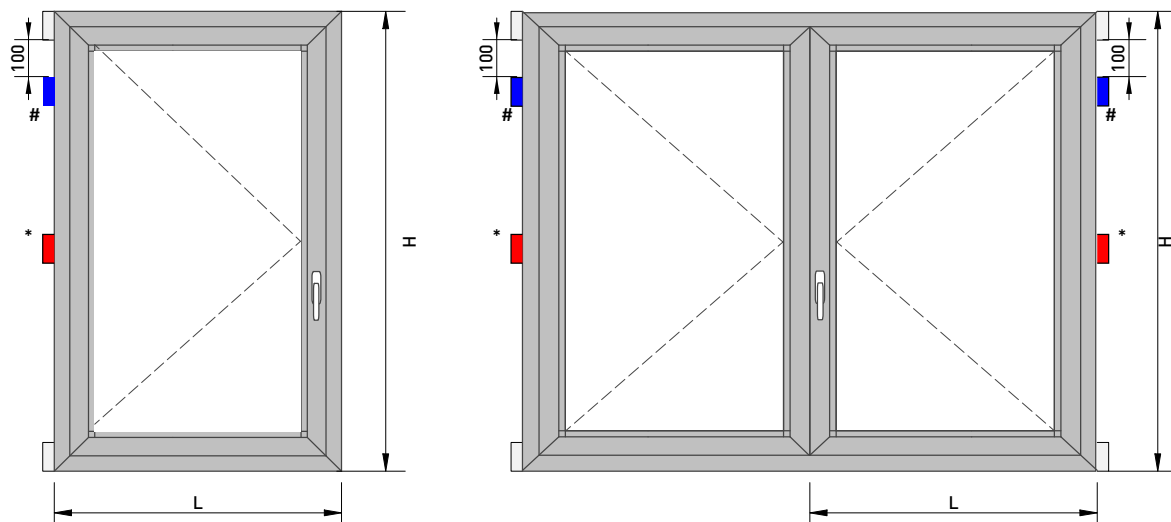
**Battente una e Due Ante Cerniere: ACX 02.01 e ACX 02.03**
*Single and Double Sash Casement Window Hinges: ACX 02.01 e ACX 02.03*

■ **Dimensioni Anta Minima (LxH):** ■ *Minimum Sash Dimension (WxH):*  
**430 mm. x 500 mm.**

**Norma per Stringa di Prodotto / Standard for Product String: EN 1935:2004**

| Tipo<br>Type     | (1) Cat. D'Uso<br>Cat. of Use | (2) Durabilità<br>Durability | (3) Massa<br>Mass | (4) Resist. Fuoco<br>Fire Resistance | (5) Sicurezza D'Uso<br>Safety of Use | (6) Resist. Corrosione<br>Corrosion Resist. | (7) Resist. Effrazione<br>Breakage Resist. | (8) Grado<br>Degree |
|------------------|-------------------------------|------------------------------|-------------------|--------------------------------------|--------------------------------------|---|--|---------------------|
| <b>ACX 02.01</b> | <b>1</b>                      | <b>4</b>                     | <b>2 (80Kg)</b>   | <b>0</b>                             | <b>1</b>                             | <b>4</b>                                    | <b>0</b>                                   | <b>6</b>            |
| <b>ACX 02.03</b> | <b>1</b>                      | <b>4</b>                     | <b>3 (80Kg)</b>   | <b>0</b>                             | <b>1</b>                             | <b>4</b>                                    | <b>0</b>                                   | <b>9</b>            |

**Dimensioni Massime Anta (LxH) / Maximum Sash Size (WxL)**

| <b>Anta Singola 2 Cerniere</b><br><i>Single Sash 2 Hinges</i> | <b>Anta Singola 3 Cerniere</b><br><i>Single Sash 3 Hinges</i> | <b>Anta Singola 4 Cerniere * + #</b><br><i>Single Sash 4 Hinges * + #</i> |
|---|---|---|
| <b>1000x1600 mm.</b>  | <b>1200x1800 mm.</b>  | <b>1300x2100 mm.</b>  |
| <b>Due Ante 2 Cerniere</b><br><i>Double Sash 2 Hinges</i>     | <b>Due Ante 3 Cerniere</b><br><i>Double Sash 3 Hinges</i>     | <b>Due Ante 4 Cerniere * + #</b><br><i>Double Sash 4 Hinges * + #</i>     |
| <b>1000x1500 mm.</b>  | <b>1000x1700 mm.</b>  | <b>1000x2100 mm.</b>  |

**Legenda Stringa di Prodotto / Product String Key**

| (1) Cat. D'Uso<br>Cat. of Use          | (2) Durabilità<br>Durability | (3) Massa<br>Mass | (4) Resist. Fuoco<br>Fire Resistance         | (5) Sicurezza D'Uso<br>Safety of Use | (6) Resist. Corrosione<br>Corrosion Resist.   | (7) Effrazione<br>Breakage | (8) Grado<br>Degree  |
|--|------------------------------|-------------------|--|--------------------------------------|---|----------------------------|--|
| <b>1= Leggero</b><br><i>Lightweigh</i> | <b>3:10'000</b>              | <b>2: 40Kg</b>    | <b>0:</b> Non Idoneo.<br><i>Not Suitable</i> | <b>1:</b> Soddisfatto.<br><i>Met</i> | <b>4:</b> 240h in nebbia<br>salina in accordo a<br>UNI EN 1670:2008.<br><br><i>240h in salt spray in<br/>accordance with<br/>UNI EN 1670:2008</i> | <b>1</b>                   | <b>Valore:</b><br>Combinazione di<br>Massa e cicli.<br><i>Combination of<br/>Mass and Cycles</i> |
| <b>2= Medio</b><br><i>Medium</i>       | <b>4:25.000</b>              | <b>3: 60 Kg</b>   |  |                                      |   |                            |  |
| <b>3= Pesante</b><br><i>Heavy</i>      | <b>7:200.000</b>             | <b>4: 80 Kg</b>   | <b>1:</b> Idoneo.<br><i>Met</i>              |                                      |   |                            |  |
| <b>4= Intenso</b><br><i>vintense</i>   |                              | <b>5: 100 Kg</b>  |  |                                      |   |                            |  |

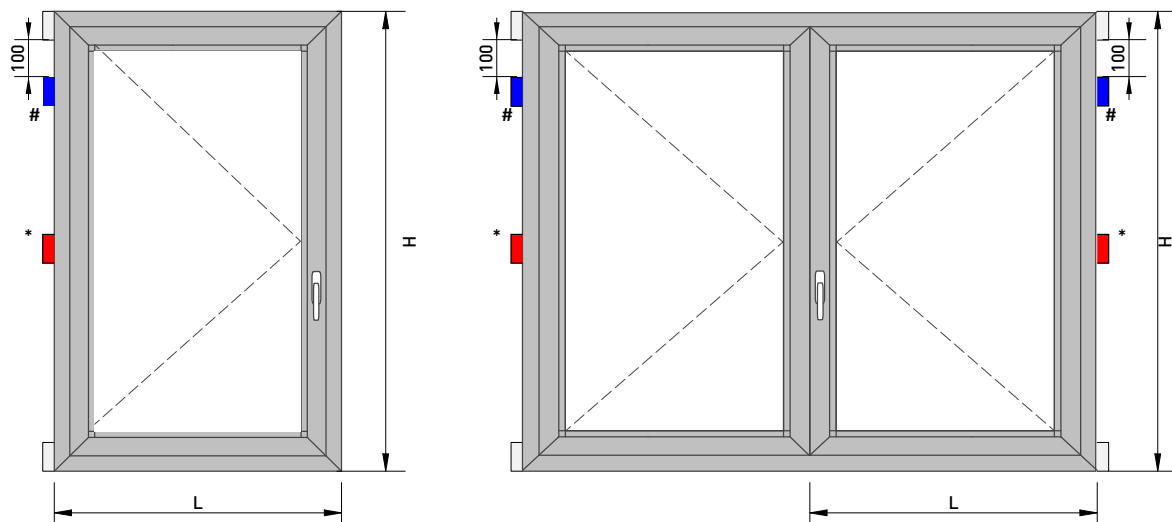
 Battente Una e Due Ante **Cerniere a pettine: ACX 08.09**
*Single and Double Casement Window* **Comb Hinges: ACX 08.09**

■ **Dimensioni Anta Minima (LxH):** ■ *Minimum Sash Dimension (WxH):*  
**430 mm. x 500 mm.**

**Norma per Stringa di Prodotto / Standard for Product String: EN 1935:2004**

| Tipo<br>Type    | (1) Cat. D'Uso<br>Cat. of Use | (2) Durabilità<br>Durability | (3) Massa<br>Mass | (4) Resist. Fuoco<br>Fire Resistance | (5) Sicurezza D'Uso<br>Safety of Use | (6) Resist. Corrosione<br>Corrosion Resist. | (7) Resist. Effrazione<br>Breakage Resist. | (8) Grado<br>Degree |
|-----------------|-------------------------------|------------------------------|-------------------|--------------------------------------|--------------------------------------|---|--|---------------------|
| <b>ACX08.09</b> | <b>2</b>                      | <b>7</b>                     | <b>2 (80Kg)</b>   | <b>0</b>                             | <b>1</b>                             | <b>4</b>                                    | <b>0</b>                                   | <b>7</b>            |

**Dimensioni Massime Anta (LxH) / Maximum Sash Size (WxL)**

| <b>Anta Singola 2 Cerniere</b><br><i>Single Sash 2 Hinges</i> | <b>Anta Singola 3 Cerniere</b><br><i>Single Sash 3 Hinges</i> | <b>Anta Singola 4 Cerniere * + #</b><br><i>Single Sash 4 Hinges * + #</i> |
|---|---|---|
| <b>1000x1600 mm.</b>  | <b>1200x1800 mm.</b>  | <b>1300x2100 mm.</b>  |
| <b>Due Ante 2 Cerniere</b><br><i>Double Sash 2 Hinges</i>     | <b>Due Ante 3 Cerniere</b><br><i>Double Sash 3 Hinges</i>     | <b>Due Ante 4 Cerniere * + #</b><br><i>Double Sash 4 Hinges * + #</i>     |
| <b>1000x1500 mm.</b>  | <b>1000x1700 mm.</b>  | <b>1000x2100 mm.</b>  |

**Legenda Stringa di Prodotto / Product String Key**

| (1) Cat. D'Uso<br>Cat. of Use          | (2) Durabilità<br>Durability | (3) Massa<br>Mass | (4) Resist. Fuoco<br>Fire Resistance         | (5) Sicurezza D'Uso<br>Safety of Use | (6) Resist. Corrosione<br>Corrosion Resist.   | (7) Effrazione<br>Breakage | (8) Grado<br>Degree  |
|--|------------------------------|-------------------|--|--------------------------------------|---|----------------------------|--|
| <b>1= Leggero</b><br><i>Lightweigh</i> | <b>3:10'000</b>              | <b>2: 40Kg</b>    | <b>0:</b> Non Idoneo.<br><i>Not Suitable</i> | <b>1:</b> Soddisfatto.<br><i>Met</i> | <b>4:</b> 240h in nebbia<br>salina in accordo a<br>UNI EN 1670:2008.<br><br><i>240h in salt spray in<br/>accordance with<br/>UNI EN 1670:2008</i> | <b>1</b>                   | <b>Valore:</b><br>Combinazione di<br>Massa e cicli.<br><i>Combination of<br/>Mass and Cycles</i> |
| <b>2= Medio</b><br><i>Medium</i>       | <b>4:25.000</b>              | <b>3: 60 Kg</b>   |  |                                      |   |                            |  |
| <b>3= Pesante</b><br><i>Heavy</i>      | <b>7:200.000</b>             | <b>4: 80 Kg</b>   | <b>1:</b> Idoneo.<br><i>Met</i>              |                                      |   |                            |  |
| <b>4= Intenso</b><br><i>vintense</i>   |                              | <b>5: 100 Kg</b>  |  |                                      |   |                            |  |



Aperture Oscillo battenti (140 Kg.) Una e Due Ante **Cerniere: ACX 08.01 e ACX 08.01L**

*Tilt&turn Openings (140 Kg.) Single and Double Sash* **Hinges: ACX.08.01 and ACX.08.01L**

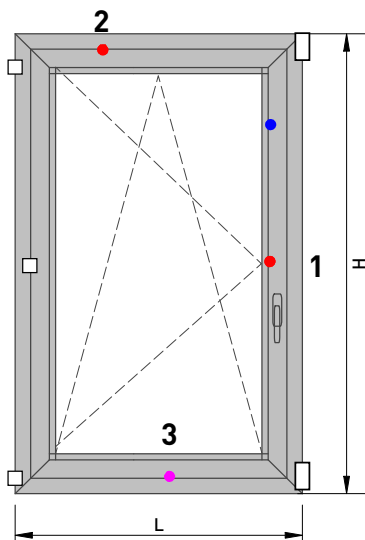

Punti di chiusura | *Locking Points*

su KIT base / on Base KIT

□ ARX 08.01    ◆ □ ARX 08.01L

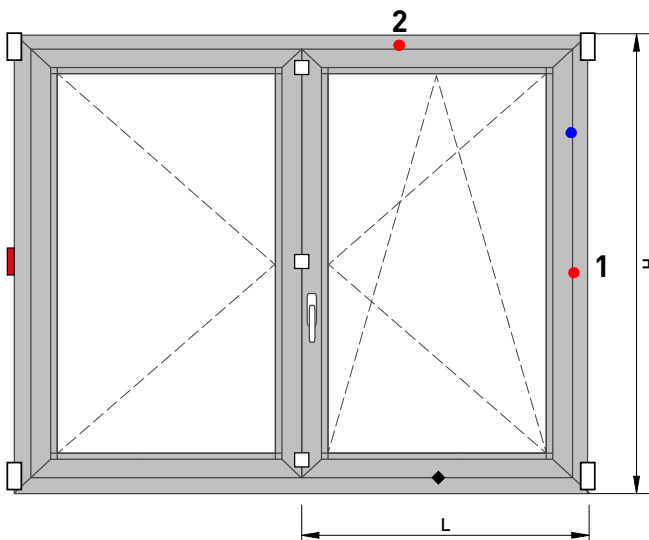

Punti di chiusura Supplementari | *Additional Locking Points*

su KIT base / on Base KIT

● ARX 08.06    ● ARX 08.16    ● ARX 08.16

**Norma per Stringa di Prodotto / Standard for Product String: EN 13126-8:2006**

| Tipo Type  | (1) Cat. D'Uso Cat. of Use | (2) Durabilità Durability | (3) Massa Mass | (4) Resist. Fuoco Fire Resistance | (5) Sicurezza D'Uso Safety of Use | (6) Corrosione Corrosion | (7) Effrazione Breakage | (8) Applicazione Application | (9) Dim Provino Test Size |
|------------|----------------------------|---------------------------|----------------|-----------------------------------|-----------------------------------|--------------------------|-------------------------|------------------------------|---------------------------|
| ACX 08.01  | -                          | 4                         | 140 Kg         | 0                                 | 1                                 | 4                        | -                       | 11                           | 1550x1400                 |
| ACX 08.01L | -                          | 4                         | 140 Kg         | 0                                 | 1                                 | 4                        | -                       | 12                           | 1550x1400                 |

**Limiti Dimensionali per Braccio Corto | Size Limits for Short Arm: ACX 08.22 | ACX 08.22L**

|     | Anta Singola (LxH)<br><i>Single Sash (WxL)</i> | Anta Doppia (LxH)<br><i>Double Sash (WxL)</i> | Punti di Chiusura<br><i>Locking Points</i> |
|-----|--|---|--|
| MIN | 395x500 mm.                                    | 395x500 mm.                                   | ACX 08.01 - ACX 08.01L                     |
| MAX | 450x500 mm.                                    | 450x500 mm.                                   | ACX 08.01 - ACX 08.01L                     |

**Limiti Dimensionali per Braccio Medio | Size Limits for Medium Arm: ACX 08.03 | ACX 08.22L**

|     | Anta Singola (LxH)<br><i>Single Sash (WxL)</i> | Anta Doppia (LxH)<br><i>Double Sash (WxL)</i> | Punti di Chiusura<br><i>Locking Points</i> |
|-----|--|---|--|
| MIN | 451x500 mm.                                    | 451x500 mm.                                   | ACX 08.01 - ACX 08.01L                     |
| MAX | 650x1200 mm.                                   | 650x1200 mm.                                  | KIT + ACX 08.06                            |
| MAX | 650x2200 mm.                                   | 650x2200 mm.                                  | KIT + ACX 08.06 + ACX 08.16                |

**Limiti Dimensionali per Braccio Corto | Size Limits for Short Arm: ACX 08.24 | ACX 08.24L**

|     | Anta Singola (LxH)<br><i>Single Sash (WxL)</i> | Anta Doppia (LxH)<br><i>Double Sash (WxL)</i> | Punti di Chiusura<br><i>Locking Points</i> |
|-----|--|---|--|
| MIN | 651x600 mm.                                    | 651x600 mm.                                   | ACX 08.01 - ACX 08.01L                     |
| MAX | 651x1400 mm.                                   | 651x1400 mm.                                  | ACX 08.01 - ACX 08.06                      |
| MAX | 651x2200 mm.                                   | 651x2200 mm.                                  | KIT + ACX 08.06 - ACX 08.16                |
| MAX | 1200x1400 mm.                                  | 1200x1400 mm.                                 | KIT + ACX 08.06 - ACX 08.16 [Qt. x2]       |
| MAX | 1200x2200 mm.                                  | 1200x2200 mm.                                 | KIT + ACX 08.06 - ACX 08.16 [Qt. x3]       |
| MAX | 1200x2200 mm.                                  | -   | KIT + ACX 08.06 - ACX 08.16 [Qt. x3]       |
| MAX | 1200x2200 mm.                                  | -   | -  |

**Legenda Stringa di Prodotto / Product String Key**

| (1) Cat. D'Uso Cat. of Use | (2) Durabilità Durability                                      | (3) Massa Mass  | (4) Resist. Fuoco Fire Resistance  | (5) Sicurezza D'Uso Safety of Use | (6) Corrosione Corrosion                            | (7) Effrazione Breakage | (8) Applicazione Application    | (9) Dim Provino Test Size                              |
|----------------------------|--|---|------------------------------------|-----------------------------------|---|-------------------------|---------------------------------|--|
| -                          | <b>4:15,000</b><br><b>a/r+5,000</b><br><b>Battente</b> (Swing) | <b>Portata</b><br><b>Certificata</b><br>(Certification Scope) | <b>0: Non Idoneo</b><br>0: Not Met | <b>1: Soddisfatto</b><br>1: Met   | <b>4: 240h</b><br><b>UNI EN</b><br><b>1670:2008</b> | -                       | <b>8: Privato</b><br>8: Private | <b>Dimensioni</b><br><b>Campione</b><br>Test Dimension |





| TIPOLOGIA   TIPE |                             | PROFILI   PROFILES          |  |
|------------------|-----------------------------|-----------------------------|--|
|                  | <b>MX753.201</b>            |                             |  |
|                  | $J_x$ 45.82 cm <sup>4</sup> | $W_x$ 10.30 cm <sup>3</sup> |  |
|                  | $J_y$ 6.220 cm <sup>4</sup> | $W_y$ 1.980 cm <sup>3</sup> |  |
|                  | <b>MX753.202</b>            |                             |  |
|                  | $J_x$ 43.25 cm <sup>4</sup> | $W_x$ 9.440 cm <sup>3</sup> |  |
|                  | $J_y$ 5.180 cm <sup>4</sup> | $W_y$ 1.700 cm <sup>3</sup> |  |
|                  | <b>MX753.235</b>            |                             |  |
|                  | $J_x$ 40.86 cm <sup>4</sup> | $W_x$ 8.49 cm <sup>3</sup>  |  |
|                  | $J_y$ 4.91 cm <sup>4</sup>  | $W_y$ 1.64 cm <sup>3</sup>  |  |

| Pressione Vento<br>Wind Pressure : 1200(Pa)   |                      | Dimensione MIN<br>MIN Dimension | Dimensione MAX<br>MAX Dimension |
|---|----------------------|---------------------------------|---------------------------------|
| <b>Finestra 1 Anta</b><br>1 Sash Window       | L (Anta)<br>L (Sash) | 430                             | 1100                            |
|   | H (Anta)<br>H (Sash) | 700                             | 1700                            |
| <b>Porta Finestra 1 Anta</b><br>1 Sash Window | L (Anta)<br>L (Sash) | 430                             | 1200                            |
|   | H (Anta)<br>H (Sash) | 750                             | 2000                            |

| TIPOLOGIA   TIPE |                             | PROFILI   PROFILES          |  |
|------------------|-----------------------------|-----------------------------|--|
|                  | <b>MX753.201</b>            |                             |  |
|                  | $J_x$ 45.82 cm <sup>4</sup> | $W_x$ 10.30 cm <sup>3</sup> |  |
|                  | $J_y$ 6.220 cm <sup>4</sup> | $W_y$ 1.980 cm <sup>3</sup> |  |
|                  | <b>MX753.202</b>            |                             |  |
|                  | $J_x$ 43.25 cm <sup>4</sup> | $W_x$ 9.440 cm <sup>3</sup> |  |
|                  | $J_y$ 5.180 cm <sup>4</sup> | $W_y$ 1.700 cm <sup>3</sup> |  |
|                  | <b>MX753.235</b>            |                             |  |
|                  | $J_x$ 40.86 cm <sup>4</sup> | $W_x$ 8.49 cm <sup>3</sup>  |  |
|                  | $J_y$ 4.91 cm <sup>4</sup>  | $W_y$ 1.64 cm <sup>3</sup>  |  |

| Pressione Vento<br>Wind Pressure : 1200(Pa)     |                      | Dimensione MIN<br>MIN Dimension | Dimensione MAX<br>MAX Dimension |
|---|----------------------|---------------------------------|---------------------------------|
| <b>Finestra 2 Ante</b><br>2 Sashes Window       | L (Anta)<br>L (Sash) | 430                             | 1200                            |
|   | H (Anta)<br>H (Sash) | 700                             | 1700                            |
| <b>Porta Finestra 2 Ante</b><br>2 Sashes Window | L (Anta)<br>L (Sash) | 430                             | 1200                            |
|   | H (Anta)<br>H (Sash) | 750                             | 2000                            |



## LA MARCATURA CE DELLE FINESTRE E PORTE PEDONALI [Senza caratteristiche di resistenza al fuoco e/o di tenuta al fumo]

Il marchio CE, apposto sui prodotti da costruzione, attesta la loro conformità ai requisiti essenziali definiti dalla direttiva 89/106/CE "Prodotti da costruzione", emanata dal Consiglio della Comunità Europea il 21/12/1988 ed attuata, in Italia, dal D.P.R. n. 246 del 21/04/1993. La marcatura CE di uno specifico prodotto da costruzione diviene obbligatoria, al fine di immettere il prodotto in un mercato della Comunità Europea, allorché sia stata emessa dal CEN, su mandato della Comunità Europea, una "specificazione tecnica" (norma o benessere tecnico) che regolamenti la sua applicazione.

La responsabilità per la verifica dei requisiti del prodotto e per l'apposizione della marcatura CE spetta al suo fabbricante. Al fine di garantire i requisiti richiesti dalle relative norme, il fabbricante è tenuto a:

- ◆ **Predisporre un piano di controllo della produzione (FPC). E' un sistema di procedure e controlli da eseguire durante le fasi di produzione**
- ◆ **Effettuare delle "prove iniziali di tipo" (ITT) sul prodotto al fine di determinare le prestazioni. Le modalità di prova dei requisiti del prodotto sono definite dalle norme richiamate dalla specifica norma prodotto".**

Alcune prove possono essere eseguite dal produttore stesso, secondo le disposizioni delle relative norme armonizzate, mentre altri requisiti sono di competenza di laboratori in possesso di una notifica attribuita loro dallo stato membro di appartenenza (organismi notificati).

### IL FABBRICANTE PUO' PROCEDERE IN PIU' MODI

- ◆ **Eseguire autonomamente i test sui propri prodotti presso un istituto Notificato, diventando quindi titolare degli ITT**
- ◆ **Far riferimento ai risultati di prove effettuate dal detentore del sistema di serramento, purché quest'ultimo abbia espresso il proprio consenso per mezzo di un contratto di licenza d'uso stipulato tra le parti.**

Da Febbraio 2010 è obbligatoria la marcatura CE per finestre e porte pedonabili senza caratteristiche di resistenza al fuoco e tenuta al fumo.

**L'appendice ZA della norma UNI EN 14351-1 specifica le caratteristiche essenziali per finestre e porte e attribuisce le competenze delle prove iniziali di tipo.**

Il requisito relativo ad una determinata caratteristica non è applicabile in quegli Stati Membri nei quali non sussistono requisiti di regolamentazione per tale caratteristica per l'impiego previsto del prodotto. In questo caso, i fabbricanti che immettono i loro prodotti sul mercato di questi Stati membri non sono obbligati a determinare né a dichiarare le prestazioni dei loro prodotti in relazione a questa caratteristica e può essere utilizzata l'opzione "Nessuna Prestazione Determinata" (NPD) nelle informazioni che accompagnano la marcatura CE (vedere punto ZA.3). Tuttavia, l'opzione NPD non può essere utilizzata nel caso in cui la caratteristica sia soggetta a un livello soglia. (Citazione integrale tratta dalla norma UNI EN 14351-1 - appendice ZA)

## CE MARKING OF PEDESTRIAN WINDOWS AND DOORS [Without fire resistance and/or smoke resistance characteristics]

*The CE marking, affixed to products, certifies their compliance with the essential requirements of Directive 89/106/EC "Construction products", issued by the Council of the European Community on 21/12/1988 and implemented, in Italy, by Presidential Decree no. 246 of 21/04/1993. The CE marking of a specific product is mandatory when the product is to be placed on a European Community market, whenever a "technical specification" (standard or technical approval) that regulates its application has been issued by CEN, under mandate of the European Community.*

*The manufacturer is responsible for verifying product requirements and affixing the CE marking. To ensure fulfilment of the requirements of the relevant standards, the manufacturer must:*

- ◆ *Draw up a production control plan (PCP). This system of procedures and controls are performed during the production stages.*
- ◆ *Carry out "initial type tests" (ITT) on the product in order to determine performance. The test methods of the product requirements are defined by the standards referred to in the specific product standard ".*

*Some tests can be carried out by the manufacturer, in accordance with the provisions of the relevant harmonised standards, while others are the responsibility of laboratories awarded notified body status by their Member State (notified bodies).*

### THE MANUFACTURER MAY PROCEED IN SEVERAL WAYS:

- ◆ *Carry out the tests on its products independently at a Notified Body, thus becoming the holder of the ITTs*
- ◆ *Refer to the results of tests carried out by the holder of the window and door system, provided that the latter has given his consent by means of a user licence agreement signed by the parties.*

*From February 2010, CE marking is mandatory for pedestrian windows and doors without fire resistance and smoke resistance characteristics. Appendix ZA of standard UNI EN 14351-1 specifies the essential characteristics for windows and doors and attributes responsibilities for the initial type tests.*

*The requirement for a given characteristic does not apply in the Member States where there are no regulatory requirements for that characteristic for the intended use of the product. In this case, manufacturers who place their products on the market of these Member States shall not be obliged to determine or to declare the performance of their products for same characteristic and the "No Performance Determined" (NPD) option may be used in the information accompanying the CE marking (see point ZA.3). However, the NPD option cannot be used when the characteristic is subject to a threshold level. (Full quote from UNI EN 14351-1 - Appendix ZA)*



Per finestre e porte senza funzione di compartimentazione del fuoco o fumo e non poste nelle vie di fuga (sistema di attestazione della conformità 3):

For windows and doors without a fire or smoke compartmentalization function and not located in run off areas (conformity attestation system 3):

| CARATTERISTICHE FONDAMENTALI<br>FUNDAMENTAL CHARACTERISTICS   | Espressioni di<br>Prestazione<br>Expressions of<br>Performance | Competenze Prove Iniziali Tipo   Initial Type Test Responsibilities           |               |                            |
|---|--|---|---------------|----------------------------|
|   |  | ON= Organismo Notificato; PR= Produttore   ON=Notified Body; PR= Manufacturer |               |                            |
|   |  | Finestre   Windows  | Porte   Doors | Lucernari   Hopper Windows |
| <b>Comportamento al FUOCO Dall'Esterno</b><br><i>External Fire Behaviour</i>                                  |  |   |               | <b>ON</b>                  |
| <b>Resistenza al FUOCO</b><br><i>Fire Reaction</i>  | <b>Euroclassi</b><br><i>Euroclasses</i>                        |   |               | <b>ON</b>                  |
| <b>Tenuta all'ACQUA</b><br><i>Watertightness</i>  | <b>Classi Tecniche</b><br><i>Technical Classes</i>             | <b>ON</b>   | <b>ON</b>     | <b>ON</b>                  |
| <b>Sostanze Pericolose</b><br><i>Hazardous Substances</i>   |  | <b>ON</b>   | <b>ON</b>     |                            |
| <b>Resistenza al Carico del VENTO</b><br><i>Wind Load Resistance</i>  | <b>Classi Tecniche</b><br><i>Technical Classes</i>             | <b>ON</b>   | <b>ON</b>     | <b>PR</b>                  |
| <b>Resistenza al Carico della NEVE e Carico Premanente</b><br><i>Snow Load and Permenent Load</i>             | <b>Classi Tecniche</b><br><i>Technical Classes</i>             |   |               | <b>PR</b>                  |
| <b>Resistenza all'URTO</b><br><i>Shock Resistance</i>   | <b>KN/m<sup>2</sup></b><br><i>KN/sqm</i>                       |   | <b>PR</b>     | <b>ON</b>                  |
| <b>Capacità Portante dei Dispositivi di Sicurezza</b><br><i>Load-bearing Capacity of Savety evices</i>        | <b>Soglia</b>  | <b>ON</b>   | <b>ON</b>     | <b>ON</b>                  |
| <b>Altezza</b><br><i>Height</i>   | <b>mm.</b>   |   | <b>PR</b>     |                            |
| <b>Forze di azionamento (solo dispositivi automatici)</b><br><i>Operating forces (automatic devices only)</i> | <b>Classi Tecniche</b><br><i>Technical Classes</i>             |   | <b>ON</b>     |                            |
| <b>Prestazione acustica</b><br><i>Acoustic Performance</i>  | <b>dB</b>  | <b>ON</b>   | <b>ON</b>     | <b>ON</b>                  |
| <b>Trasmittanza termica</b><br><i>Heat Transmittance</i>  | <b>W/m<sup>2</sup>K</b>  | <b>ON</b>   | <b>ON</b>     | <b>ON</b>                  |
| <b>Proprietà radioattive</b><br><i>Radioactive properties</i>   |  |   |               | <b>PR</b>                  |
| <b>Permeabilità all'ARIA</b><br><i>AIR Permeability</i>   | <b>Classi Tecniche</b><br><i>Technical Classes</i>             | <b>ON</b>   | <b>ON</b>     | <b>PR</b>                  |

La valutazione delle caratteristiche da dichiarare è funzione della destinazione d'uso del prodotto e della legislazione vigente nello Stato Membro, ove esso è immesso.

The characteristics to be declared depend on the intended use of the product and the legislation in force in the Member State where it is sold.



## TEST INIZIALI di TIPO (ITT)

La serie riportata nel presente catalogo è stata sottoposta a test iniziali di tipo (ITT) relativamente ai requisiti previsti dalla norma prodotto UNI EN 14351-1.

I risultati dei test iniziali di tipo sono estendibili a serramenti di differente tipologia e con differenti dimensioni e componenti, secondo le indicazioni fornite dalla norma EN 14351-1 in Appendice A (interdipendenza fra le caratteristiche e i componenti), Appendice E (determinazione delle caratteristiche) ed Appendice F (selezione facoltativa di provini rappresentativi per le finestre)

Il costruttore di serramenti ha la responsabilità di verificare la rispondenza del serramento prodotto rispetto al campione sottoposto a prova. Il consorzio TWIN Systems mette a disposizione dei propri clienti i risultati dei test effettuati, a seguito della stipulazione di un contratto d'uso gratuito degli stessi.

### Dichiarazione di Conformità

Il fabbricante del serramento è tenuto a consegnare al committente una dichiarazione di conformità la quale, in accordo alla norma UNI EN 14351-1, deve includere :

- ◆ Nome ed indirizzo del fabbricante o del suo rappresentante autorizzato con sede nella EEA;
- ◆ Descrizione del prodotto (tipo, identificazione, impiego, ecc.) e una copia delle informazioni che accompagnano la marcatura CE;
- ◆ Disposizioni alle quali il prodotto è conforme ( appendice AZ della norma prodotto UNI EN 14351-1);
- ◆ Condizioni particolari applicabili all'impiego del prodotto (per esempio disposizioni per l'impiego in determinante condizioni, ecc.);
- ◆ Nome e indirizzo del/i laboratorio/i approvato/i.
- ◆ Nome e qualifica della persona incaricata di firmare la dichiarazione per conto del fabbricante o del suo rappresentante autorizzato.

La dichiarazione e il certificato devono essere presentati nella lingua o nelle lingue ufficiali dello Stato Membro in cui il prodotto deve essere utilizzato.

### Etichettatura e Marcatura

Il fabbricante deve fornire informazioni sufficienti ad assicurare la rintracciabilità del suo prodotto fornendo il collegamento fra il prodotto, il fabbricante e la produzione. Queste informazioni devono essere contenute su un'etichetta o specificate in documenti di accompagnamento nelle specifiche tecniche pubblicate dal fabbricante. Le informazioni seguenti devono accompagnare il simbolo di marcatura CE:

- ◆ Nome e indirizzo registrato o marchio di identificazione del fabbricante;
- ◆ Ultime due cifre dell'anno in cui la marcatura CE è stata applicata;
- ◆ Riferimento alla norma di prodotto (EN 14351-1);
- ◆ Descrizione del prodotto: nome generico, materiale, dimensioni, ecc. e impiego previsto;
- ◆ Informazioni sulle caratteristiche essenziali che devono essere dichiarate presentate come:
- ◆ Valori dichiarati o livelli e/o classi;
- ◆ NPD - " Nessuna prestazione determinata" per le caratteristiche quando è pertinente.

## INITIAL TYPE TESTS (ITT)

The series in this catalogue has been subjected to initial type tests (ITT) for the requirements of product standard UNI EN 14351-1. The results of the initial type tests can be extended to doors and windows of different types and of different sizes and compositions, according to the indications provided for by EN 14351-1 in Appendix A (interdependence between the characteristics and compositions), Appendix E (determination of characteristics) and Appendix F (optional selection of representative samples for the windows).

The door and window manufacturer is responsible for verifying compliance of the window with the sample under test. The TWIN Systems consortium makes the results of the test performed available to its customer, after the free usage agreement has been signed.

### Declaration of Conformity

The window and door manufacturer must provide the customer with a declaration of conformity which, in accordance with UNI EN 14351-1, must include:

- ◆ Name and address of the manufacturer or its authorised representative established in the EEA;
- ◆ Description of the product (type, identification, use, etc.) and a copy of the information accompanying the CE marking;
- ◆ Provisions with which the product complies (Appendix AZ of product standard UNI EN 14351-1);
- ◆ Special conditions applicable to the use of the product (e.g. provisions for use under certain conditions, etc.);
- ◆ Name and address of the approved laboratory(ies).
- ◆ Name and capacity of the person empowered to sign the declaration on behalf of the manufacturer or his authorised representative.

The declaration and certificate must be done in the official language or languages of the Member State where the product is to be used.

### Labelling and Marking

The manufacturer must provide sufficient information to ensure the traceability of the product providing the link between the product, the manufacturer and the production. This information must be contained on a label or specified in accompanying documents in the technical specifications published by the manufacturer. The following information must accompany the CE marking symbol:

- ◆ Manufacturer's name and registered address or identification mark; Last two digits of the year in which the CE marking was applied; Reference to the product standard (EN 14351-1);
- ◆ Description of the product: generic name, material, size, etc. and intended use; Information about the essential characteristics that must be declared: Declared values or levels and/or classes;
- ◆ NPD - " No Performance Determined" for characteristics when relevant.



Il simbolo della marcatura CE e le informazioni di accompagnamento devono essere apposti in modo visibile, leggibile e indelebile in una o più delle posizioni seguenti (gerarchia di preferenza del fabbricante):

**Qualsiasi parte idonea del prodotto stesso, purché sia assicurata la visibilità quando si aprono le ante; Su un'etichetta attaccata; Sul suo imballaggio; Sul documento commerciale di accompagnamento.**

#### DOCUMENTAZIONE TECNICA DI ACCOMPAGNAMENTO

Il fabbricante deve fornire informazioni su quanto segue:

- *Immagazzinaggio e movimentazione, se il fabbricante non è responsabile dell'installazione del prodotto;*
- *Requisiti e tecniche d'installazione (sul posto), se il fabbricante non è responsabile dell'installazione del prodotto (Guida UNCSAAL)*
- *Manutenzione e pulizia (Manuale Consorzio TWIN SYSTEMS)*
- *Istruzioni d'uso finali incluse le istruzioni per la sostituzione di componenti*
- *Istruzioni per l'uso in condizioni di sicurezza.*

**In Italia i requisiti obbligatori per la Marcatura CE sono:**

- *Permeabilità dell'aria*
- *Trasmittanza termica*
- *Proprietà radiative (Fattore solare g, Trasmissione luminosa (TV))*

**In Spagna e in Portogallo i requisiti obbligatori per la Marcatura CE sono:**

- *Permeabilità all'aria*
- *Tenuta all'acqua*
- *Resistenza al vento*
- *Trasmittanza termica*
- *Isolamento acustico*

*The CE marking and accompanying information must be affixed in a visible, legible and indelible way in one or more of the following positions (manufacturer's hierarchy of preference):*

*Any suitable part of the product itself, provided that visibility is ensured when opening the doors; On an attached label; On its packaging; On the accompanying commercial document.*

#### ACCOMPANYING TECHNICAL DOCUMENTATION

*The manufacturer will provide information about:*

- *Storage and handling, if the manufacturer is not responsible for the installation of the product*
- *Requirements and installation methods (on site), if the manufacturer is not responsible for the installation of the product (UNCSAAL Guide)*
- *Maintenance and cleaning (TWIN SYSTEMS Consortium Manual)*
- *Final instructions for use including instructions for replacing components; Instructions for safe use.*

***In Italy, the mandatory requirements for CE marking are:***

- *Air permeability*
- *Heat Transmittance*
- *Radiative properties (Solar factor g, Light transmission (TV)).*

***In Spain and Portugal the mandatory requirements for CE marking are :***

- *Air permeability*
- *Watertightnes*
- *Wind resistance*
- *Heat Transmittance*
- *Sound insulation*



## TRASMITTANZA TERMICA DEI SERRAMENTI

## HEAT TRANSMISSION OF WINDOWS

E' necessario sapere che le prescrizioni dettate dal decreto ministeriale cambiano in funzione della tipologia di intervento edilizio (nuova costruzione, ristrutturazione importante di primo oppure secondo livello, riqualificazione energetica) e si applicano ad edifici sia pubblici sia privati.

Per edifici di nuova costruzione si intendono quei fabbricati il cui titolo abilitativo sia stato richiesto dopo l'entrata in vigore del decreto.

Sono assimilati agli edifici di nuova costruzione gli edifici sottoposti a demolizione e ricostruzione, qualunque sia il titolo abilitativo necessario, e gli ampliamenti di edifici esistenti la cui nuova porzione abbia un volume lordo climatizzato superiore al 15% di quello esistente o comunque superiore a 500 m<sup>3</sup>.

Per interventi di ristrutturazione importante di primo livello si intendono quelli che interessano l'involucro edilizio con un'incidenza superiore al 50 per cento della superficie disperdente lorda complessiva dell'edificio, comprendendo anche la ristrutturazione dell'impianto termico per il servizio di climatizzazione invernale e/o estiva asservito all'intero edificio.

Per interventi di ristrutturazione importante di secondo livello si intendono quelli che interessano l'involucro edilizio con un incidenza superiore al 25 per cento della superficie disperdente lorda complessiva dell'edificio e possono interessare l'impianto termico per il servizio di climatizzazione invernale e/o estiva.

Negli interventi di riqualificazione energetica rientrano gli interventi non riconducibili agli interventi succitati e che hanno un impatto sulla prestazione energetica dell'edificio. Rientrano quindi anche:

- Le ristrutturazioni che interessano l'involucro edilizio con un incidenza inferiore o uguale al 25% della superficie disperdente lorda complessiva dell'edificio e/o consistono nella nuova installazione, nella ristrutturazione di un impianto termico asservito all'edificio o di altri interventi parziali, ivi compresa la sostituzione del generatore;

- Gli ampliamenti di edifici esistenti la cui nuova porzione abbia un volume lordo climatizzato inferiore o uguale al 15% di quello esistente o comunque inferiore a 500 m<sup>3</sup>.

Per gli edifici di nuova costruzione e per quelli sottoposti a ristrutturazioni di primo livello, non sono previsti specifici limiti di trasmittanza termica da rispettare per le chiusure trasparenti. Sussiste l'obbligo di rispettare limiti per quanto concerne altri parametri tecnici che connotano gli impianti, l'involucro edilizio e l'edificio nel loro complesso (per esempio coefficiente medio globale di scambio termico per trasmissione per unità di superficie disperdente HT<sup>\*</sup> - area solare equivalente estiva per unità di superficie utile Asol,est/Asup utile - indice di prestazione termica utile per riscaldamento EPH,nd - indice di prestazione termica utile per il raffrescamento EPC,nd - indice di prestazione energetica globale dell'edificio EPgl,tot, ecc.) contenuti nell'Allegato A del decreto

*Note that the requirements as of the ministerial decree depend on the type of construction (new construction, major first or second level renovation, energy upgrading) and apply to both public and private buildings.*

*New buildings are those whose building permit has been requested following the promulgation of the decree.*

*Buildings subject to demolition and reconstruction, irrespective of the type of building permit, and extensions to existing buildings whose new portion has a gross air-conditioned volume of more than 15% of the existing one or in any case more than 500 m<sup>3</sup> are considered new buildings.*

*Major first level renovations are those affecting the building shell with an impact of more than 50% of the building's total gross dispersant surface, also including the renovation of the heating system for the winter and/or summer air conditioning service of the entire building.*

*For major second-level renovation interventions, those that concern the building shell with an impact of more than 25 percent of the building's total gross dispersant surface and can regard the heating plant system for the winter and/or summer air conditioning service.*

*Energy upgrading works include activities that are not attributable to the aforementioned activities and that have an impact on the building's energy performance. The following are therefore also included:*

- Renovations that affect the building shell with an impact of less than or equal to 25% of the building's total gross dispersant surface and/or the new installation or upgrading of the building's heating plant or other partial works, including the replacement of the generator;
- Extensions of existing buildings whose new portion has a gross air-conditioned volume of less than or equal to 15% of the existing one or in any case less than 500 m<sup>3</sup>.

*For new buildings and buildings undergoing first level renovations, there are no specific heat transmission limits to be respected for transparent doors. There is an obligation to respect the limits of other technical parameters that characterise the plants, shell and building as a whole (for example, average overall heat exchange coefficient for transmission by dispersant surface unit HT<sup>\*</sup> - equivalent summer solar area per unit of surface area Asol,est/Asup - useful heat performance index for heating EPH,nd - heat performance index for cooling EPC,nd - overall energy performance index of the building EPgl,tot, etc.) contained in Annex A of the decree*



I limiti dell'Allegato A sul coefficiente medio globale di scambio termico per trasmissione per unità di superficie disperdente HT' sono da rispettare anche per gli interventi di ristrutturazione importante di secondo livello.

Nell'ambito degli interventi di ristrutturazione importante di secondo livello e degli interventi di riqualificazione energetica sono invece da rispettare i limiti riportati nell'Appendice B del decreto relativamente:

- Alla trasmittanza termica  $U_w$  dei serramenti (trasparenti, opachi) e dei cassonetti posti a delimitazione di ambienti climatizzati verso l'esterno oppure verso ambienti non climatizzati (cfr. tabella 1);
- Al fattore di trasmissione solare totale  $g_{gl+sh}$  dei serramenti vetrati in combinazione con schermature solari mobili posizionati sui fronti dell'edificio SUD, EST, OVEST, SUD-EST, SUD-OVEST (cfr. tabella 2).

The limits of Annex A on the overall average coefficient of heat exchange through transmission by unit of dispersant surface HT' must also be respected for major second-level renovations.

In the case of major second level renovations and energy upgrading works, the limits set out in Appendix B of the decree must be respected for:

- Heat transmission  $U_w$  of the windows (transparent, opaque) and shutter boxes positioned to delimit air-conditioned environments towards the outside or towards non-conditioned environments (see table 1);
- The total solar transmission factor  $g_{gl+sh}$  glazed windows in combination with mobile solar shields positioned on the SOUTH, EAST, WEST, SOUTH-EAST, SOUTH-WEST building façades (see table 2).

Tabella/Table 1

Valori limite della trasmittanza  $U_w$  dei serramenti (trasparenti, opachi) e dei cassonetti posti a delimitazione di ambienti climatizzati verso l'esterno oppure verso ambienti non climatizzati.

| ZONA CLIMATICA | $U_w$ [W/m <sup>2</sup> K] |          |
|----------------|----------------------------|----------|
|                | 2021                       | ECOBONUS |
| Zona A+B       | 3.00                       | 2.60     |
| Zona C         | 2.00                       | 1.75     |
| Zona D         | 1.80                       | 1.67     |
| Zona E         | 1.40                       | 1.30     |
| Zona F         | 1.00                       | 1.00     |

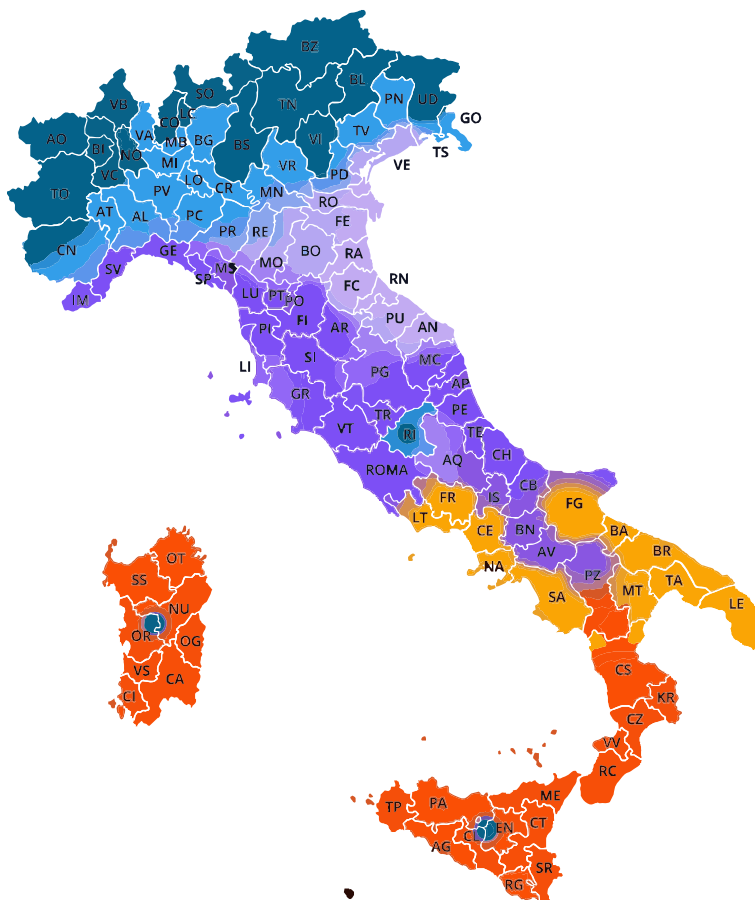

Tabella/Table 2

Valori limite del fattore di trasmissione solare totale  $g_{gl+sh}$  chiusure trasparenti in presenza di schermature solari mobili installate su fronti dell'edificio SUD, EST, OVEST, SUD-EST, SUD-OVEST

| ZONA CLIMATICA | $g_{gl+sh}$ |
|----------------|-------------|
|                | 2021        |
| Zone TUTTE     | 0.35        |



## VALUTAZIONE DELLA PRESTAZIONE TERMICA DEI SERRAMENTI

### TRASMITTANZA TERMICA:

La trasmittanza termica rappresenta il parametro più significativo per la valutazione del comportamento termico di un prodotto edilizio: minore è il suo valore migliore è la prestazione termica posseduta dal componente stesso.

**Il calcolo semplificato della trasmittanza termica del componente finestrato  $U_w$  composta da un singolo serramento e relativo vetro (o pannello) si esegue con la formula:**

## VALUTAZIONE DELLA PRESTAZIONE TERMICA DEI SERRAMENTI

### HEAT TRANSMISSION:

Heat transmission is the most significant factor in the evaluation of the thermal performance of a building product: the lower its value, the higher the thermal performance of the product.

*The simplified heat transmission calculation of the product glazing  $U_w$  comprising a single window and related glass (or panel) the formula is:*

$$U_w = \frac{A_g U_g + A_f U_f + l_g \emptyset_g}{A_g + A_f}$$

■  $A_g$ : Area del vetro in  $m^2$

■  $U_g$ : Trasmittanza termica riferito all'area centrale della vetrata, e non include l'effetto del distanziatore del vetro lungo il bordo della vetrata stessa

■  $A_f$ : Area del telaio

■  $U_f$ : Trasmittanza termica del telaio applicabile in assenza della vetrata

■  $l_g$ : Lunghezza del perimetro del vetro

■  $\emptyset_g$ : Trasmittanza termica lineare concernente la conduzione di calore supplementare che avviene a causa dell'interazione tra telaio, vetri e distanziatore dei vetri in funzione delle proprietà termiche di ognuno di questi componenti e si rileva, secondo quanto precisato nell'allegato E della norma UNI EN ISO 10077-1, preferibilmente con il calcolo numerico eseguito in accordo con la norma ISO 10077-2; quando non sono disponibili i risultati di calcolo dettagliati ci si può riferire ai prospetti E.1 ed E.2 i quali indicano i valori  $\emptyset_g$  di default per le tipiche combinazioni di telai, vetri e distanziatori.

■  $A_g$ : Area of the glass in  $m^2$

■  $U_g$ : Heat transmission of the central area of the window, not including the effect of the glass spacer along the edge of the window

■  $A_f$ : Frame area

■  $U_f$ : Heat transmission of the frame applicable in absence of the glass

■  $l_g$ : Length of the perimeter of the glass

■  $\emptyset_g$ : Linear heat transmission concerning the additional heat conduction that occurs due to the interaction between the frame, glass and spacer of the glass as a function of the thermal properties of each of these components and it is noted, as specified in Annex E of standard UNI EN ISO 10077-1, preferably with the numerical calculation performed in accordance with ISO 10077-2; when the detailed calculation results are not available you can refer to the default  $\emptyset_g$  for the typical combinations of frames, glass and spacers.



**ESTENDIBILITÀ**

L'appendice F della norma di prodotto UNI EN 14351-1 suggerisce le tipologie di serramento rappresentative e le relative estensioni, ma essendo la tabella puramente informativa, sta allo stesso produttore scegliere i campioni.

**EXTENSIBILITY**

Appendix F of the product standard UNI EN 14351-1 suggests the types of typical windows and their extensions, but since the table is purely informative, it is up to the manufacturer to choose the samples.

| <b>TIPO DI FINESTRA</b><br>WINDOW TYPE  | <b>POSSIBILE ESTENSIONE</b><br>Possible Extension                 |
|---|---|
| <b>Anta FISSA</b><br><i>Fixed</i>   | <b>Finestra Battente/Ribalta</b><br><i>Tilt &amp; Turn Window</i> |
| <b>Porta Finestra ad Anta Singola (Apertura Interna o Esterna)</b><br><i>Single door window (internal or external opening)</i>                      |   |
| <b>Finestra Anta Singola con Ribalta</b><br><i>Single Sash Tilt &amp; Turn Window</i>   |   |
| <b>Finestra con DUE o più Porte (Apertura Interna o Esterna)</b><br><i>Window with two or more doors (internal or external opening)</i>             | <b>Stessa Tipologia</b><br><i>Same Type</i>                       |
| <b>Finestra a UNA o DUE ante orizzontali scorrevoli</b><br><i>Window with ONE or TWO horizontal sliding sashes</i>                                  |   |
| <b>Finestra con DUE Ante Scorrevoli</b><br><i>Window with TWO Sliding Sashes</i>  | <b>Stessa Tipologia</b><br><i>Same Type</i>                       |
| <b>Finestra a UNA o DUE ante orizzontali scorrevoli con Ribalta</b><br><i>Window with ONE or TWO horizontal sliding sashes with Tilt &amp; Turn</i> | <b>Stessa Tipologia</b><br><i>Same Type</i>                       |
| <b>Bilico Orizzontale o Verticale</b><br><i>Horizontal or vertical pivoting window</i>  | <b>Stessa Tipologia</b><br><i>Same Type</i>                       |
| <b>Finestra a Soffietto</b><br><i>Folding Window</i>  | <b>Stessa Tipologia</b><br><i>Same Type</i>                       |

La norma UNI EN 14351-1 prevede che il calcolo effettuato su di un serramento aventi dimensioni:

**1230 (±25%) x 1480 (-25%)**  
**1480 (+25%) x 2180 (±25%)**

Le analisi termiche effettuate con le misure sopra descritte, possono essere estese a tutti i serramenti di tutte le dimensioni, purché il vetro utilizzato abbia come valore di  $U_g$  uguale o inferiore a 1.9 w/m<sup>2</sup>K, altrimenti la norma delle regole di estensione dei valori calcolati sull'infisso normalizzato ad infissi di diverse dimensioni.

Ovviamente i calcoli devono essere effettuati sulle stesse tipologie di infissi, e s'intende che una modifica del componente modifica la caratteristica in questione. In termini di prestazioni termiche è ovvio che andando a togliere o ad aggiungere elementi (per esempio passare da una finestra ad una anta, da una a due e così via), determina un variazione dei valori finali.

The UNI EN 14351-1 standard sets forth the calculation carried out on a window with dimensions:

**1230 (±25%) x 1480 (-25%)**  
**1480 (+25%) x 2180 (±25%)**

The thermal analyses carried out with the measurements described above can be extended to doors and windows of all sizes, provided that the glass used has a  $U_g$  value equal to or less than 1.9 w/m<sup>2</sup>K, otherwise the standard of the rules of the values calculated on the normalised frame is extended to frames of different sizes.

Obviously, the calculations must be carried out on the same types of frames, and it is understood that any modification to the component changes the characteristic in question. In terms of thermal performance, it is clear that, removing or adding elements (for example, switching from a window with one door to one with two doors, and so on) results in a change in the final values.



## POSA QUALITÀ

### IL MARCHIO

Il Marchio Posa Qualità Serramenti distinguerà i migliori costruttori italiani di serramenti di tutti i materiali, offrendo ai consumatori italiani uno strumento tangibile per distinguere le migliori aziende con una garanzia assicurativa post vendita sul prodotto installato fino a 10 anni.

In questo modo il costruttore di serramenti potrà qualificare al cliente non solo le prestazioni «astratte» di un serramento, bensì quelle reali, una volta installato, potrà attestare la qualificazione della propria Azienda e potrà garantire nel tempo ciò che ha venduto. Perché un Marchio rigoroso sulla Posa è l'unica forma di garanzia tangibile da offrire al consumatore.

Il progetto Marchi Posa Qualità prevede un piano di formazione che coinvolgerà tutta la filiera industriale del serramento, un Marchio che certificherà la qualità della progettazione della posa attraverso severi test di laboratorio e un Marchio che garantirà e verificherà la sua corretta esecuzione attraverso controlli a campione.

**il consorzio TWIN SYSTEMS è certificato PROGETTAZIONE Posa Qualità Serramenti dal 2020. I suoi consorziati organizzano periodicamente corsi professionali per l'acquisizione dei patentini professionali per i posatori.**



## POSA QUALITÀ

### THE TRADEMARK

The Posa Qualità Serramenti Trademark identifies the best Italian manufacturers of windows and doors in all materials, offering Italian consumers a tangible way of identifying the best companies with an after-sales warranty on the installed product of up to 10 years.

In this way, the window manufacturer will be able to offer the customer not only a guaranteed "generic" good performance of the window, but real guarantees and, once installed, it will be able to attest the quality of the company and guarantee the products sold over time. Because guaranteed good installation is the only way offering customers peace of mind.

The Posa Qualità Brands project includes a training plan that will involve the entire window supply chain, a Brand that will certify the quality of the installation by means of strict laboratory tests and guarantee correct installation through spot checks.

The TWIN SYSTEMS Consortium has been certified Posa Qualità Serramenti DESIGN since 2020. The consortium members organise periodic training courses for installers with the award of professional licenses.

## MANUALE e CATALOGO PRODOTTI TWIN SYSTEMS POSA QUALITÀ



**IL MANUALE e CATALOGO PRODOTTI TWIN SYSTEMS per la POSA QUALITÀ è**

- Disponibile presso le sedi dei consorziati e dei serramentisti di riferimento
- Liberamente scaricabile sul sito [www.twinsystems.it](http://www.twinsystems.it) nella sezione CATALOGHI

The TWIN SYSTEMS MANUAL and PRODUCT CATALOGUE for POSA QUALITÀ

- Is available from consortium members and reference window and door manufacturers
- Free download from the website [www.twinsystems.it](http://www.twinsystems.it) in the CATALOGUES section

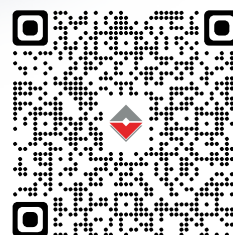

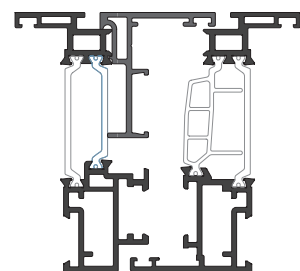
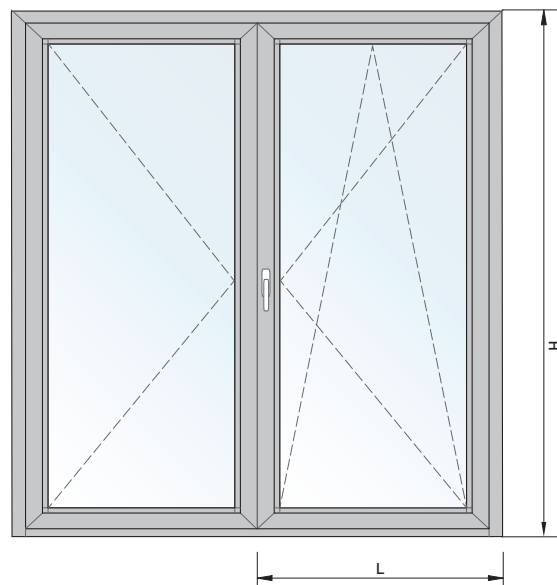
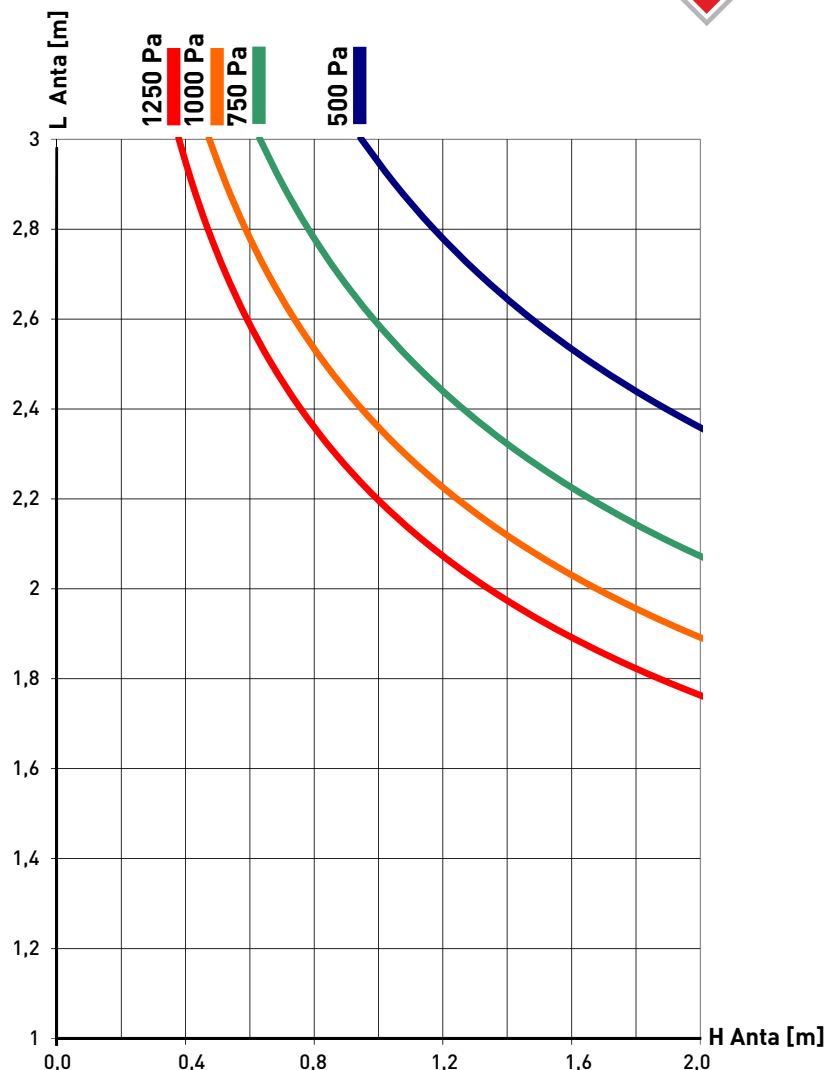

**MX753.305+304+235**

## Infisso a 2 ante. Deflessione del nodo centrale

Il dimensionamento risultante dal grafico è solo indicativo.

Il progettista o il serramentista, nel determinare le dimensioni massime dei serramenti, dovrà considerare e valutare, oltre le dimensioni ed il momento d'inerzia dei profilati, anche le caratteristiche applicative e meteorologiche quali l'altezza dal suolo, l'esposizione alla pioggia e la velocità dei venti nella zona.

Per questi dati consigliamo di consultare e seguire le "Raccomandazioni UNCSAAL" elaborate sulla base delle norme UNI, UNI-EN e UNI-CNR esistenti in merito.

Verificare che la freccia del profilato sia compatibile con quella del vetro utilizzato.

Le curve rappresentano la larghezza massima dell'anta in funzione della sua altezza e della pressione del vento.

Il serramento è considerato a 2 ante uguali.

Le curve sono calcolate sulla base della deformazione elastica di 1/300 dell'altezza del serramento.

## Double sash windows. Deflection of the central node

The dimensions resulting from the graph is only indicative.

In determining the maximum dimensions of the doors and windows, in addition to the dimensions and moment of inertia of the profiles, the designer or manufacturer must also consider and evaluate the application and meteorological conditions such as the height from the ground, exposure to rain and the speed of the winds in the area.

For these data, we recommend consulting and following the "UNCSAAL Recommendations" drawn up on the basis of the relative UNI, UNI-EN and UNI-CNR standards.

Check that the arrow on the profile is compatible with the arrow on the glass used.

The curves represent the maximum width of the door as a function of its height and wind pressure.

The frame is considered to have 2 doors.

The curves are calculated on the basis of the elastic deformation of 1/300 of the height of the window.



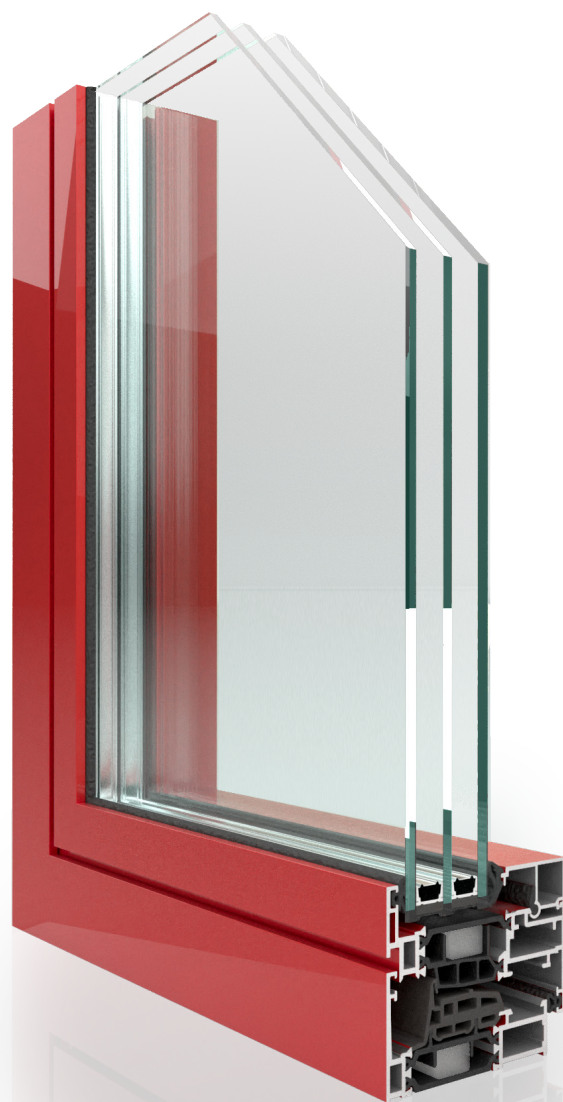

Profili  
*Profiles*

**Gruppo B**

Elenco Profili  
Profili Scala 1:1

*Profiles List*  
*Profiles Scale 1:1*







|  |                    |   |                           |
|--|--------------------|---|---------------------------|
| <b>MX603.607</b>   |                    |  | Tavola<br>Table<br><br>11 |
| Scivolo interno soglia bassa   |                    |   |                           |
| <i>Low Threshold Internal Slide</i>  |                    |   |                           |
| Peso   Weight  | kg/ml <b>0.149</b> |   |                           |
| J <sub>x</sub> 0 cm <sup>4</sup> W <sub>x</sub> 0 cm <sup>3</sup><br>J <sub>y</sub> 0 cm <sup>4</sup> W <sub>y</sub> 0 cm <sup>3</sup> |                    |   |                           |

|  |                    |   |                           |
|--|--------------------|---|---------------------------|
| <b>CX70.605</b>  |                    |  | Tavola<br>Table<br><br>11 |
| Astina   |                    |   |                           |
| <i>Bar</i>   |                    |   |                           |
| Peso   Weight  | kg/ml <b>0.146</b> |   |                           |
| J <sub>x</sub> 0 cm <sup>4</sup> W <sub>x</sub> 0 cm <sup>3</sup><br>J <sub>y</sub> 0 cm <sup>4</sup> W <sub>y</sub> 0 cm <sup>3</sup> |                    |   |                           |

|  |                    |           |   |                           |
|--|--------------------|-----------|---|---------------------------|
| <b>CX70.562</b>  |                    | H. 22 mm. |  | Tavola<br>Table<br><br>11 |
| Fermavetro sicurezza mm 14   |                    |           |   |                           |
| <i>Safety glazing bead mm 14</i>   |                    |           |   |                           |
| Peso   Weight  | kg/ml <b>0.324</b> |           |   |                           |
| J <sub>x</sub> 0 cm <sup>4</sup> W <sub>x</sub> 0 cm <sup>3</sup><br>J <sub>y</sub> 0 cm <sup>4</sup> W <sub>y</sub> 0 cm <sup>3</sup> |                    |           |   |                           |

|  |                   |           |   |                           |
|--|-------------------|-----------|---|---------------------------|
| <b>CX70.563</b>  |                   | H. 22 mm. |  | Tavola<br>Table<br><br>11 |
| Fermavetro sicurezza mm 18   |                   |           |   |                           |
| <i>Safety glazing bead mm 18</i>   |                   |           |   |                           |
| Peso   Weight  | kg/ml <b>0.33</b> |           |   |                           |
| J <sub>x</sub> 0 cm <sup>4</sup> W <sub>x</sub> 0 cm <sup>3</sup><br>J <sub>y</sub> 0 cm <sup>4</sup> W <sub>y</sub> 0 cm <sup>3</sup> |                   |           |   |                           |

|  |                    |           |   |                           |
|--|--------------------|-----------|---|---------------------------|
| <b>CX70.564</b>  |                    | H. 22 mm. |  | Tavola<br>Table<br><br>11 |
| Fermavetro sicurezza mm 22   |                    |           |   |                           |
| <i>Safety glazing bead mm 22</i>   |                    |           |   |                           |
| Peso   Weight  | kg/ml <b>0.348</b> |           |   |                           |
| J <sub>x</sub> 0 cm <sup>4</sup> W <sub>x</sub> 0 cm <sup>3</sup><br>J <sub>y</sub> 0 cm <sup>4</sup> W <sub>y</sub> 0 cm <sup>3</sup> |                    |           |   |                           |

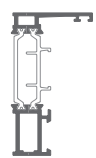
|  |                    |   |                          |
|--|--------------------|---|--------------------------|
| <b>MX753.101</b>   |                    |  | Tavola<br>Table<br><br>4 |
| Telaio a L piccolo   |                    |   |                          |
| <i>Small L frame</i>   |                    |   |                          |
| Peso   Weight  | kg/ml <b>1.100</b> |   |                          |
| J <sub>x</sub> 26.76cm <sup>4</sup> W <sub>x</sub> 6.79 cm <sup>3</sup><br>J <sub>y</sub> 3.12 cm <sup>4</sup> W <sub>y</sub> 1.07 cm <sup>3</sup> |                    |   |                          |

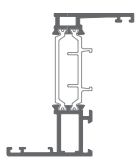
|  |                    |   |                          |
|--|--------------------|---|--------------------------|
| <b>MX753.102</b>   |                    |  | Tavola<br>Table<br><br>4 |
| Telaio a Z piccolo   |                    |   |                          |
| <i>Small Z frame</i>   |                    |   |                          |
| Peso   Weight  | kg/ml <b>1.255</b> |   |                          |
| J <sub>x</sub> 32.85cm <sup>4</sup> W <sub>x</sub> 7.76 cm <sup>3</sup><br>J <sub>y</sub> 6.63 cm <sup>4</sup> W <sub>y</sub> 1.95 cm <sup>3</sup> |                    |   |                          |

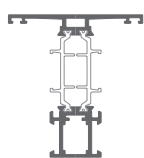
|  |                    |   |                          |
|--|--------------------|---|--------------------------|
| <b>MX753.103</b>   |                    |  | Tavola<br>Table<br><br>4 |
| Telaio/Traverso ad T piccolo   |                    |   |                          |
| <i>Small T frame/Crosspiece</i>  |                    |   |                          |
| Peso   Weight  | kg/ml <b>1.475</b> |   |                          |
| J <sub>x</sub> 37.15cm <sup>4</sup> W <sub>x</sub> 8.64 cm <sup>3</sup><br>J <sub>y</sub> 8.49 cm <sup>4</sup> W <sub>y</sub> 2.39 cm <sup>3</sup> |                    |   |                          |

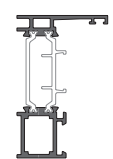
|  |                    |   |                          |
|--|--------------------|---|--------------------------|
| <b>MX753.104</b>   |                    |  | Tavola<br>Table<br><br>9 |
| Telaio a L intermedio FN   |                    |   |                          |
| <i>Medium L frame TH</i>   |                    |   |                          |
| Peso   Weight  | kg/ml <b>1.261</b> |   |                          |
| J <sub>x</sub> 32.85cm <sup>4</sup> W <sub>x</sub> 7.76 cm <sup>3</sup><br>J <sub>y</sub> 6.63 cm <sup>4</sup> W <sub>y</sub> 1.95 cm <sup>3</sup> |                    |   |                          |

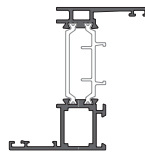
|  |                    |   |                          |
|--|--------------------|---|--------------------------|
| <b>MX753.105</b>   |                    |  | Tavola<br>Table<br><br>9 |
| Telaio a Z intermedio FN   |                    |   |                          |
| <i>Medium Z frame TH</i>   |                    |   |                          |
| Peso   Weight  | kg/ml <b>1.413</b> |   |                          |
| J <sub>x</sub> 37.15cm <sup>4</sup> W <sub>x</sub> 8.64 cm <sup>3</sup><br>J <sub>y</sub> 8.49 cm <sup>4</sup> W <sub>y</sub> 2.39 cm <sup>3</sup> |                    |   |                          |

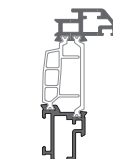
|  |                    |   |                          |
|--|--------------------|---|--------------------------|
| <b>MX753.201</b>   |                    |  | Tavola<br>Table<br><br>8 |
| Anta mobile smussata   |                    |   |                          |
| <i>Round Sash</i>  |                    |   |                          |
| Peso   Weight  | kg/ml <b>1.459</b> |   |                          |
| J <sub>x</sub> 45.82cm <sup>4</sup> W <sub>x</sub> 10.3 cm <sup>3</sup><br>J <sub>y</sub> 6.22 cm <sup>4</sup> W <sub>y</sub> 1.98 cm <sup>3</sup> |                    |   |                          |

|   |                    |   |                          |
|---|--------------------|---|--------------------------|
| <b>MX753.202</b>  |                    |  | Tavola<br>Table<br><br>7 |
| Anta mobile Effetto Ferro   |                    |   |                          |
| <i>Iron Style Sash</i>  |                    |   |                          |
| Peso   Weight   | kg/ml <b>1.460</b> |   |                          |
| J <sub>x</sub> 43.21cm <sup>4</sup> W <sub>x</sub> 9.44 cm <sup>3</sup><br>J <sub>y</sub> 5.18 cm <sup>4</sup> W <sub>y</sub> 1.7 cm <sup>3</sup> |                    |   |                          |

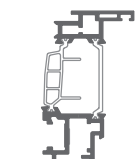
|  |                    |   |                          |
|--|--------------------|---|--------------------------|
| <b>MX753.204</b>   |                    |  | Tavola<br>Table<br><br>9 |
| Anta mobile FN   |                    |   |                          |
| <i>Sash for Tape Hardware</i>  |                    |   |                          |
| Peso   Weight  | kg/ml <b>1.743</b> |   |                          |
| J <sub>x</sub> 25.67cm <sup>4</sup> W <sub>x</sub> 6.71 cm <sup>3</sup><br>J <sub>y</sub> 4.48 cm <sup>4</sup> W <sub>y</sub> 1.59 cm <sup>3</sup> |                    |   |                          |

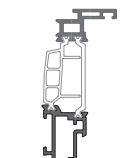
|  |                    |   |                          |
|--|--------------------|---|--------------------------|
| <b>MX753.235</b>   |                    |  | Tavola<br>Table<br><br>6 |
| Anta mobile  |                    |   |                          |
| <i>Sash</i>  |                    |   |                          |
| Peso   Weight  | kg/ml <b>1.384</b> |   |                          |
| J <sub>x</sub> 40.86cm <sup>4</sup> W <sub>x</sub> 8.49 cm <sup>3</sup><br>J <sub>y</sub> 4.91 cm <sup>4</sup> W <sub>y</sub> 1.64 cm <sup>3</sup> |                    |   |                          |

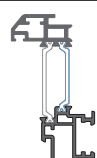
|  |                    |   |                          |
|--|--------------------|---|--------------------------|
| <b>MX753.301</b>   |                    |  | Tavola<br>Table<br><br>8 |
| Riporto anta mobile a smussata   |                    |   |                          |
| <i>Filler Profile for Round Sash</i>   |                    |   |                          |
| Peso   Weight  | kg/ml <b>1.359</b> |   |                          |
| J <sub>x</sub> 37.93cm <sup>4</sup> W <sub>x</sub> 8.93 cm <sup>3</sup><br>J <sub>y</sub> 54.54cm <sup>4</sup> W <sub>y</sub> 1.94 cm <sup>3</sup> |                    |   |                          |

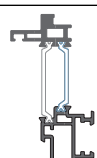
|  |                    |   |                          |
|--|--------------------|---|--------------------------|
| <b>MX753.302</b>   |                    |  | Tavola<br>Table<br><br>7 |
| Riporto anta mobile Effetto Ferro  |                    |   |                          |
| <i>Filler Profile for Round Sash Iron Style</i>  |                    |   |                          |
| Peso   Weight  | kg/ml <b>1.360</b> |   |                          |
| J <sub>x</sub> 37.23cm <sup>4</sup> W <sub>x</sub> 8.54 cm <sup>3</sup><br>J <sub>y</sub> 3.52 cm <sup>4</sup> W <sub>y</sub> 1.47 cm <sup>3</sup> |                    |   |                          |



|  |  |                   |   |  |                    |
|--|--|-------------------|---|--|--------------------|
| <p><b>MX753.304</b></p> <p>Profilo d Completamento 301/303<br/><i>Supplementary Profile 301/303</i></p> <p>Peso   Weight kg/ml <b>0.556</b></p> <p>J<sub>x</sub> 3.91 cm<sup>4</sup> W<sub>x</sub> 1.88 cm<sup>3</sup><br/>J<sub>y</sub> 1.41 cm<sup>4</sup> W<sub>y</sub> 0.75 cm<sup>3</sup></p> |  | Tavola Table<br>5 | <p><b>MX753.409</b></p> <p>Soglia<br/><i>Threshold</i></p> <p>Peso   Weight kg/ml <b>0.952</b></p> <p>J<sub>x</sub> 19.91 cm<sup>4</sup> W<sub>x</sub> 4.85 cm<sup>3</sup><br/>J<sub>y</sub> 6.35 cm<sup>4</sup> W<sub>y</sub> 0.39 cm<sup>3</sup></p>  |  | Tavola Table<br>4  |
| <p><b>MX753.305</b></p> <p>Riporto anta mobile dritta<br/><i>Filler Profile for Sash</i></p> <p>Peso   Weight kg/ml <b>1.284</b></p> <p>J<sub>x</sub> 35.39 cm<sup>4</sup> W<sub>x</sub> 3.45 cm<sup>3</sup><br/>J<sub>y</sub> 7.71 cm<sup>4</sup> W<sub>y</sub> 1.39 cm<sup>3</sup></p>           |  | Tavola Table<br>6 | <p><b>MX753.416</b></p> <p>Montante-Piastrino<br/><i>Uprigh-Plate</i></p> <p>Peso   Weight kg/ml <b>2.042</b></p> <p>J<sub>x</sub> 92.23 cm<sup>4</sup> W<sub>x</sub> 14.48 cm<sup>3</sup><br/>J<sub>y</sub> 8.73 cm<sup>4</sup> W<sub>y</sub> 2.45 cm<sup>3</sup></p>                        |  | Tavola Table<br>5  |
| <p><b>MX753.308</b></p> <p>Riporto Anta Mobile FN<br/><i>Filler Profile for Sash TH</i></p> <p>Peso   Weight kg/ml <b>1.615</b></p> <p>J<sub>x</sub> 30.88 cm<sup>4</sup> W<sub>x</sub> 8.32 cm<sup>3</sup><br/>J<sub>y</sub> 7.3 cm<sup>4</sup> W<sub>y</sub> 2.28 cm<sup>3</sup></p>             |  | Tavola Table<br>9 | <p><b>MX603.501</b></p> <p>Fermavetro diritto mm 13.6<br/><i>Square Glassholder 13.6 mm</i></p> <p>Peso   Weight kg/ml <b>0.216</b></p> <p>J<sub>x</sub> 25.95 cm<sup>4</sup> W<sub>x</sub> 7.64 cm<sup>3</sup><br/>J<sub>y</sub> 8.55 cm<sup>4</sup> W<sub>y</sub> 2.34 cm<sup>3</sup></p>   |  | Tavola Table<br>10 |
| <p><b>MX753.401</b></p> <p>Soprazoccolo Ante 201/202<br/><i>201/202 Sash Oversill</i></p> <p>Peso   Weight kg/ml <b>1.325</b></p> <p>J<sub>x</sub> 34.81 cm<sup>4</sup> W<sub>x</sub> 8.84 cm<sup>3</sup><br/>J<sub>y</sub> 6.22 cm<sup>4</sup> W<sub>y</sub> 2.21 cm<sup>3</sup></p>              |  | Tavola Table<br>7 | <p><b>MX603.502</b></p> <p>Fermavetro diritto mm 18.6<br/><i>Square Glassholder 18.6 mm</i></p> <p>Peso   Weight kg/ml <b>0.244</b></p> <p>J<sub>x</sub> 36.7 cm<sup>4</sup> W<sub>x</sub> 11.05 cm<sup>3</sup><br/>J<sub>y</sub> 28.12 cm<sup>4</sup> W<sub>y</sub> 5.78 cm<sup>3</sup></p>  |  | Tavola Table<br>10 |
| <p><b>MX753.402</b></p> <p>Traverso Ante 201/202<br/><i>235 Sash Crosspiece</i></p> <p>Peso   Weight kg/ml <b>1.232</b></p> <p>J<sub>x</sub> 32.7 cm<sup>4</sup> W<sub>x</sub> 7.52 cm<sup>3</sup><br/>J<sub>y</sub> 3.79 cm<sup>4</sup> W<sub>y</sub> 1.51 cm<sup>3</sup></p>                     |  | Tavola Table<br>8 | <p><b>MX603.503</b></p> <p>Fermavetro diritto mm 23.6<br/><i>Square Glassholder 23.6 mm</i></p> <p>Peso   Weight kg/ml <b>0.259</b></p> <p>J<sub>x</sub> 20.5 cm<sup>4</sup> W<sub>x</sub> 6.09 cm<sup>3</sup><br/>J<sub>y</sub> 4.75 cm<sup>4</sup> W<sub>y</sub> 1.47 cm<sup>3</sup></p>    |  | Tavola Table<br>10 |
| <p><b>MX753.403</b></p> <p>Traverso Anta 235<br/><i>201/202 Sash Crosspiece</i></p> <p>Peso   Weight kg/ml <b>1.383</b></p> <p>J<sub>x</sub> 43.26 cm<sup>4</sup> W<sub>x</sub> 8.64 cm<sup>3</sup><br/>J<sub>y</sub> 3.82 cm<sup>4</sup> W<sub>y</sub> 1.52 cm<sup>3</sup></p>                    |  | Tavola Table<br>6 | <p><b>MX603.504</b></p> <p>Fermavetro diritto mm 22.6<br/><i>Square Glassholder 22.6 mm</i></p> <p>Peso   Weight kg/ml <b>0.256</b></p> <p>J<sub>x</sub> 30.19 cm<sup>4</sup> W<sub>x</sub> 7.42 cm<sup>3</sup><br/>J<sub>y</sub> 6.82 cm<sup>4</sup> W<sub>y</sub> 2.14 cm<sup>3</sup></p>   |  | Tavola Table<br>10 |
| <p><b>MX753.404</b></p> <p>Soprazoccolo Ante 235<br/><i>235 Sash Oversill</i></p> <p>Peso   Weight kg/ml <b>1.475</b></p> <p>J<sub>x</sub> 46.29 cm<sup>4</sup> W<sub>x</sub> 10.88 cm<sup>3</sup><br/>J<sub>y</sub> 6.42 cm<sup>4</sup> W<sub>y</sub> 2.29 cm<sup>3</sup></p>                     |  | Tavola Table<br>6 | <p><b>MX603.505</b></p> <p>Fermavetro diritto mm 27.6<br/><i>Square Glassholder 27.6 mm</i></p> <p>Peso   Weight kg/ml <b>0.276</b></p> <p>J<sub>x</sub> 42.01 cm<sup>4</sup> W<sub>x</sub> 11.98 cm<sup>3</sup><br/>J<sub>y</sub> 15.78 cm<sup>4</sup> W<sub>y</sub> 4.61 cm<sup>3</sup></p> |  | Tavola Table<br>10 |
| <p><b>MX753.405</b></p> <p>Traverso Anta 202<br/><i>202 Sash Crosspiece</i></p> <p>Peso   Weight kg/ml <b>1.390</b></p> <p>J<sub>x</sub> 38.02 cm<sup>4</sup> W<sub>x</sub> 7.95 cm<sup>3</sup><br/>J<sub>y</sub> 3.67 cm<sup>4</sup> W<sub>y</sub> 1.46 cm<sup>3</sup></p>                        |  | Tavola Table<br>7 | <p><b>MX603.506</b></p> <p>Fermavetro diritto mm 32.6<br/><i>Square Glassholder 32.6 mm</i></p> <p>Peso   Weight kg/ml <b>0.297</b></p> <p>J<sub>x</sub> 31.02 cm<sup>4</sup> W<sub>x</sub> 8.16 cm<sup>3</sup><br/>J<sub>y</sub> 9.24 cm<sup>4</sup> W<sub>y</sub> 2.44 cm<sup>3</sup></p>   |  | Tavola Table<br>10 |





|  |   |  |                                  |
|--|---|--|----------------------------------|
| <b>MX603.507</b>   |   |  | Tavola<br>Table<br><br><b>10</b> |
| Fermavetro Effetto Ferro mm 18.6   |   |  |                                  |
| <i>Iron Style Glassholder 18.6 mm</i>                                    |   |  |                                  |
| Peso   Weight  | kg/ml <b>0.197</b>  |  |                                  |
| J <sub>x</sub> 27.78cm <sup>4</sup> W <sub>x</sub> 7.84 cm <sup>3</sup>  | J <sub>y</sub> 11.38cm <sup>4</sup> W <sub>y</sub> 2.58 cm <sup>3</sup> |  |                                  |
| <b>MX603.508</b>   |   |  | Tavola<br>Table<br><br><b>10</b> |
| Fermavetro Effetto Ferro mm 23.6   |   |  |                                  |
| <i>Iron Style Glassholder 23.6 mm</i>                                    |   |  |                                  |
| Peso   Weight  | kg/ml <b>0.216</b>  |  |                                  |
| J <sub>x</sub> 33.31cm <sup>4</sup> W <sub>x</sub> 8.72 cm <sup>3</sup>  | J <sub>y</sub> 9.92 cm <sup>4</sup> W <sub>y</sub> 2.82 cm <sup>3</sup> |  |                                  |
| <b>CX70.569</b>  |   |  | Tavola<br>Table<br><br><b>10</b> |
| Fermavetro Effetto Ferro mm 29.5   |   |  |                                  |
| <i>Iron Style Glassholder 29.6 mm</i>                                    |   |  |                                  |
| Peso   Weight  | kg/ml <b>0.262</b>  |  |                                  |
| J <sub>x</sub> 46.38cm <sup>4</sup> W <sub>x</sub> 12.27 cm <sup>3</sup> | J <sub>y</sub> 30.74cm <sup>4</sup> W <sub>y</sub> 6.49 cm <sup>3</sup> |  |                                  |
| <b>XX70.2040</b>   |   |  | Tavola<br>Table<br><br><b>11</b> |
| Gocciolatoio Mini  |   |  |                                  |
| <i>Mini Drip Tray</i>  |   |  |                                  |
| Peso   Weight  | kg/ml <b>0.095</b>  |  |                                  |
| J <sub>x</sub> - cm <sup>4</sup> W <sub>x</sub> - cm <sup>3</sup>        | J <sub>y</sub> - cm <sup>4</sup> W <sub>y</sub> - cm <sup>3</sup>       |  |                                  |
| <b>XX70.606</b>  |   |  | Tavola<br>Table<br><br><b>11</b> |
| Scivolo Esterno Soglia Bassa   |   |  |                                  |
| <i>Low Treshold External Slide</i>                                       |   |  |                                  |
| Peso   Weight  | kg/ml <b>0.322</b>  |  |                                  |
| J <sub>x</sub> - cm <sup>4</sup> W <sub>x</sub> - cm <sup>3</sup>        | J <sub>y</sub> - cm <sup>4</sup> W <sub>y</sub> - cm <sup>3</sup>       |  |                                  |
| <b>MX603.641</b>   |   |  | Tavola<br>Table<br><br><b>5</b>  |
| Cartella Centrale Simmetria  |   |  |                                  |
| <i>Central Carter for Symmetry</i>                                       |   |  |                                  |
| Peso   Weight  | kg/ml <b>0.496</b>  |  |                                  |
| J <sub>x</sub> - cm <sup>4</sup> W <sub>x</sub> - cm <sup>3</sup>        | J <sub>y</sub> - cm <sup>4</sup> W <sub>y</sub> - cm <sup>3</sup>       |  |                                  |

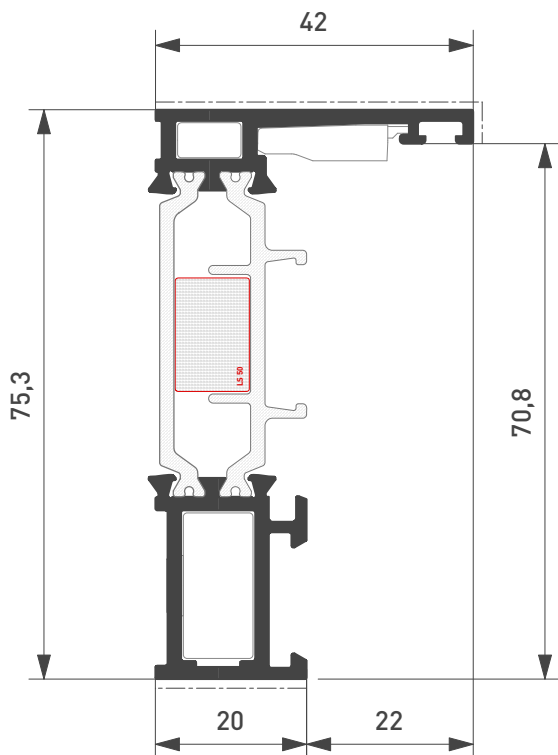

**MX753.101**

Kg/ml 1.100  
--- mm. 67,0

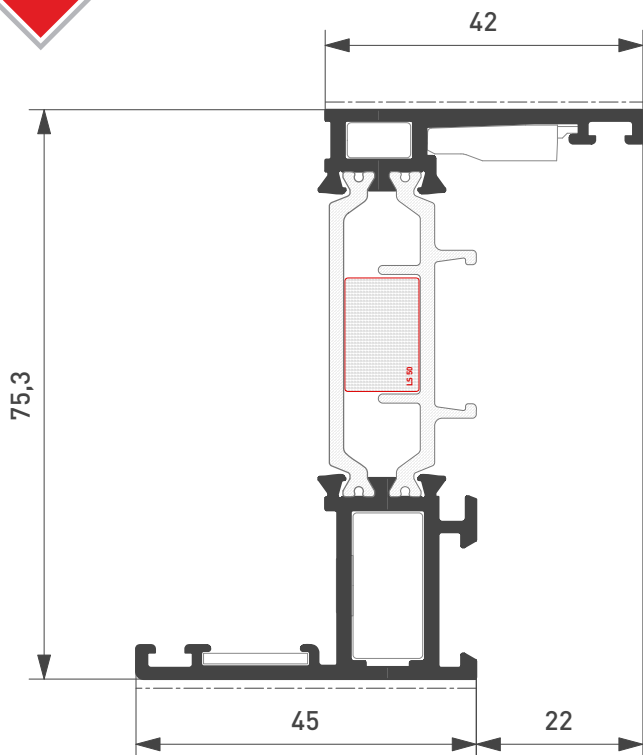

**MX753.102**

Kg/ml 1.255  
--- mm. 92,0

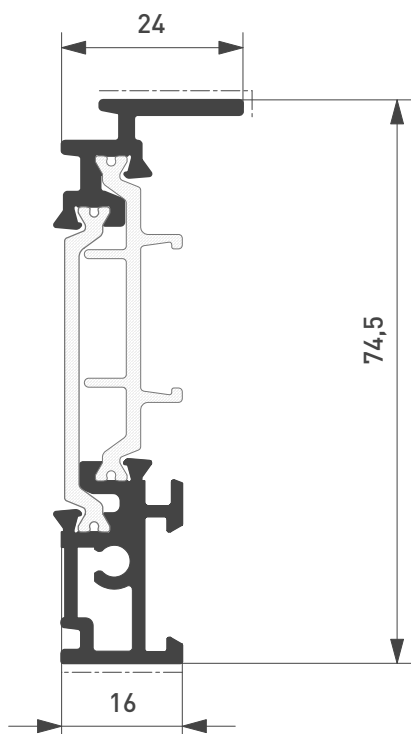

**MX753.409**

Kg/ml 0.952  
--- mm. 62,0

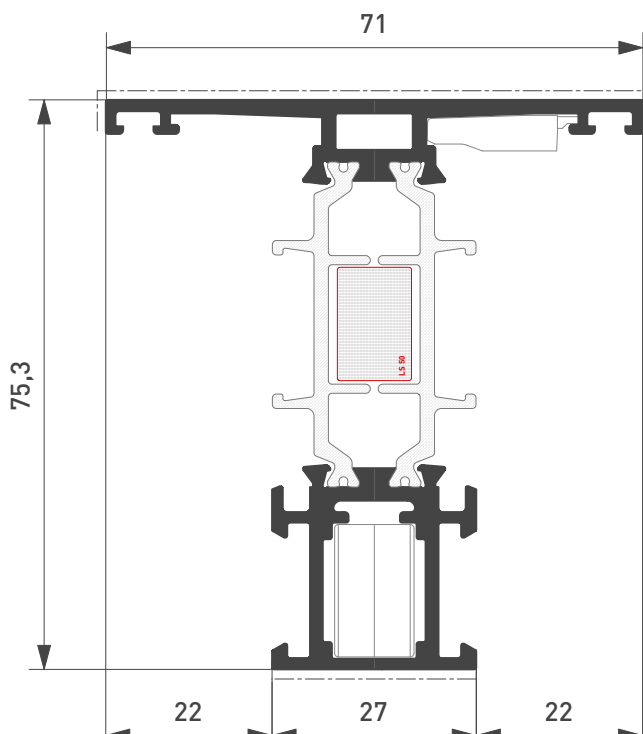

**MX753.103**

Kg/ml 1.475  
--- mm. 107,0

| Profilato<br>Profile | Squadretta esterna   External Corner Joint |                       |  |  | Squadretta Interna   Internal Corner Joint |                         |                       |                  |  | Sq. Allineamento   Alining Corner J. |                     |           |  |
|----------------------|--|-----------------------|--|--|--|-------------------------|-----------------------|------------------|--|--------------------------------------|---------------------|-----------|--|
|                      | Cianfrinare<br>Riveting                    | Spinare<br>Crimping   |  |  | Bottone<br>Slot                            | Cianfrinare<br>Riveting | Spinare<br>Crimping   | Awitare<br>Screw |  | Esterna<br>External                  | Interna<br>Internal |           |  |
| MX753.101            | ACX.49.SQ                                  | ACX.49.SQ + ARX.08.SQ |  |  | ACX.50.SQ                                  | ACX.51.SQ               | ACX.51.SQ + ACX.53.SQ |                  |  | ARX.15.SQ                            |                     |           |  |
| MX753.102            | ACX.49.SQ                                  | ACX.49.SQ + ARX.08.SQ |  |  | ACX.50.SQ                                  | ACX.51.SQ               | ACX.51.SQ + ACX.53.SQ |                  |  | ARX.15.SQ                            |                     | ARX.10.SQ |  |
|                      |  |                       |  |  |  |                         |                       |                  |  |                                      |                     |           |  |

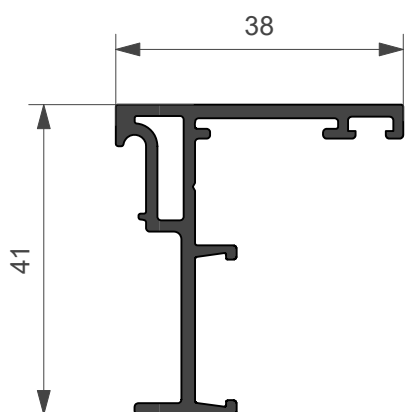

**MX753.304**

Kg/ml 0,556  
--- mm. 181,0

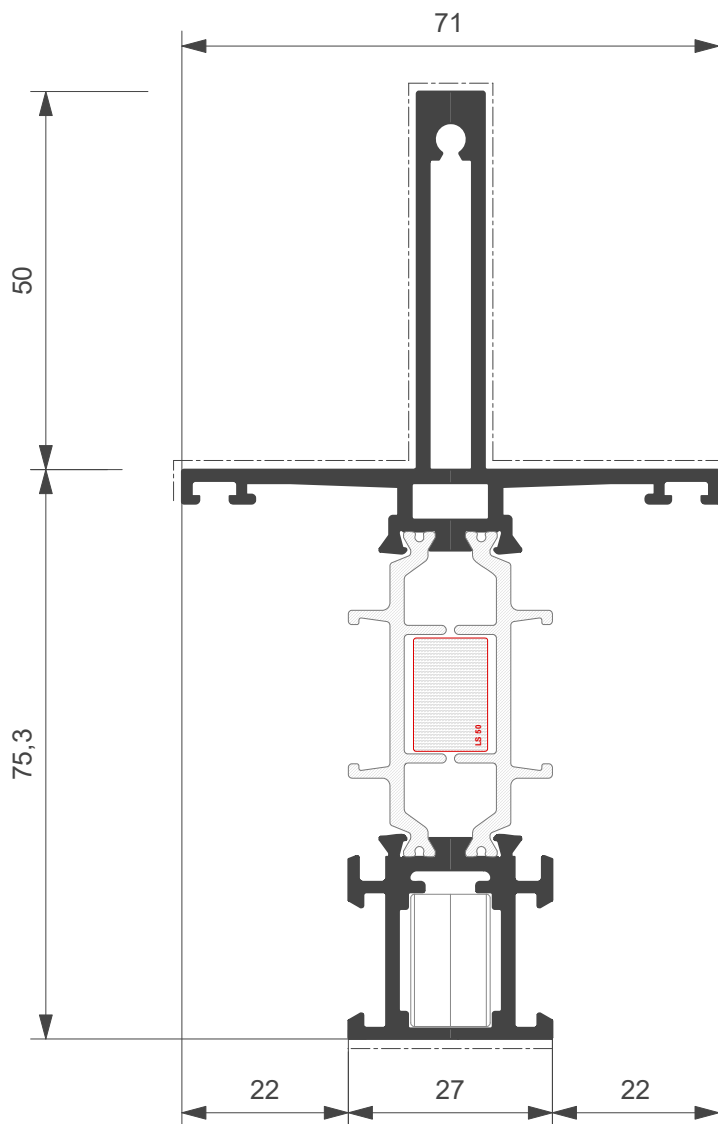

**MX753.416**

Kg/ml 2.042  
--- mm. 181,0

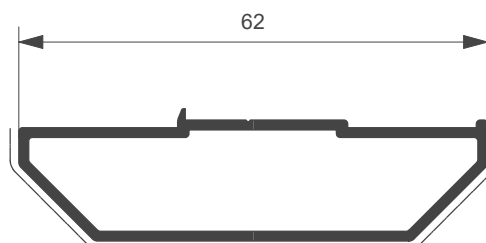

**MX603.641**

Kg/ml 0.496  
--- mm. 282,0

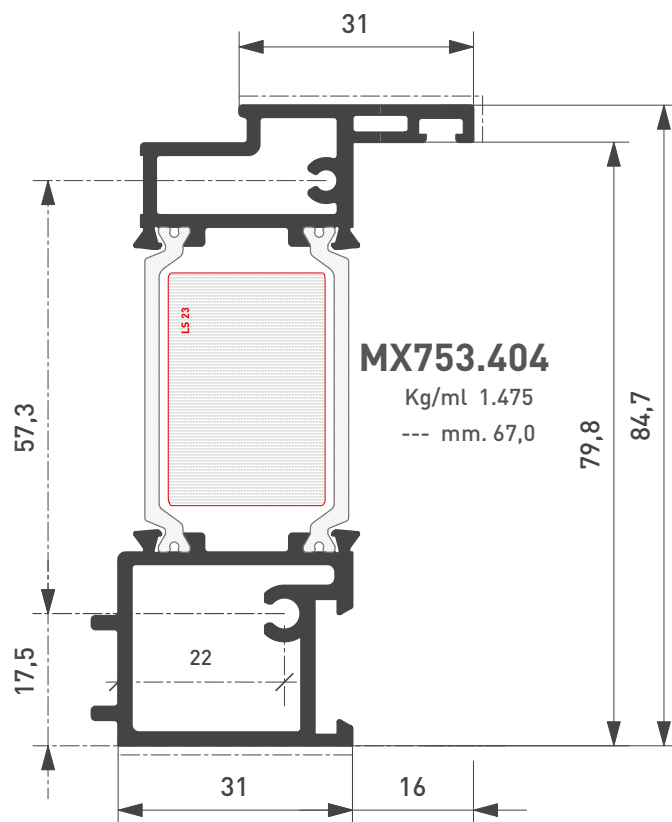
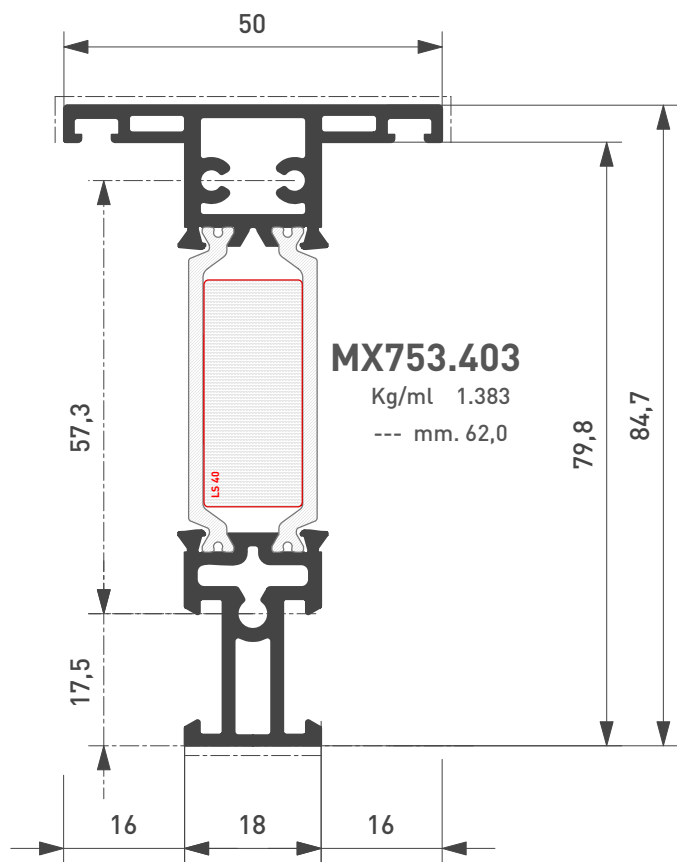
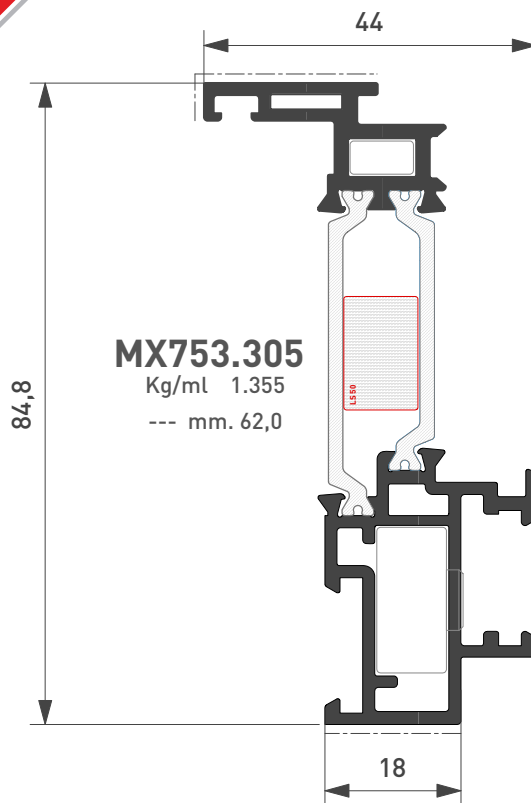
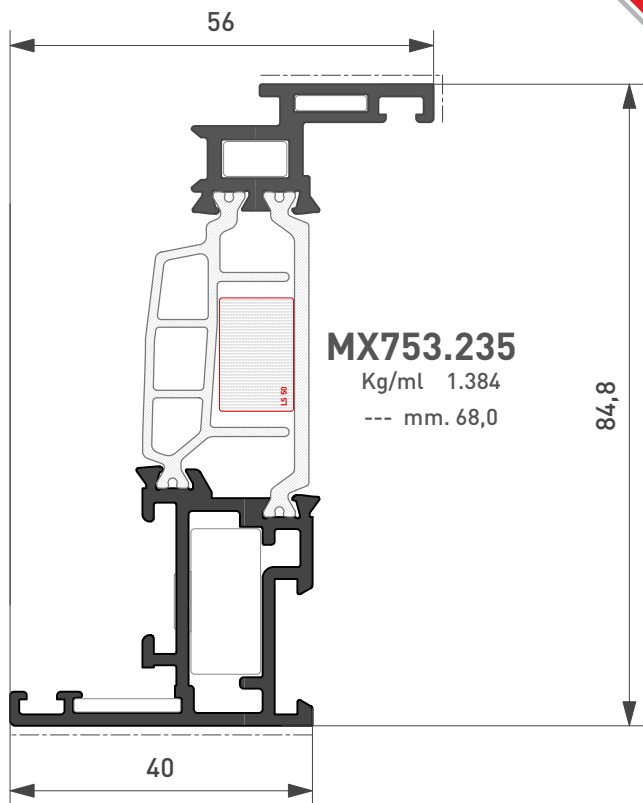

| Profilato<br>Profile | Squadretta esterna   External Corner Joint |                       | Squadretta Interna   Internal Corner Joint |                         |                     |                  | Sq. Allineamento   Alining Corner J. |                     |
|----------------------|--|-----------------------|--|-------------------------|---------------------|------------------|--------------------------------------|---------------------|
|                      | Cianfrinare<br>Riveting                    | Spinare<br>Crimping   | Bottone<br>Slot                            | Cianfrinare<br>Riveting | Spinare<br>Crimping | Awitare<br>Screw | Esterna<br>External                  | Interna<br>Internal |
| MX753.235            | ACX.49.SQ                                  | ACX.49.SQ + ARX.08.SQ | ACX.50.SQ                                  | ACX.51.SQ               | ACX.51.SQ           | + ACX.53.SQ      | ACX.54.SQ                            | ARX.10.SQ           |
| MX753.305            | ACX.49.SQ                                  |                       | ACX.50.SQ                                  | ACX.51.SQ               | ACX.51.SQ           | + ACX.53.SQ      | ACX.54.SQ                            |                     |
|                      |  |                       |  |                         |                     |                  |                                      |                     |

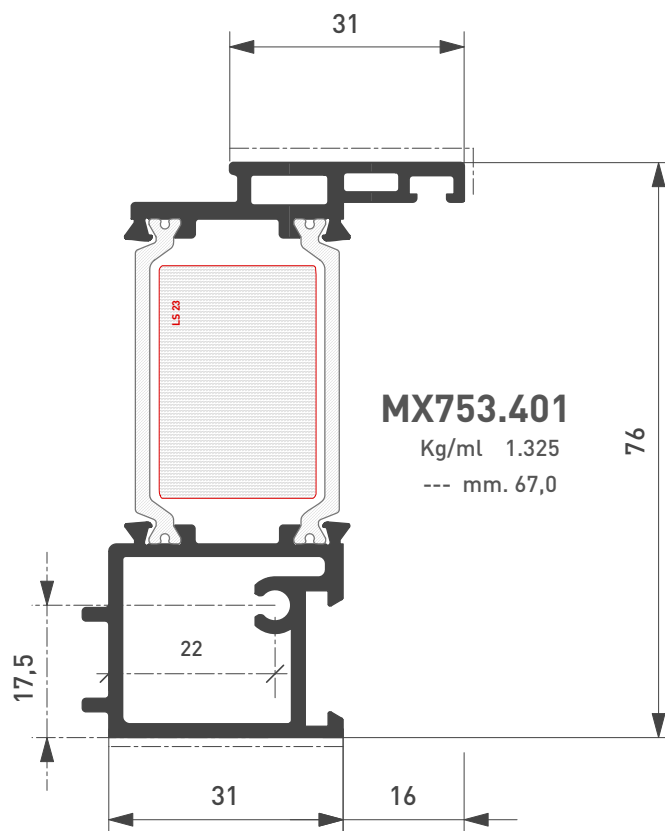
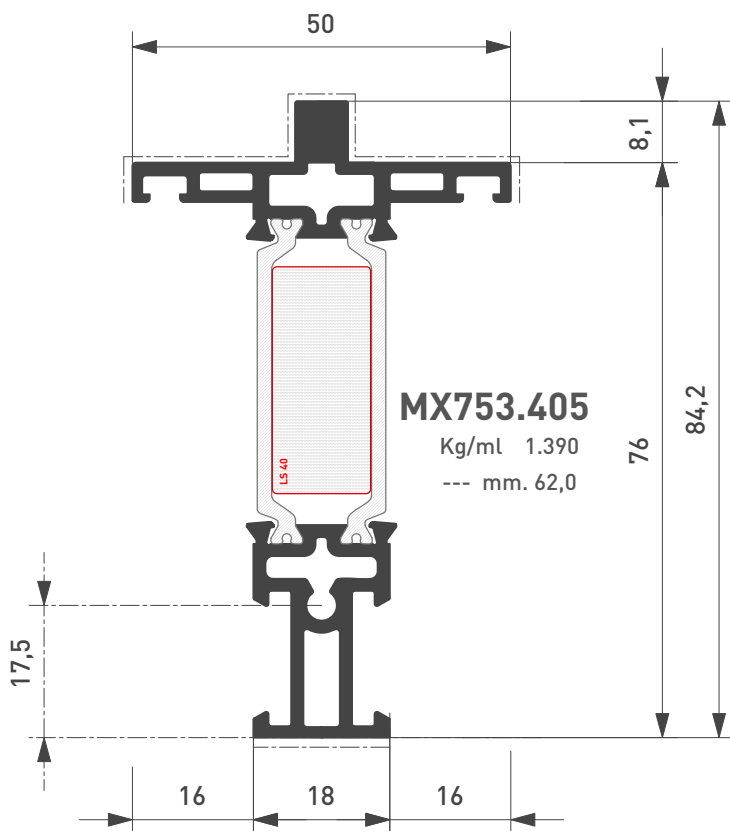
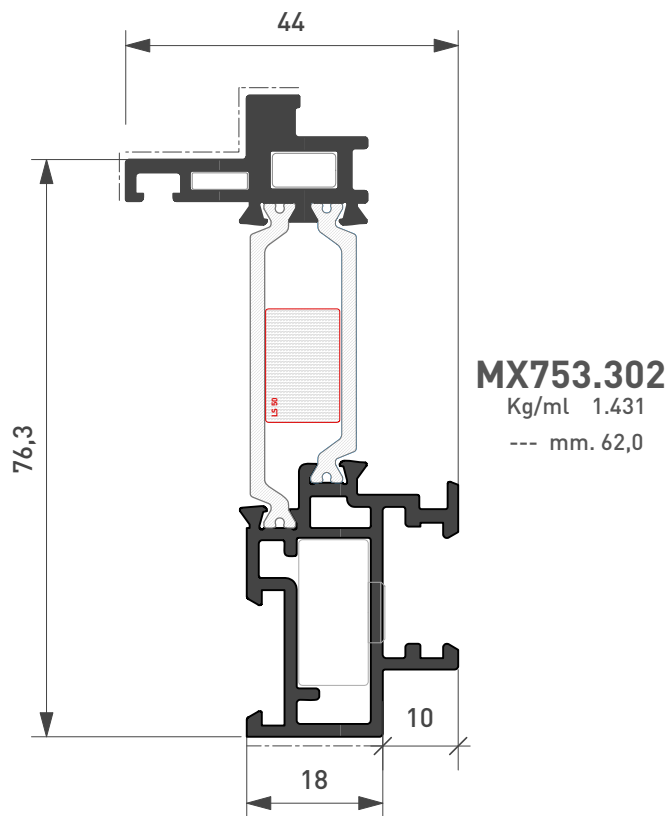
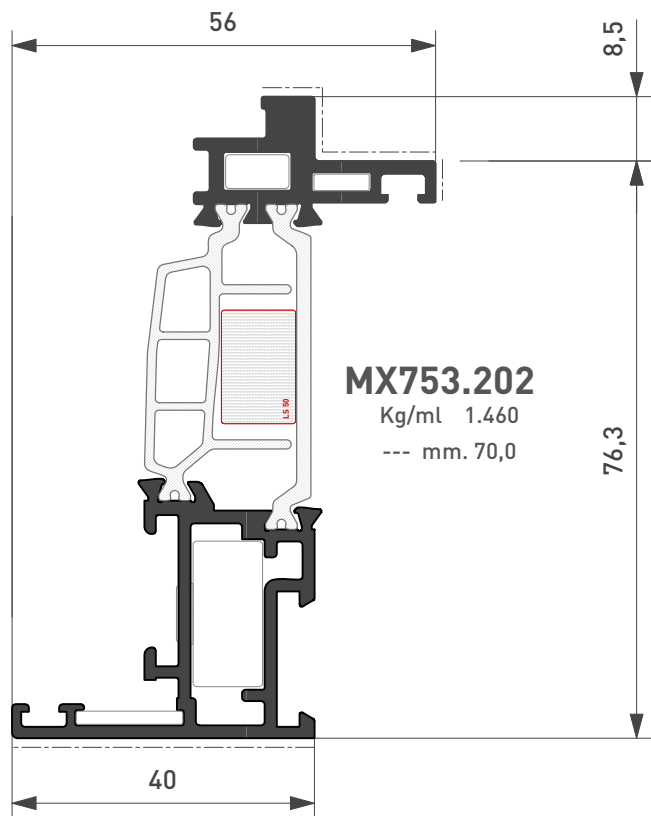

| Profilato<br>Profile | Squadretta esterna   External Corner Joint |                       | Squadretta Interna   Internal Corner Joint |                         |                       |                   | Sq. Allineamento   Alining Corner J. |                     |
|----------------------|--|-----------------------|--|-------------------------|-----------------------|-------------------|--------------------------------------|---------------------|
|                      | Cianfrinare<br>Riveting                    | Spinare<br>Crimping   | Bottone<br>Slot                            | Cianfrinare<br>Riveting | Spinare<br>Crimping   | Avvitare<br>Screw | Esterna<br>External                  | Interna<br>Internal |
| MX753.202            | ACX.49.SQ                                  | ACX.49.SQ + ARX.08.SQ | ACX.50.SQ                                  | ACX.51.SQ               | ACX.51.SQ + ACX.53.SQ |                   | ACX.55.SQ                            | ARX.10.SQ           |
| MX753.302            | ACX.49.SQ                                  | ACX.49.SQ + ARX.08.SQ | ACX.50.SQ                                  | ACX.51.SQ               | ACX.51.SQ + ACX.53.SQ |                   | ACX.55.SQ                            |                     |
|                      |  |                       |  |                         |                       |                   |                                      |                     |

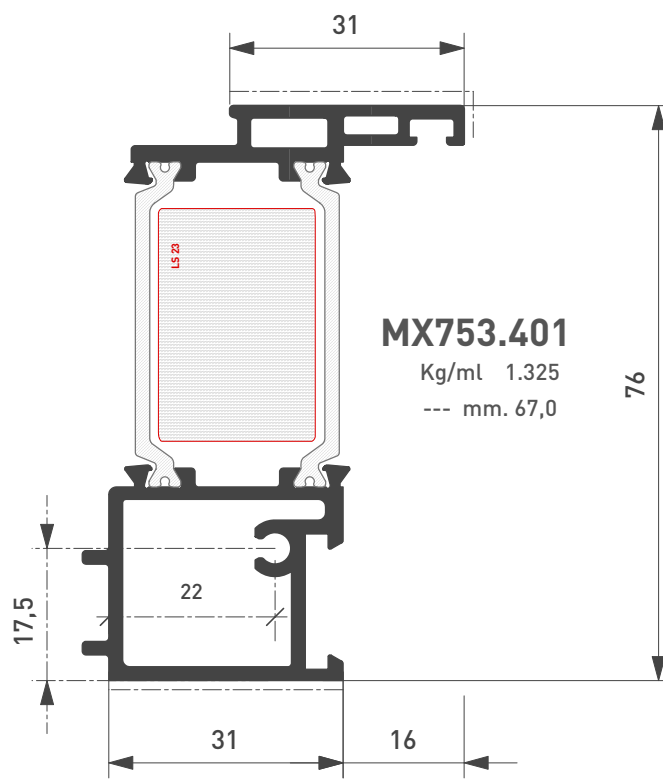
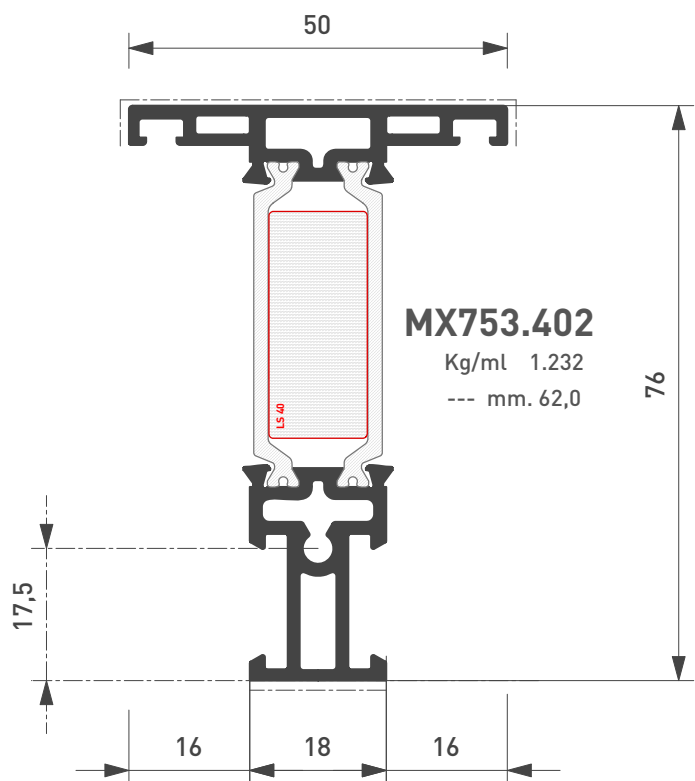
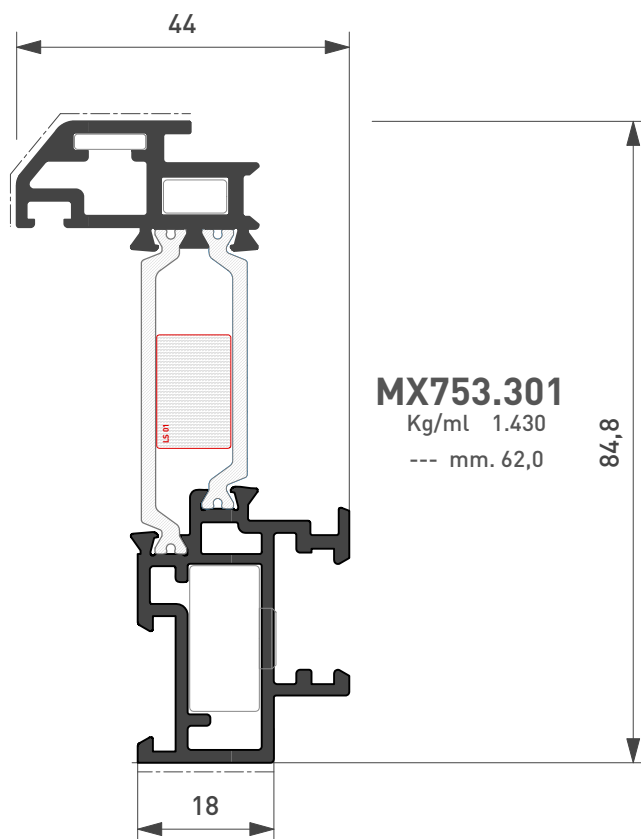
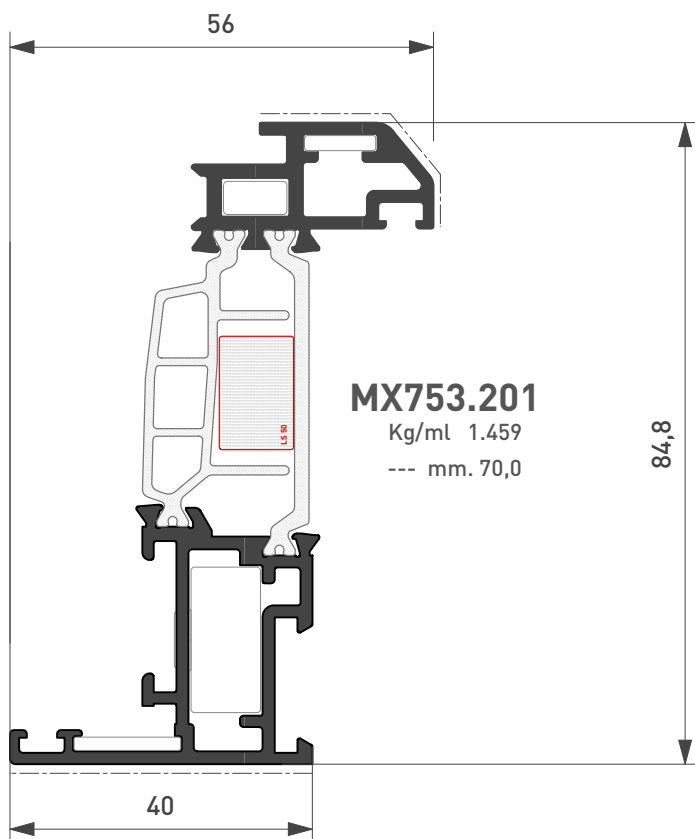

| Profilato<br>Profile | Squadretta esterna   External Corner Joint |                       |                 |                         | Squadretta Interna   Internal Corner Joint |                  |                     |                     |                     | Sq. Allineamento   Alining Corner J. |  |  |
|----------------------|--|-----------------------|-----------------|-------------------------|--|------------------|---------------------|---------------------|---------------------|--------------------------------------|--|--|
|                      | Cianfrinare<br>Riveting                    | Spinare<br>Crimping   | Bottone<br>Slot | Cianfrinare<br>Riveting | Spinare<br>Crimping                        | Awitare<br>Screw | Esterna<br>External | Interna<br>Internal | Esterna<br>External | Interna<br>Internal                  |  |  |
| MX753.201            | ACX.49.SQ                                  | ACX.49.SQ + ARX.08.SQ | ACX.50.SQ       | ACX.51.SQ               | ACX.51.SQ + ACX.53.SQ                      | ACX.54.SQ        | ARX.10.SQ           |                     |                     |                                      |  |  |
| MX753.301            | ACX.49.SQ                                  | ACX.49.SQ + ARX.08.SQ | ACX.50.SQ       | ACX.51.SQ               | ACX.51.SQ + ACX.53.SQ                      | ACX.54.SQ        |                     |                     |                     |                                      |  |  |
|                      |  |                       |                 |                         |  |                  |                     |                     |                     |                                      |  |  |



FERRAMENTA A NASTRO

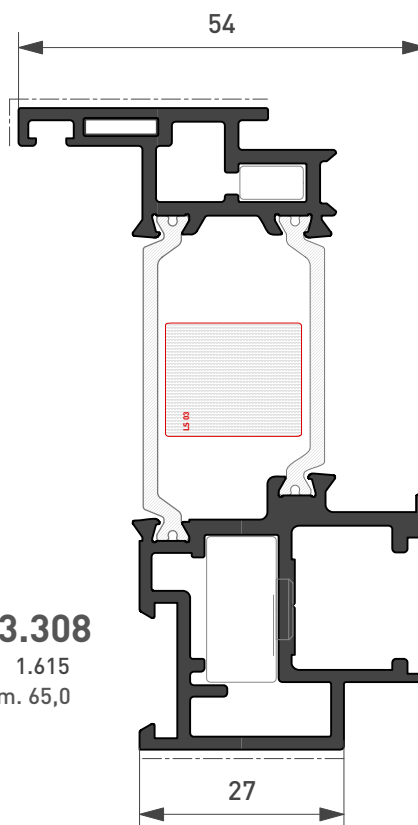
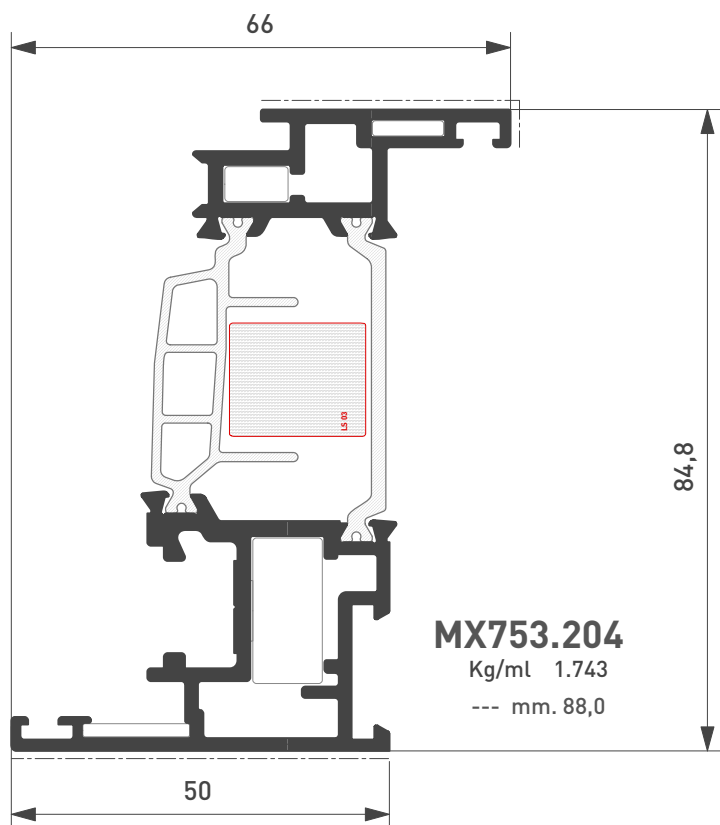
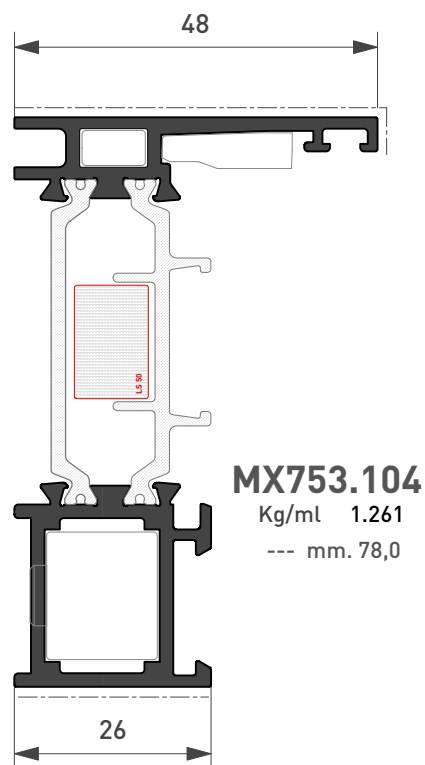
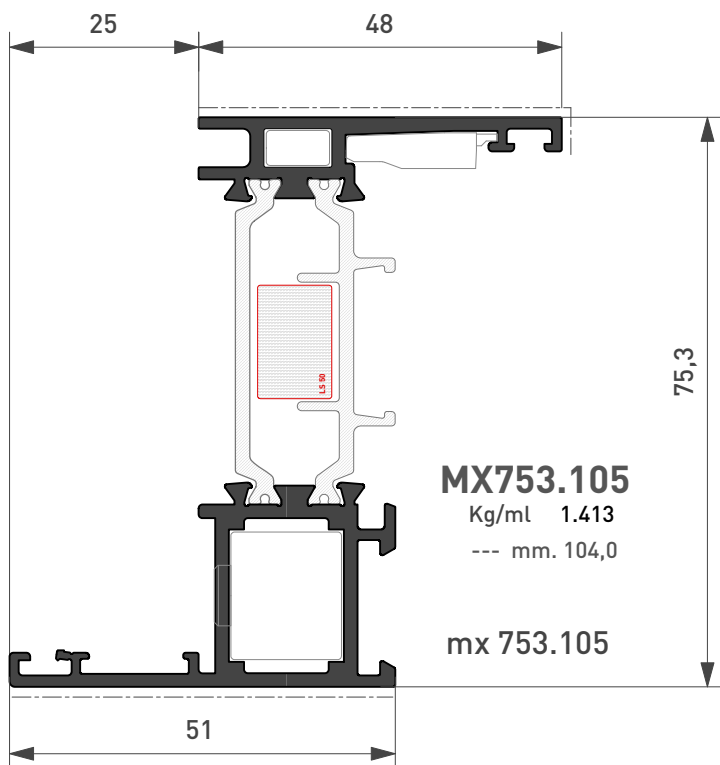

| Profilato<br>Profile | Squadretta esterna   External Corner Joint |                       | Squadretta Interna   Internal Corner Joint |                         |                       |                  | Sq. Allineamento   Alining Corner J. |                     |
|----------------------|--|-----------------------|--|-------------------------|-----------------------|------------------|--------------------------------------|---------------------|
|                      | Cianfrinare<br>Riveting                    | Spinare<br>Crimping   | Bottone<br>Slot                            | Cianfrinare<br>Riveting | Spinare<br>Crimping   | Awitare<br>Screw | Esterna<br>External                  | Interna<br>Internal |
| MX753.104            | ACX.49.SQ                                  | ACX.49.SQ + ARX.08.SQ | ACX.16.SQ                                  | AWX.19.SQ               | AWX.19.SQ + ARX.07.SQ |                  | ARX.15.SQ                            |                     |
| MX753.105            | ACX.49.SQ                                  | ACX.49.SQ + ARX.08.SQ | ACX.16.SQ                                  | AWX.19.SQ               | AWX.19.SQ + ARX.07.SQ |                  | ARX.15.SQ                            | ARX.10.SQ           |
| MX753.204            | ACX.49.SQ                                  | ACX.49.SQ + ARX.08.SQ | ACX.50.SQ                                  | ACX.51.SQ               | ACX.51.SQ + ACX.53.SQ |                  | ACX.54.SQ                            | ARX.10.SQ           |
| MX753.308            | ACX.49.SQ                                  | ACX.49.SQ + ARX.08.SQ | ACX.50.SQ                                  | ACX.51.SQ               | ACX.51.SQ + ACX.53.SQ |                  | ACX.54.SQ                            |                     |

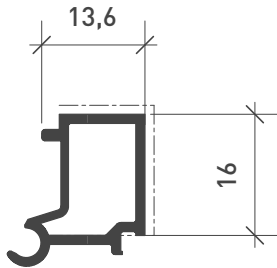

**MX603.501**  
Kg/ml 0.216  
--- mm. 29,6

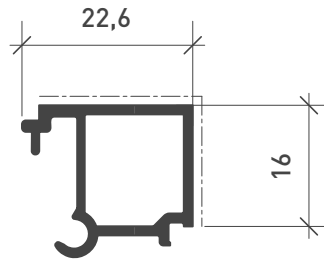

**MX603.504**  
Kg/ml 0.256  
--- mm. 38,6

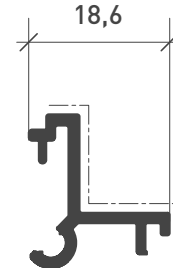

**MX603.507**  
Kg/ml 0.197  
--- mm. 34,6

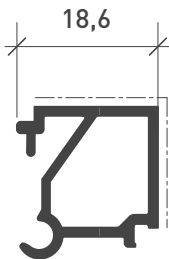

**MX603.502**  
Kg/ml 0.244  
--- mm. 34,6

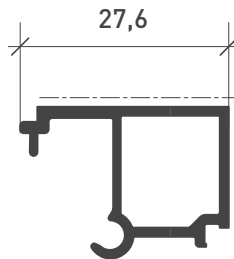

**MX603.505**  
Kg/ml 0.276  
--- mm. 43,6

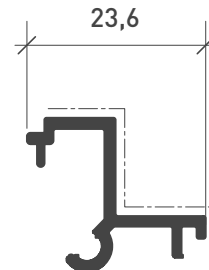

**MX603.508**  
Kg/ml 0.216  
--- mm. 39,6

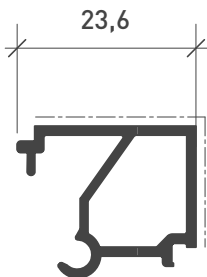

**MX603.503**  
Kg/ml 0.259  
--- mm. 39,6

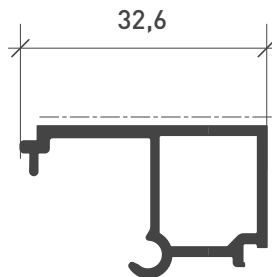

**MX603.506**  
Kg/ml 0.297  
--- mm. 48,6

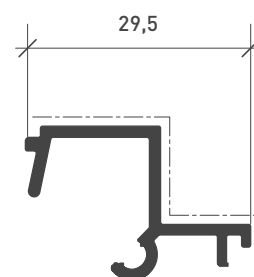

**CX70.569**  
Kg/ml 0.262  
--- mm. 45,5



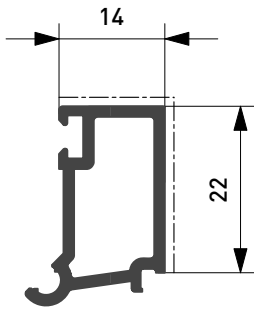

**CX70.562**

Kg/ml 0.324  
--- mm. 36,0

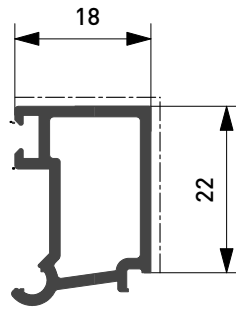

**CX70.563**

Kg/ml 0.330  
--- mm. 40,0

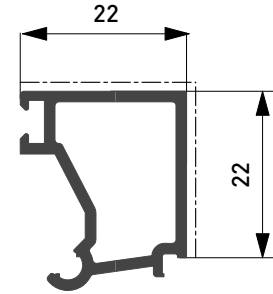

**CX70.564**

Kg/ml 0.348  
--- mm. 44,0

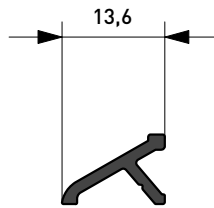

**XX70.2040**

Kg/ml 0,095  
--- mm. 14,0



**CX70.605**

Kg/ml 0,146  
--- mm. 14,0

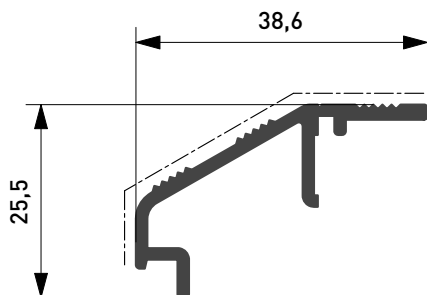

**XX70.606**

Kg/ml 0.322  
--- mm. 50,0

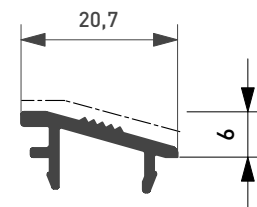

**MX603.607**

Kg/ml 0.149  
--- mm. 32,0



# TELAI FISSI

con fermavetri h=22 mm.

Guarnizione esterna vetro

Guarnizioni interne vetro

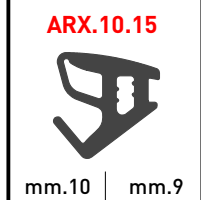
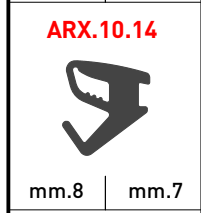
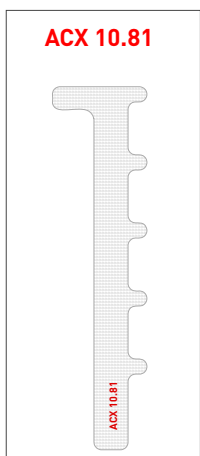
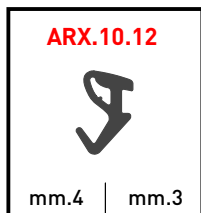

APPLICAZIONE TASSELLI VETRO PER TIPOLOGIA

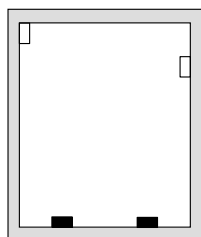

Telaio fisso

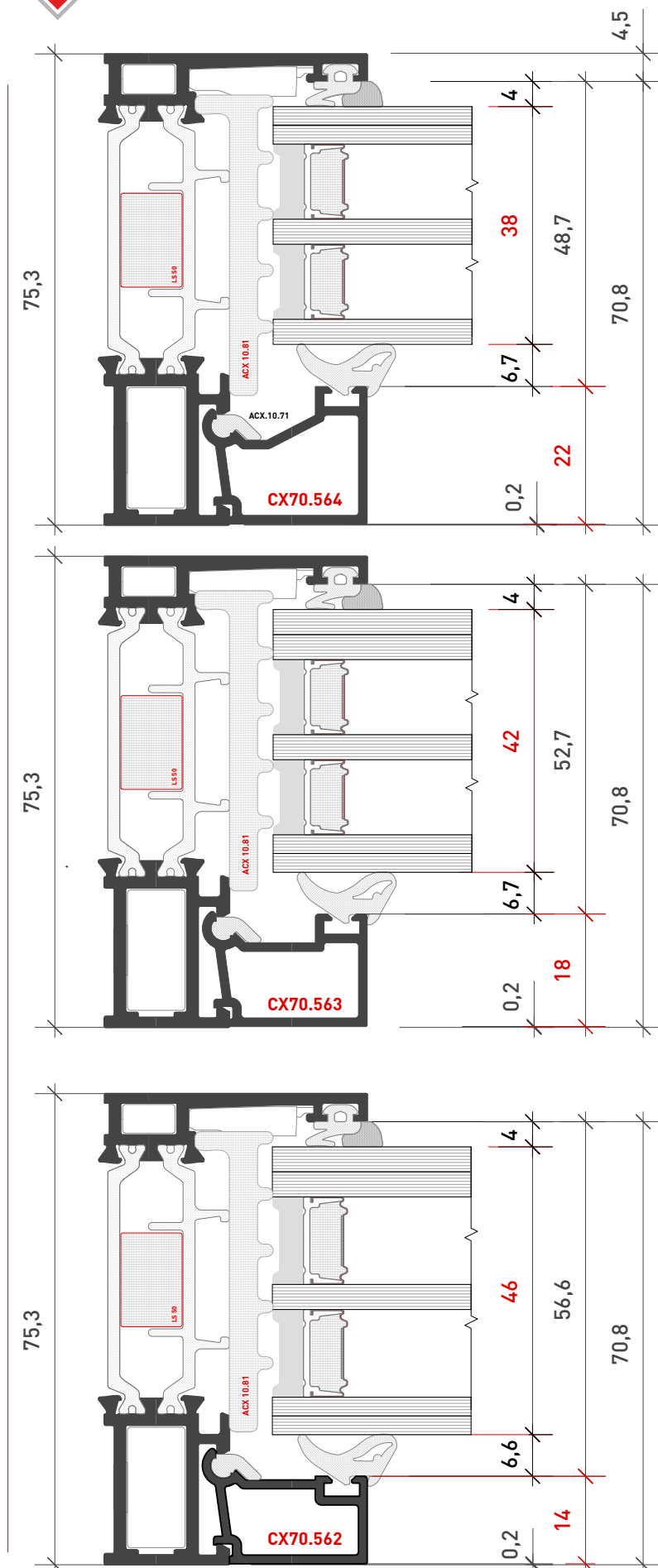

## TELAI FISSI

con fermavetri h=16 mm.

### Guarnizione esterna vetro

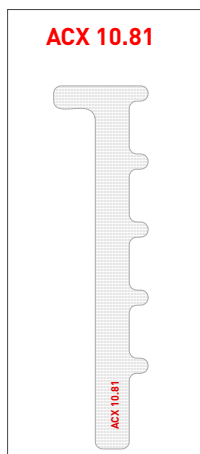
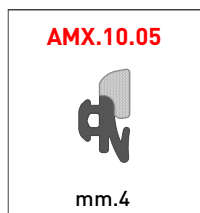

### Guarnizioni interne vetro

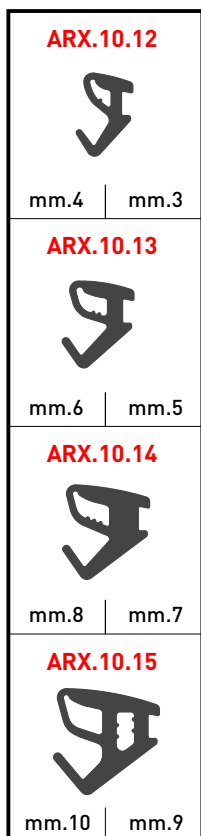

### APPLICAZIONE TASSELLI VETRO PER TIPOLOGIA

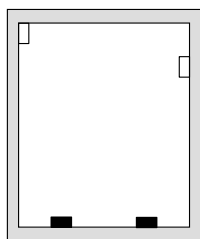

Telaio fisso

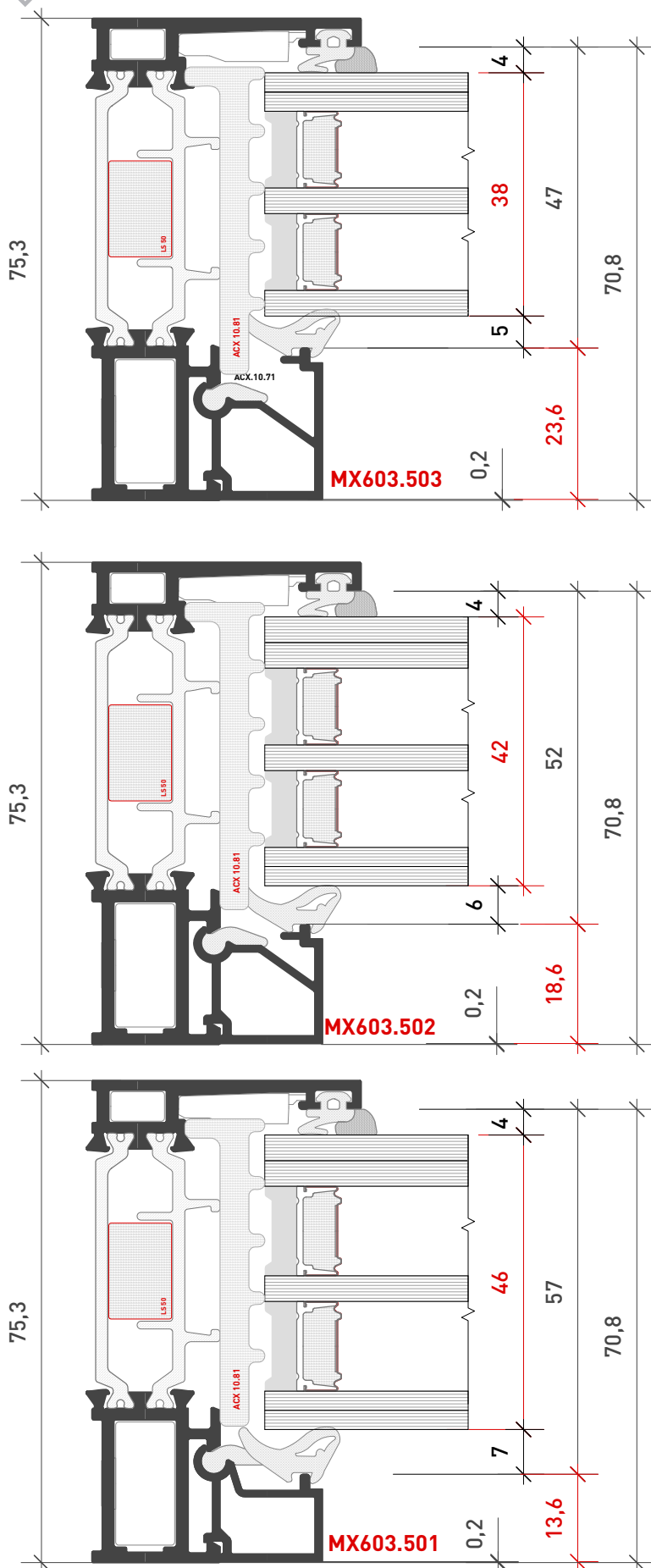



# ANTA MX753.235

## Guarnizione esterna vetro



## Guarnizioni interne vetro

|                                      |
|--------------------------------------|
| <b>ARX.10.12</b><br><br>mm.4   mm.3  |
| <b>ARX.10.13</b><br><br>mm.6   mm.5  |
| <b>ARX.10.14</b><br><br>mm.8   mm.7  |
| <b>ARX.10.15</b><br><br>mm.10   mm.9 |



## APPLICAZIONE TASSELLI VETRO PER TIPOLOGIA

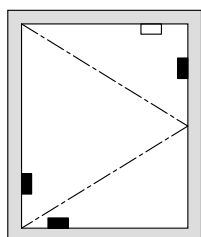

Anta a battente

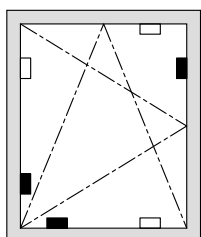

Anta ribalta

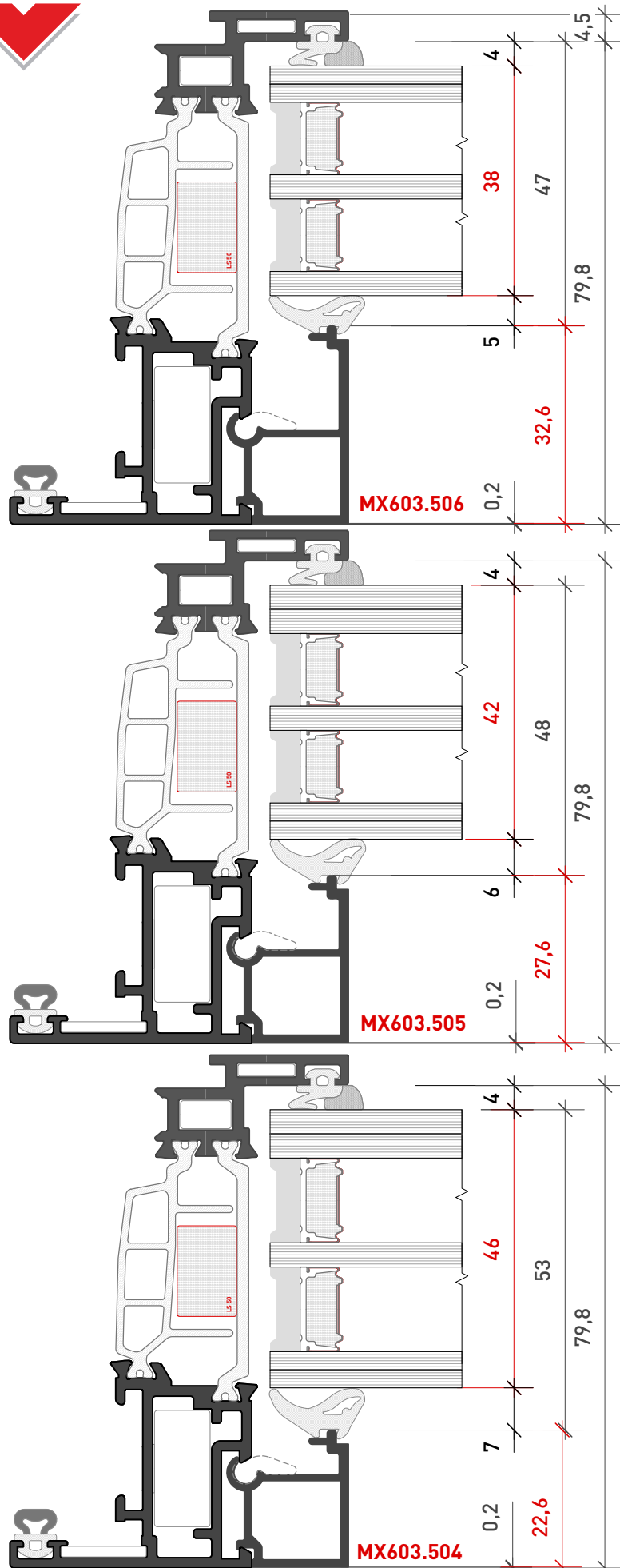



# ANTA MX753.202

## Guarnizione esterna vetro



## Guarnizioni interne vetro

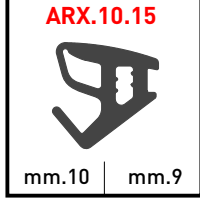
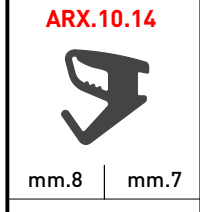
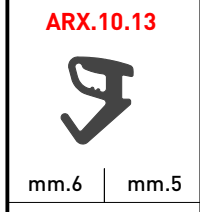
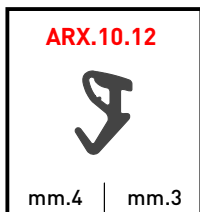

## APPLICAZIONE TASSELLI VETRO PER TIPOLOGIA

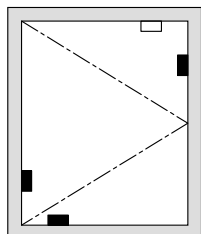

Anta a battente

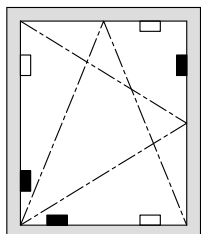

Anta ribalta

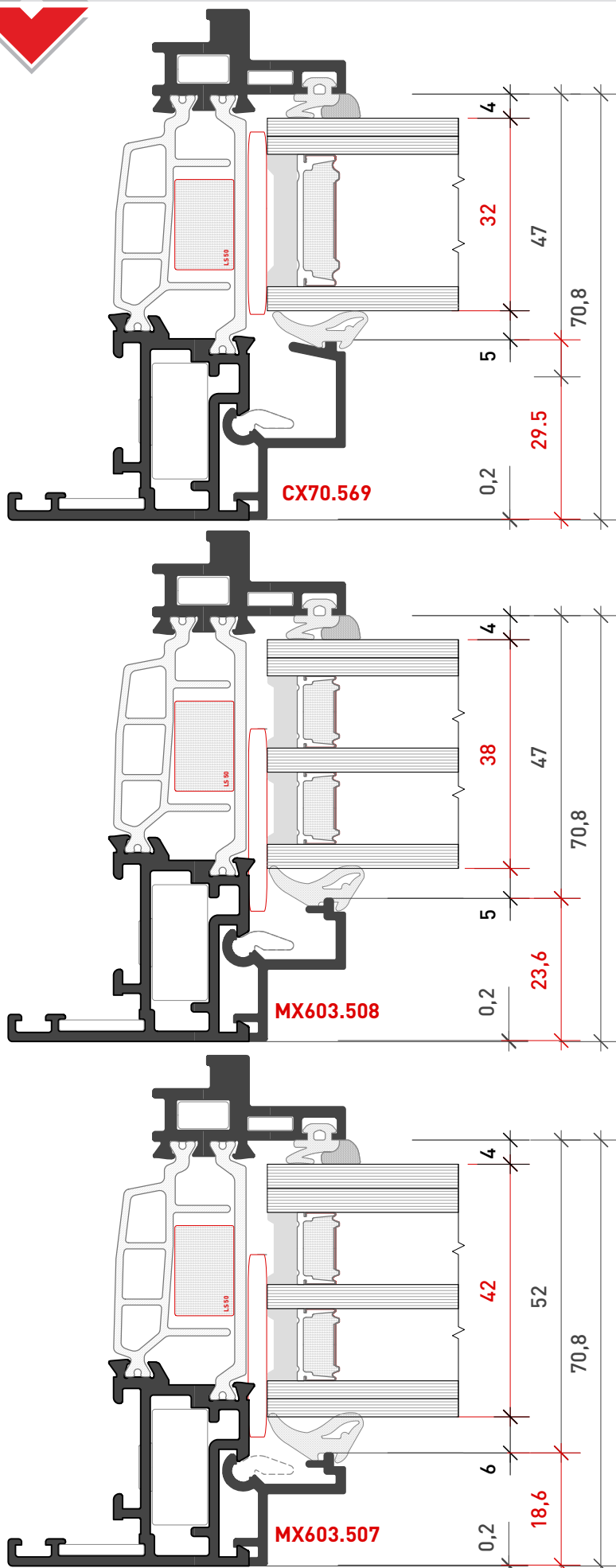



# ANTA MX753.201

## Guarnizione esterna vetro



## Guarnizioni interne vetro

|                                      |
|--------------------------------------|
| <b>ARX.10.12</b><br><br>mm.4   mm.3  |
| <b>ARX.10.13</b><br><br>mm.6   mm.5  |
| <b>ARX.10.14</b><br><br>mm.8   mm.7  |
| <b>ARX.10.15</b><br><br>mm.10   mm.9 |

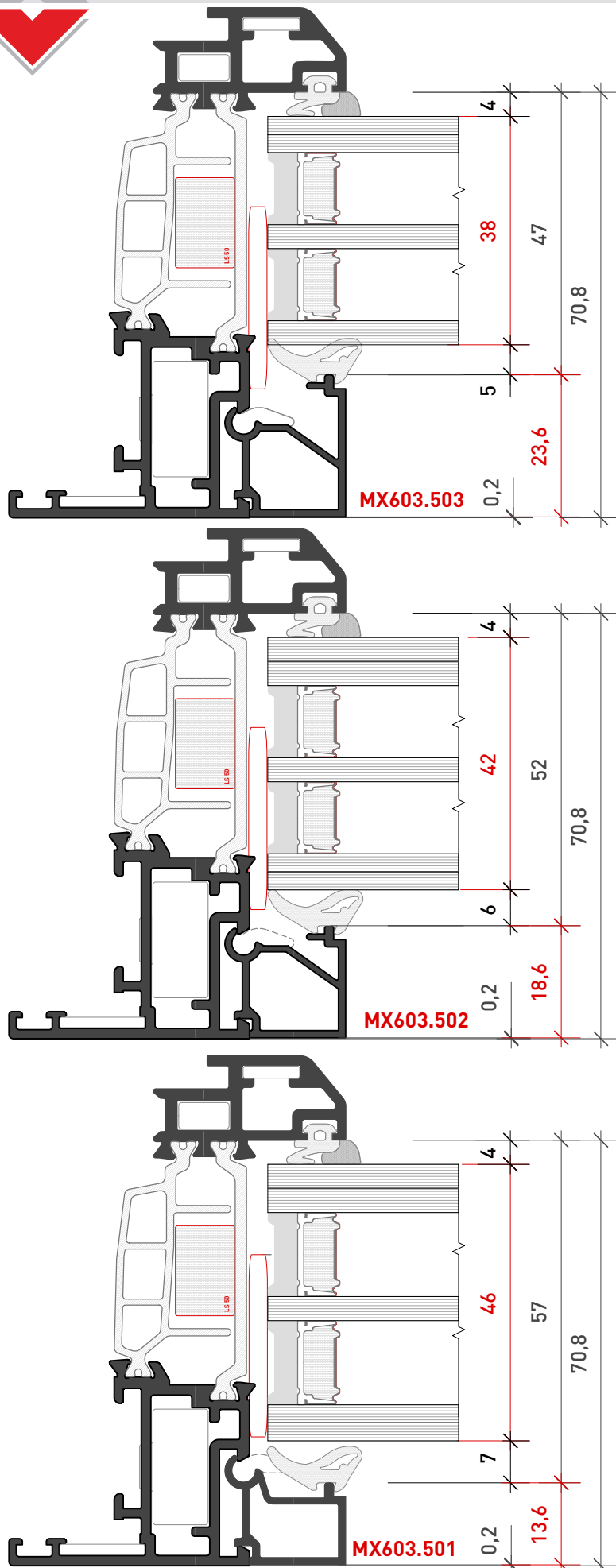

## APPLICAZIONE TASSELLI VETRO PER TIPOLOGIA

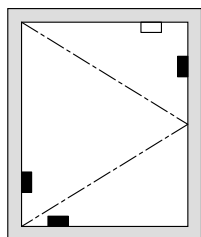

Anta a battente

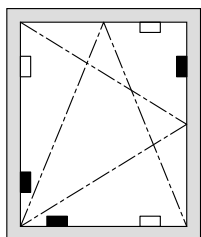

Anta ribalta

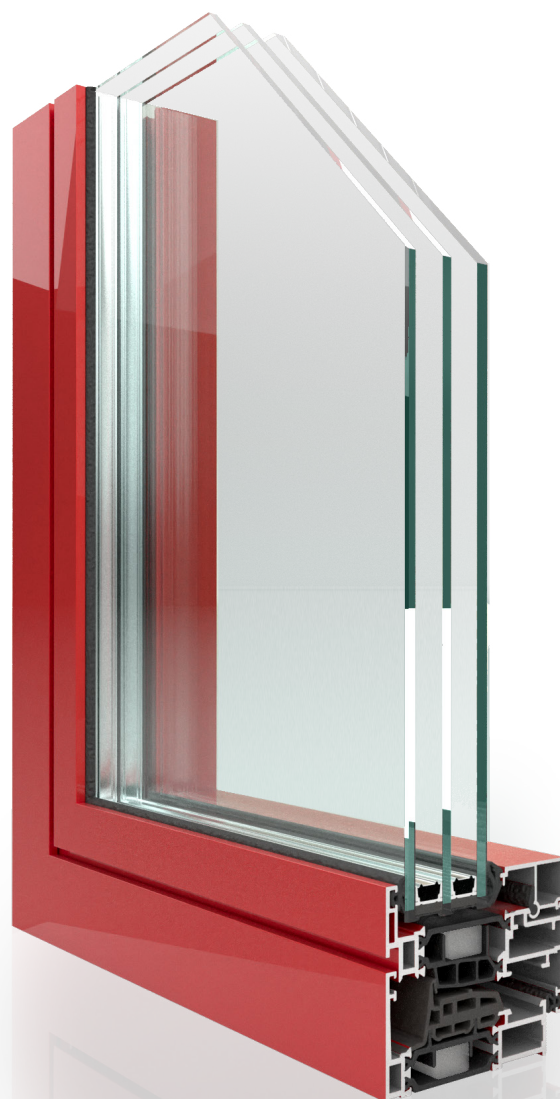

Accessori e Guarnizioni  
*Accessories and Gaskets*

Gruppo **C**

Elenco accessori | *List of Accessories*  
Elenco guarnizioni | *List of Window Gaskets*







## CODIFICA FINITURE SUPERFICIALI ACCESSORI

### ACCESSORIES SURFACE FINISHING CODES

In fase di ordine aggiungere agli accessori, se previste, le seguenti codifiche superficiali:  
When ordering, add the following surface codes to the accessories listed below, where applicable:

| <i>DESCRIPTION</i>                             | <b>CODICE<br/>CODE</b> | <b>DESCRIZIONE</b>         |
|--|------------------------|----------------------------|
| <i>PAINTED MATT BLACK</i>                      | <b>NEOPA</b>           | VERNICIATO NERO OPACO      |
| <i>WHITE</i>                                   | <b>R 9 0 1 0</b>       | VERNICIATO BIANCO          |
| <i>IVORY</i>                                   | <b>R 1 0 1 3</b>       | VERNICIATO AVORIO          |
| <i>GREEN</i>                                   | <b>R 6 0 0 5</b>       | VERNICIATO VERDE           |
| <i>BLACK</i>                                   | <b>R 9 0 0 5</b>       | VERNICIATO NERO LUCIDO     |
| <i>BROWN</i>                                   | <b>R 8 0 1 7</b>       | VERNICIATO MARRONE         |
| <i>GOTHIC GREEN</i>                            | <b>G 6 3 6 0</b>       | VERNICIATO VERDE GOTICO    |
| <i>GOTHIC GREY</i>                             | <b>G 9 4 2 0</b>       | VERNICIATO GRIGIO GOTICO   |
| <i>GOTHIC BROWN</i>                            | <b>G 3 9 7 6</b>       | VERNICIATO MARRONE GOTICO  |
| <i>SILVER</i>                                  | <b>V E A R</b>         | VERNICIATO ARGENTO         |
| <i>WITHERED MOSS</i>                           | <b>V S C R A</b>       | VERDE SCURO RAGGRINZITO    |
| <i>FALLOW</i>                                  | <b>M A R A G</b>       | MARRONE RAGGRINZITO        |
| <i>GOLDFINISH GUNMETAL GRAY</i>                | <b>K A N F U</b>       | CANNA DI FUCILE GOLDFINISH |
| <i>GOLDFINISH COPPER</i>                       | <b>K R A M E</b>       | RAME GOLDFINISH            |
| <i>GOLDFINISH POLISHED</i>                     | <b>K I N O X</b>       | INOX LUCIDO GOLDFINISH     |
| <i>GOLDFINISH SATIN-FINISH STAINLESS STEEL</i> | <b>K S A T I</b>       | INOX SATINATO GOLDFINISH   |
| <i>GOLDFINISH GOLD</i>                         | <b>K G O L D</b>       | GOLD GOLDFINISH            |
| <i>GOLDFINISH ANTIQUE BRASS</i>                | <b>K A N T I C</b>     | OTTONE ANTICO GOLDFINISH   |
| <i>NEW SILVER</i>                              | <b>A R G E N T</b>     | NEW ARGENTO                |
| <i>NEW BRONZE</i>                              | <b>B R O N Z</b>       | NEW BRONZO                 |















### ESEMPIO

**ADX** 02.40 | **R 9010**

EXAMPLE

**Cerniera Verniciata | COLORE Bianco Ral 9010**  
Painted Hinge | COLOUR White RAL 9010

**CERNIERE / HINGES**

|  |   |  |   |
|--|---|--|---|
| <p><b>ARX.08.SQ</b></p> <p>Descrizione   Description<br/>Spina Squad. ACX.49.SQ<br/>Plug for ACX.49.SQ<br/>su/on ACX.49.SQ</p>                             |    | <p><b>ACX.52.SQ</b></p> <p>Descrizione   Description<br/>Cavallotto per fissi<br/>T and CROSS Junctions<br/>17.5 x 10.5 mm</p>   |    |
| <p><b>ARX.10.SQ</b></p> <p>Descrizione   Description<br/>Squad. ALL INT<br/>INT Aligning Corner Joint</p>  |    | <p><b>ACX.53.SQ</b></p> <p>Descrizione   Description<br/>Spina inox Squad. ACX.51.SQ<br/>Spina Squad. ACX.51.SQ</p>  |    |
| <p><b>ARX.15.SQ</b></p> <p>Descrizione   Description<br/>Squad. ALL EXT tiraggio meccanico<br/>External aligning corner joint mechanical draught</p>       |    | <p><b>ACX.54.SQ</b></p> <p>Descrizione   Description<br/>Squad. ALL INOX MX603.201 - 235<br/>Aligning INOX Corner Joint MX603.201 - 235</p>  |    |
| <p><b>ARX.24.SQ</b></p> <p>Descrizione   Description<br/>Squad. ALL EXT<br/>External aligning corner joint<br/>17.5x15 mm.<br/>Pulsante/Button D= 8 mm</p> |    | <p><b>ACX.55.SQ</b></p> <p>Descrizione   Description<br/>Squad. ALL INOX MX603.202<br/>Aligning INOX Corner Joint MX603.202</p>  |  |
| <p><b>ACX.47.SQ</b></p> <p>Descrizione   Description<br/>Cavallotto universale<br/>External U-bolt<br/>Portata/Carring Cap. 500 kg.</p>                    | <p><b>CAMERA EUROPEA/EUROPEAN CHAMBER</b></p>  | <p><b>ACX.16.SQ</b></p> <p>Descrizione   Description<br/>Squad. a Pulsante<br/>Slot Corner Joint<br/>17.5 x 15 mm.<br/>Pulsante/Button D= 8 mm</p>   |  |
| <p><b>ACX.49.SQ</b></p> <p>Descrizione   Description<br/>Squad. Cianfrinare/Spinare<br/>Riveting/Crimping corner joint<br/>4.6 x 8.4 mm.</p>               |    | <p><b>AWX.19.SQ</b></p> <p>Descrizione   Description<br/>Squad. Avvitare/Cianfr./Spinare<br/>Screwing/Riveting/Crimping Corner Joint<br/>17.5x15 mm.<br/>Vite/Screw VIL M5X14_D= 8 mm.</p> |  |
| <p><b>ACX.50.SQ</b></p> <p>Descrizione   Description<br/>Squad. a bottone<br/>Slot Corner Joint<br/>19.3 x 9.2 mm.<br/>D=8 mm.</p>                         |    |  |   |
| <p><b>ACX.51.SQ</b></p> <p>Descrizione   Description<br/>Squad. Cianfrinare/Spinare<br/>Riveting/Crimping Corner Joint<br/>19.4 x 9.3 mm</p>               |    |  |   |



|  |   |   |   |
|--|---|---|---|
| <p><b>ACX.02.01</b><br/>Descrizione   Description<br/>Cern. Montg. rapido preassembl. 2 Ali<br/>Rapid-assembly pre-assembled 2-leafed hinge</p>                                      |    | <p><b>ACX.02.09</b><br/>Descrizione   Description<br/>Braccio telescopico per vasistas a scatto<br/>Telescopic arm for snap-fit hopper window</p>   |  |
| <p><b>ACX.02.40</b><br/>Descrizione   Description<br/>Cern. Montg. rapido preassembl. 2 Ali<br/>Rapid-assembly pre-ass. 2-leafed hinge<br/><br/>Per Terza Anta/For 3rd Door</p>      |    | <p><b>ACX.02.10</b><br/>Descrizione   Description<br/>Cerniera a compasso<br/>Compass hinge</p>   |  |
| <p><b>ACX.02.03</b><br/>Descrizione   Description<br/>Cern. Montg. rapido preassembl. 3 Ali<br/>Rapid-assembly pre-assembled 3-leafed hinge<br/><br/>Per Terza Anta/For 3rd Door</p> |    | <p><b>ACX.02.10P</b><br/>Descrizione   Description<br/>Cerniera a Scomparsa<br/>Concealed Hinge<br/><br/>Batt. 40kg   Sporg.e/o Vasistas 120kg<br/>Casmnt 40kg   Project. &amp;/or Hopper 120kg</p> |  |
| <p><b>ACX.02.41</b><br/>Descrizione   Description<br/>Cern. Montg. rapido preassembl. 3 Ali<br/>Rapid-assembly pre-ass. 3-leafed hinge<br/><br/>Per Terza Anta/For 3rd Door</p>      |  |   |   |
| <p><b>ACX.02.05</b><br/>Descrizione   Description<br/>Cerniera per vasistas apertura singola 30A°<br/>Hinge for single opening hopper window 30A°</p>                                |  |   |   |
| <p><b>ACX.02.06</b><br/>Descrizione   Description<br/>Cerniera per vasistas apertura doppia 30A°/75A°<br/>Hinge for double opening hopper window 30A°/75A°</p>                       |  |   |   |
| <p><b>ACX.02.07</b><br/>Descrizione   Description<br/>Braccio lungo per vasistas<br/>Long arm for hopper window<br/>Anta/Sash= 600-1600 mm.</p>                                      |  |   |   |
| <p><b>ACX.02.08</b><br/>Descrizione   Description<br/>Braccio Corto per vasistas<br/>Short arm for hopper window<br/>Anta/Sash= 280-800 mm.</p>                                      |  |   |   |



















|   |   |   |   |
|---|---|---|---|
| <p><b>ARX.03.04</b><br/>Descrizione   Description<br/>Martellina<br/>Martellina<br/>Sporgenza Quadro/Rosette Projection 24 mm.</p>                            |    | <p><b>ACX.03.16</b><br/>Descrizione   Description<br/>Perno di chiusura supplementare regolabile<br/>Supplementary adjustable closing pin</p> |    |
| <p><b>ARX.03.05</b><br/>Descrizione   Description<br/>Martellina con chiave<br/>Martellina w/cylinder lock<br/>Sporgenza Quadro/Rosette Projection 24 mm.</p> |    | <p><b>ACX.03.43</b><br/>Descrizione   Description<br/>Astina in poliammide<br/>POLYAMIDE bar</p>  |    |
| <p><b>ARX.03.05L DX</b><br/>Descrizione   Description<br/>Martellina DX<br/>Martellina RIGHT<br/>Sporgenza Quadro/Rosette Projection 24 mm.</p>               |  <p style="text-align: right;"><b>LOGICA</b></p>   | <p><b>ARX.03.08</b><br/>Descrizione   Description<br/>Cremonese per Anta Ribalta<br/>Cremonese bolt for awning window</p>                     |    |
| <p><b>ARX.03.05L SX</b><br/>Descrizione   Description<br/>Martellina SX<br/>Martellina LEFT<br/>Sporgenza Quadro/Rosette Projection 24 mm.</p>                |  <p style="text-align: right;"><b>LOGICA</b></p> | <p><b>ACX.03.11</b><br/>Descrizione   Description<br/>Catenacciolo a leva<br/>Lever bolt</p>  |  |
| <p><b>ARX.03.06</b><br/>Descrizione   Description<br/>Cremonese<br/>Cremonese<br/>Interasse/Centre Distance 84-92-104 mm.</p>                                 |    | <p><b>ACX.03.17</b><br/>Descrizione   Description<br/>Innesti cremonese<br/>Cremonese bolt connections</p>                                    |  |
| <p><b>ARX.03.07</b><br/>Descrizione   Description<br/>Cremonese con chiave<br/>Cremonese w/cylinder lock<br/>Interasse/Centre Distance 84-92-104 mm.</p>      |    | <p><b>ACX.03.12</b><br/>Descrizione   Description<br/>Terminale asta<br/>Bar terminal</p>   |  |
| <p><b>ARX.03.07L DX</b><br/>Descrizione   Description<br/>Cremonese DX<br/>Cremonese RIGHT<br/>Interasse/Centre Distance 84-92-104 mm.</p>                    |  <p style="text-align: right;"><b>LOGICA</b></p> | <p><b>ACX.03.18</b><br/>Descrizione   Description<br/>Terminali astina<br/>Bar terminals</p>  |  |
| <p><b>ARX.03.07L SX</b><br/>Descrizione   Description<br/>Cremonese SX<br/>Cremonese LEFT<br/>Interasse/Centre Distance 84-92-104 mm.</p>                     |  <p style="text-align: right;"><b>LOGICA</b></p> | <p><b>ACX.03.14</b><br/>Descrizione   Description<br/>Incontro asta doppio<br/>Double rod rest plate</p>                                      |  |





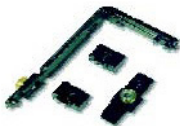











|  |   |   |  |
|--|---|---|--|
| <p><b>ACX.03.19</b><br/>Descrizione   Description<br/>Sostegno anta<br/>Door support</p>   |                      | <p><b>ACX.03.59</b><br/>Descrizione   Description<br/>Cremonese per AR c/anti falsa manovra<br/>Cremonese bolt for AR w/wrong counter-actuation</p>                           | <p>ITALIA<br/></p>  |
| <p><b>ACX.03.15</b><br/>Descrizione   Description<br/>Ferma anta<br/>Door stop</p>   |                      | <p><b>ACX.03.60</b><br/>Descrizione   Description<br/>Punto chiusura antieffrazione<br/>Anti-breakage Closure Point<br/><br/>Lav. astina tonda/Round Bar tooling D= 8 mm.</p> |   |
| <p><b>ACX.03.29</b><br/>Descrizione   Description<br/>Rostrò chiusura supplementare<br/>Supplementary closing bolt</p>   |                      | <p><b>ACX.03.61</b><br/>Descrizione   Description<br/>Sist. Sicurezza Conn. Astina<br/>Bar Connection Safety System</p>   | <p>Chiusura Anti-Effrazione<br/><br/>Anti-Breakege Closure<br/></p> |
| <p><b>ARX.03.46</b><br/>Descrizione   Description<br/>Cremonese con chiave<br/>Cremonese bolt w/cylinder lock</p>  |                    | <p><b>ACX.03.65</b><br/>Descrizione   Description<br/>Catenaccio a leva bidirezionale "bi-hid" kit<br/>Bidirectional lever bolt "BI-HID" Kit</p>                              |   |
| <p><b>ACX.03.52</b><br/>Descrizione   Description<br/>Braccio chiusura antieffrazione<br/>Anti-breakage closure arm</p>  |                    | <p><b>ACX.03.70</b><br/>Descrizione   Description<br/>Catenaccio a comando diretto Sirio<br/>Direct drive bolt SIRIO</p>  |   |
| <p><b>ACX.03.53</b><br/>Descrizione   Description<br/>Martellina c/scatto per microventilazione<br/>Martellina Handle w/Trigger for Micro-ventilation<br/>Sporgenza Quadro/Rosette Projection 24 mm.</p> | <p>ITALIA<br/></p> | <p><b>ACX.04.57</b><br/>Descrizione   Description<br/>Tappo Z-T<br/>Z-T Cap</p>   | <p>CAMERA EUROPEA/ EUROPEAN CHAMBER<br/></p>                      |
| <p><b>ACX.03.57</b><br/>Descrizione   Description<br/>Cremonese<br/>Cremonese Handle<br/>Interasse/Centre Distance 84.5-104 mm.</p>  | <p>ITALIA<br/></p> | <p><b>ACX.04.58</b><br/>Descrizione   Description<br/>Tappo Z-T<br/>Z-T Cap</p>   | <p>FERRAMENTA A NASTRO/TAPE HARDWARE<br/></p>                     |
| <p><b>ACX.03.58</b><br/>Descrizione   Description<br/>Kit base accessori per chiusura antieffrazione<br/>Base Kit Closing Accessories Anti-breakage</p>  |                    | <p><b>ARX.05.01</b><br/>Descrizione   Description<br/>Cappetta drenaggio acqua<br/>Drainage Cap</p>   |   |



|  |  |   |   |
|--|--|---|---|
| <p><b>ARX.06.01</b><br/>Descrizione   Description<br/>Registro Universale<br/>Universal Adjusting Screw</p>  |   | <p><b>ACX.08.13</b><br/>Descrizione   Description<br/>Incontro asta singolo<br/>Single bar Rest Plate</p>   |    |
| <p><b>ARX.06.02</b><br/>Descrizione   Description<br/>Piastrina Registro Universale<br/>Universal Adjusting Screw Plate</p>  |   | <p><b>ACX.08.16</b><br/>Descrizione   Description<br/>Perno chiusura supplementare<br/>Supplementary locking pin</p>  |    |
| <p><b>ARX.06.12</b><br/>Descrizione   Description<br/>Regolo mobile<br/>Adjusting Grub Screw<br/>D= 12 mm.</p>   |   | <p><b>ACX.08.18</b><br/>Descrizione   Description<br/>Chiusura supplementare inferiore orizzontale<br/>Supplementary Universal Horizontal Lower Closure</p> |    |
| <p><b>ACX.08.01</b><br/>Descrizione   Description<br/>A.R. c/anti falsa manovra<br/>Tilt &amp; Turn Door w/wrong counter-actuation<br/>Portata/Carring Cap.= 160 Kg.<br/>[Cremonese]</p>   | <p>KIT Base/Base KIT WEEN HIDE 180</p>  | <p><b>ACX.08.19</b><br/>Descrizione   Description<br/>Dispositivo microventilazione regolabile<br/>Adjustable microventilation device</p>                   |  |
| <p><b>ACX.08.01 L</b><br/>Descrizione   Description<br/>A.R. c/anti falsa manovra<br/>Tilt &amp; Turn Door w/wrong counter-actuation<br/>Portata/Carring Cap.= 160 Kg.<br/>[Cremonese]</p> | <p>KIT Base/Base KIT WEEN HIDE 180</p>  | <p><b>ACX.08.22</b><br/>Descrizione   Description<br/>Anta Ribalta Braccio Corto<br/>Short Tilt &amp; Turn arm<br/>da/from 395 a/to 450 mm.</p>             |  |
| <p><b>ACX.08.05</b><br/>Descrizione   Description<br/>A.R. Braccio Supplementare<br/>A.R. Supplementary Arm</p>  |   | <p><b>ACX.08.22 L</b><br/>Descrizione   Description<br/>Anta Ribalta Braccio Corto<br/>Short Tilt &amp; Turn Arm<br/>da/from 395 a/to 450 mm.</p>           |  |
| <p><b>ACX.08.05 L</b><br/>Descrizione   Description<br/>A.R. Braccio Supplementare<br/>A.R. Supplementary Arm</p>  |   | <p><b>ACX.08.23</b><br/>Descrizione   Description<br/>Anta Ribalta Braccio Medio<br/>Medium Tilt&amp;turn arm<br/>da/from 451 a/to 650 mm.</p>              |  |
| <p><b>ACX.08.06</b><br/>Descrizione   Description<br/>Chiusura Supplementare verticale e universale<br/>Supplementary Universal Vertical Closure</p>                                       |   | <p><b>ACX.08.23 L</b><br/>Descrizione   Description<br/>Anta Ribalta Braccio Medio<br/>Medium Tilt&amp;turn arm<br/>da/from 451 a/to 650 mm.</p>            |  |



|   |   |  |   |
|---|---|--|---|
| <p><b>ACX.08.24</b><br/>Descrizione   Description<br/>Anta Ribalta Braccio Lungo<br/>Long Tilt&amp;turn arm<br/>da/from 651 a/to 1700 mm.</p>               |    | <p><b>ACX.08.31</b><br/>Descrizione   Description<br/>Braccio Medio AR a scomparsa<br/>Tilt &amp; Turn Retractable Medium Arm<br/>DX/RIGHT</p>         | <p><b>WEEN HIDE 180</b><br/></p>                         |
| <p><b>ACX.08.24L</b><br/>Descrizione   Description<br/>Anta Ribalta Braccio Lungo<br/>Long Tilt&amp;turn arm<br/>da/from 651 a/to 1700 mm.</p>              |  <p><b>LOGICA</b></p>                                    | <p><b>ACX.08.32</b><br/>Descrizione   Description<br/>Braccio Medio AR a scomparsa<br/>Tilt &amp; Turn Retractable Medium Arm<br/>SX/LEFT</p>          | <p><b>WEEN HIDE 180</b><br/></p>                         |
| <p><b>ACX.08.25</b><br/>Descrizione   Description<br/>Kit cerniera a pettine regolabile<br/>Adjustable Comb Hinge Kit<br/>Portata/Carring Cap.= 120 Kg.</p> |    | <p><b>ACX.08.33</b><br/>Descrizione   Description<br/>Braccio Medio AR a scomparsa<br/>Tilt &amp; Turn Retractable Medium Arm<br/>DX/RIGHT</p>         | <p><b>WEEN HIDE 180</b><br/> <p><b>LOGICA</b></p> </p>   |
| <p><b>ACX.08.26</b><br/>Descrizione   Description<br/>Cerniere vasistas a scomparsa<br/>Retractable hopper window hinges</p>                                | <p><b>WEEN HIDE 180</b><br/></p>                       | <p><b>ACX.08.34</b><br/>Descrizione   Description<br/>Braccio Medio AR a scomparsa<br/>Tilt &amp; Turn Retractable Medium Arm<br/>SX/LEFT</p>          | <p><b>WEEN HIDE 180</b><br/> <p><b>LOGICA</b></p> </p> |
| <p><b>ACX.08.27</b><br/>Descrizione   Description<br/>Braccio corto AR a scomparsa<br/>Tilt &amp; Turn Retractable Short Arm<br/>DX/RIGHT</p>               | <p><b>WEEN HIDE 180</b><br/></p>                       | <p><b>ACX.08.35</b><br/>Descrizione   Description<br/>Supporto Anta<br/>Door Support<br/>Portata/Carring Cap.= 170 Kg.</p>                             | <p><b>WEEN HIDE 180</b><br/></p>                       |
| <p><b>ACX.08.28</b><br/>Descrizione   Description<br/>Braccio corto AR a scomparsa<br/>Tilt &amp; Turn Retractable Short Arm<br/>SX/LEFT</p>                | <p><b>WEEN HIDE 180</b><br/></p>                       | <p><b>ACX.08.36</b><br/>Descrizione   Description<br/>Cerniera superiore scomparsa<br/>Top Retractable Hinge<br/>DX/RIGHT</p>                          | <p><b>WEEN HIDE 180</b><br/></p>                       |
| <p><b>ACX.08.29</b><br/>Descrizione   Description<br/>Braccio corto AR a scomparsa<br/>Tilt &amp; Turn Retractable Short Arm<br/>DX/RIGHT</p>               | <p><b>WEEN HIDE 180</b><br/> <p><b>LOGICA</b></p> </p> | <p><b>ACX.08.37</b><br/>Descrizione   Description<br/>Cerniera superiore scomparsa<br/>Top Retractable Hinge<br/>SX/LEFT</p>                           | <p><b>WEEN HIDE 180</b><br/></p>                       |
| <p><b>ACX.08.30</b><br/>Descrizione   Description<br/>Braccio corto AR a scomparsa<br/>Tilt &amp; Turn Retractable Short Arm<br/>SX/LEFT</p>                | <p><b>WEEN HIDE 180</b><br/> <p><b>LOGICA</b></p> </p> | <p><b>ACX.08.38</b><br/>Descrizione   Description<br/>Cerniera superiore scomparsa<br/>Top Retractable Hinge<br/>ANTA BATTENTE DX/CASEMENT W RIGHT</p> | <p><b>WEEN HIDE 180</b><br/></p>                       |











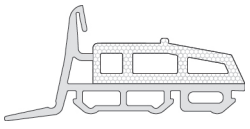



|   |   |  |  |
|---|---|--|--|
| <p><b>ACX.08.39</b><br/>Descrizione   Description<br/>Cerniera superiore scomparsa<br/><i>Top Retractable Hinge</i><br/>ANTA BATTENTE SX/CASEMENT W LEFT</p>  | <p><b>WEEN HIDE 180</b><br/></p>   | <p><b>ACX.08.48</b><br/>Descrizione   Description<br/>KIT Cerniere Anta affiancata<br/><i>AR Hinge KIT for Double Sash</i><br/>Portata/Carring Cap.= 100 Kg.</p>   | <p><b>WEEN HIDE 180</b><br/></p>    |
| <p><b>ACX.08.40</b><br/>Descrizione   Description<br/>Kit base anta ribalta c/anti falsa manovra<br/><i>Top Retractable Hinge Swing Door</i></p>  | <p><b>WEEN HIDE 180</b><br/></p>   | <p><b>ACX.08.49</b><br/>Descrizione   Description<br/>Supporto anta<br/><i>Sash Support</i><br/>Portata/Carring Cap.= 170 Kg.</p>  | <p><b>WEEN HIDE 180</b><br/></p>    |
| <p><b>ACX.08.41</b><br/>Descrizione   Description<br/>Kit base anta ribalta c/anti falsa manovra<br/><i>Top Retractable Hinge Swing Door</i><br/>da/from 651 mm. a/to 1700 mm.</p>                          | <p><b>WEEN HIDE 180</b><br/></p>   | <p><b>ACX.08.50</b><br/>Descrizione   Description<br/>Mov.unidir c/anti falsamanovra + Punto Chiusura<br/><i>Unidir. Mov. w/wrong counter-act. + Closure Point</i><br/>Entrata/Entry= 3.3<br/>Per art. ACX.08.51 - 2</p>               | <p><b>Shark minimale</b><br/></p>   |
| <p><b>ACX.08.42</b><br/>Descrizione   Description<br/>Martellina c/scatto microventilazione<br/><i>Martellina Handle w/Trigger for Micro-ventilation</i><br/>Sporgenza Quadro/Rosette Projection 24 mm.</p> | <p><b>ITALIA</b><br/></p>        | <p><b>ACX.08.51</b><br/>Descrizione   Description<br/>Martellina minimale c/scatto Microventilazione<br/><i>MARTELLINA Handle w/microventilation Trigger</i><br/>Sporgenza Quadro/Rosette Projection 24 mm.<br/>Per art. ACX.08.50</p> | <p><b>ITALIA</b><br/></p>         |
| <p><b>ACX.08.44</b><br/>Descrizione   Description<br/>Catenaccio a leva ad appoggio<br/><i>Lever bolt as support</i><br/>for the WEEN Side by Side Door<br/>Per anta affiancata Ween</p>                    | <p></p>                          | <p><b>ACX.08.52</b><br/>Descrizione   Description<br/>Martellina minimale<br/><i>Minimal MARTELLINA Handle</i><br/>Per/For art. ACX.08.50</p>  | <p><b>TWIN</b><br/></p>           |
| <p><b>ACX.08.45</b><br/>Descrizione   Description<br/>Cerniera a pettine in estruso<br/><i>Extruded Comb Hinge</i></p>  | <p></p>                          | <p><b>ACX.08.53</b><br/>Descrizione   Description<br/>Mov.unidir. c/anti falsamanovra + Punto Chiusura<br/><i>Unidir. Mov. w/wrong counter-act. + Closure Point</i><br/>Portata/Carring Cap.= 120 Kg.<br/>Per/For art. ACX.08.54-5</p> | <p><b>Shark minimale</b><br/></p> |
| <p><b>ACX.08.46</b><br/>Descrizione   Description<br/>KIT Cerniere AR<br/><i>AR Hinge KIT</i><br/>Portata/Carring Cap.= 100 Kg.</p>   | <p><b>WEEN HIDE 180</b><br/></p> | <p><b>ACX.08.54</b><br/>Descrizione   Description<br/>Martellina minimale<br/><i>Minimal MARTELLINA Handle</i><br/>Per/For art. ACX.08.53</p>  | <p><b>ITALIA</b><br/></p>         |
| <p><b>ACX.08.47</b><br/>Descrizione   Description<br/>KIT Cerniere AR<br/><i>AR Hinge KIT</i><br/>Portata/Carring Cap.= 160 Kg.</p>   | <p><b>WEEN HIDE 180</b><br/></p> | <p><b>ACX.08.55</b><br/>Descrizione   Description<br/>Martellina minimale<br/><i>Minimal MARTELLINA Handle</i><br/>Per/For art. ACX.08.53</p>  | <p><b>TWIN</b><br/></p>           |





## Guarnizioni / Gaskets

|  |   |   |  |
|--|---|---|--|
| <p><b>ACX.08.56</b><br/>Descrizione   Description<br/>Martellina minimale c/Base Rettang.<br/>Minimal MARTELLINA Handle + Square Base<br/>Interasse/Centre Distance 43 mm.<br/>Per/For art. ACX.08.53</p>    | <p>ITALIA</p>  | <p><b>ACX.10.58.1</b><br/>Descrizione   Description<br/>Guarnizione Centrale di Precamera<br/>Pre-chamber Central window gasket</p>    |  |
| <p><b>ACX.08.57</b><br/>Descrizione   Description<br/>Martellina minimale c/Base Rettang.<br/>Minimal MARTELLINA Handle + Square Base<br/>Interasse/Centre Distance 43 mm.<br/>Per/For art. ACX.08.53</p>    | <p>TWIN</p>    | <p><b>ACX.10.59</b><br/>Descrizione   Description<br/>Angolo per guarnizione centrale art. ACX.10.58.1<br/>Pre-chamber Central window gasket Corner<br/>L = 40 mm.<br/>Per/For ACX10.58.1</p>  |  |
| <p><b>ACX.08.58</b><br/>Descrizione   Description<br/>Kit deviatore e tappi<br/>Diverter Kit + Caps<br/>Profilo/Profile MX603.641</p>  |                | <p><b>AMX.10.04</b><br/>Descrizione   Description<br/>Guarnizione di battuta a scatto<br/>Snap-On Rabbet Window Gasket</p>   |  |
| <p><b>ACX.09.01</b><br/>Descrizione   Description<br/>Attrezzatura Pneumatica<br/>Pneumatic Milling hardware</p>   |              | <p><b>AMX.10.05</b><br/>Descrizione   Description<br/>Guarnizione vetro EXT<br/>External Gasket</p>    |  |
| <p><b>ARX.10.09</b><br/>Descrizione   Description<br/>Canalina per Ferramenta Nastro<br/>Conduits for tape metal-ware</p>  |              | <p><b>ARX.10.12</b><br/>Descrizione   Description<br/>Guarnizione vetro INT<br/>INT Gasket<br/>Sp./Th. = 3 - 4 mm.</p>   |  |
| <p><b>LS</b><br/>Descrizione   Description<br/>Listello isolante<br/>Insulation Shim<br/>LS 03 15x18 mm.<br/>LS 23 25x30 mm.<br/>LS 50 9x15 mm.</p>  |              | <p><b>ARX.10.13</b><br/>Descrizione   Description<br/>Guarnizione vetro INT<br/>INT Gasket<br/>Sp./Th. = 5 - 6 mm.</p>   |  |
| <p><b>ARX.10.14</b><br/>Descrizione   Description<br/>Guarnizione vetro INT<br/>INT Gasket<br/>Sp./Th. = 7 - 8 mm.</p>  |   | <p><b>ARX.10.15</b><br/>Descrizione   Description<br/>Guarnizione vetro INT<br/>INT Gasket<br/>Sp./Th. = 9 - 10 mm.</p>    |  |

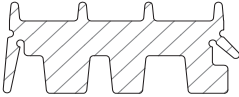
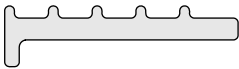
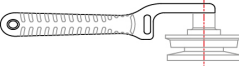

|  |   |
|--|---|
| <p><b>ACX.10.71</b></p> <p>Descrizione   Description<br/>Articolo per fermavetro di sicurezza (a pezzi)<br/>Item for safety glazing bead (in pieces)</p> |    |
| <p><b>ARX.10.73</b></p> <p>Descrizione   Description<br/>Guarnizione sotto vetro<br/>Window gasket under glass</p>                                       |    |
| <p><b>ACX.10.81</b></p> <p>Descrizione   Description<br/>Guarnizione sotto vetro<br/>Window gasket under glass</p>                                       |    |
| <p><b>ARX.10.27</b></p> <p>Descrizione   Description<br/>Rotella infila guarnizioni<br/>Window gasket threader</p>                                       |  |

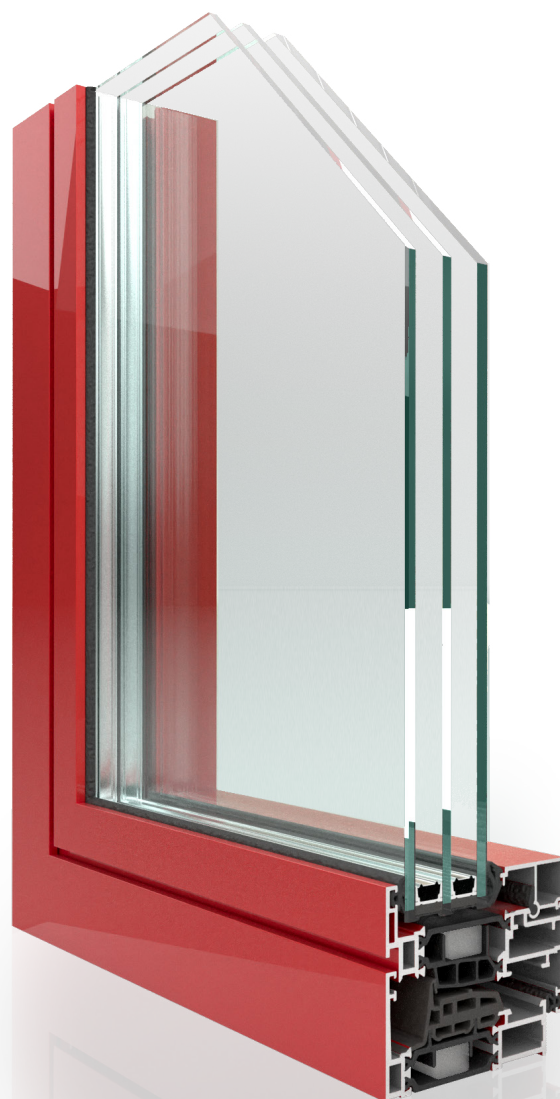

**Nodi**  
*Main Sections*

**Gruppo D**

Sezioni principali  
e Accessori  
Sc. 1:1

*Main Sections and  
Accessories  
Scale 1:1*





SCHEMA DIMENSIONALE  
DIMENSIONAL SCHEME

**CAMERA EUROPEA**  
EUROPEAN CHAMBER

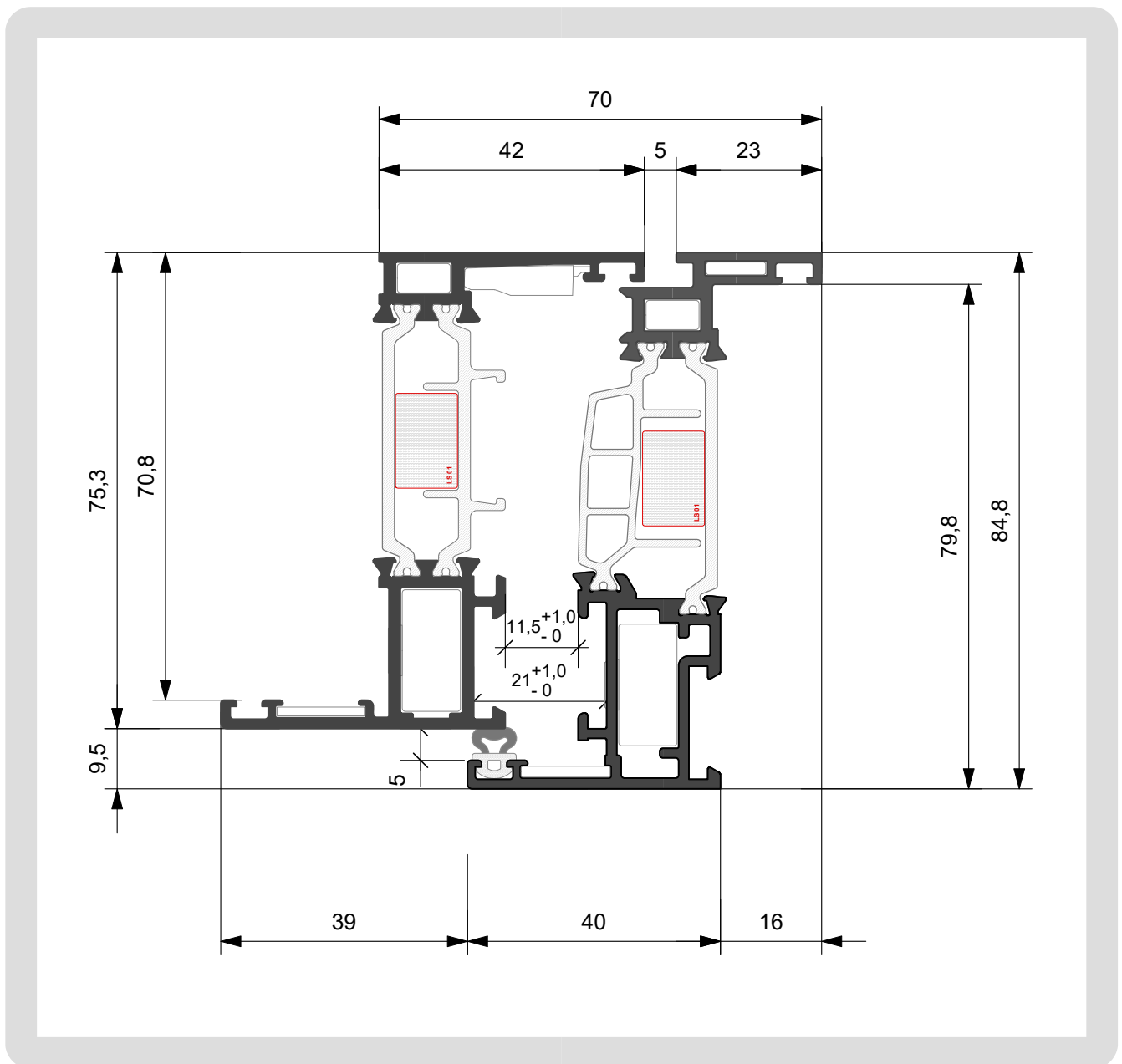



SCHEMA DIMENSIONALE  
DIMENSIONAL SCHEME

FERRAMENTA A NASTRO  
TAPE HARDWARE

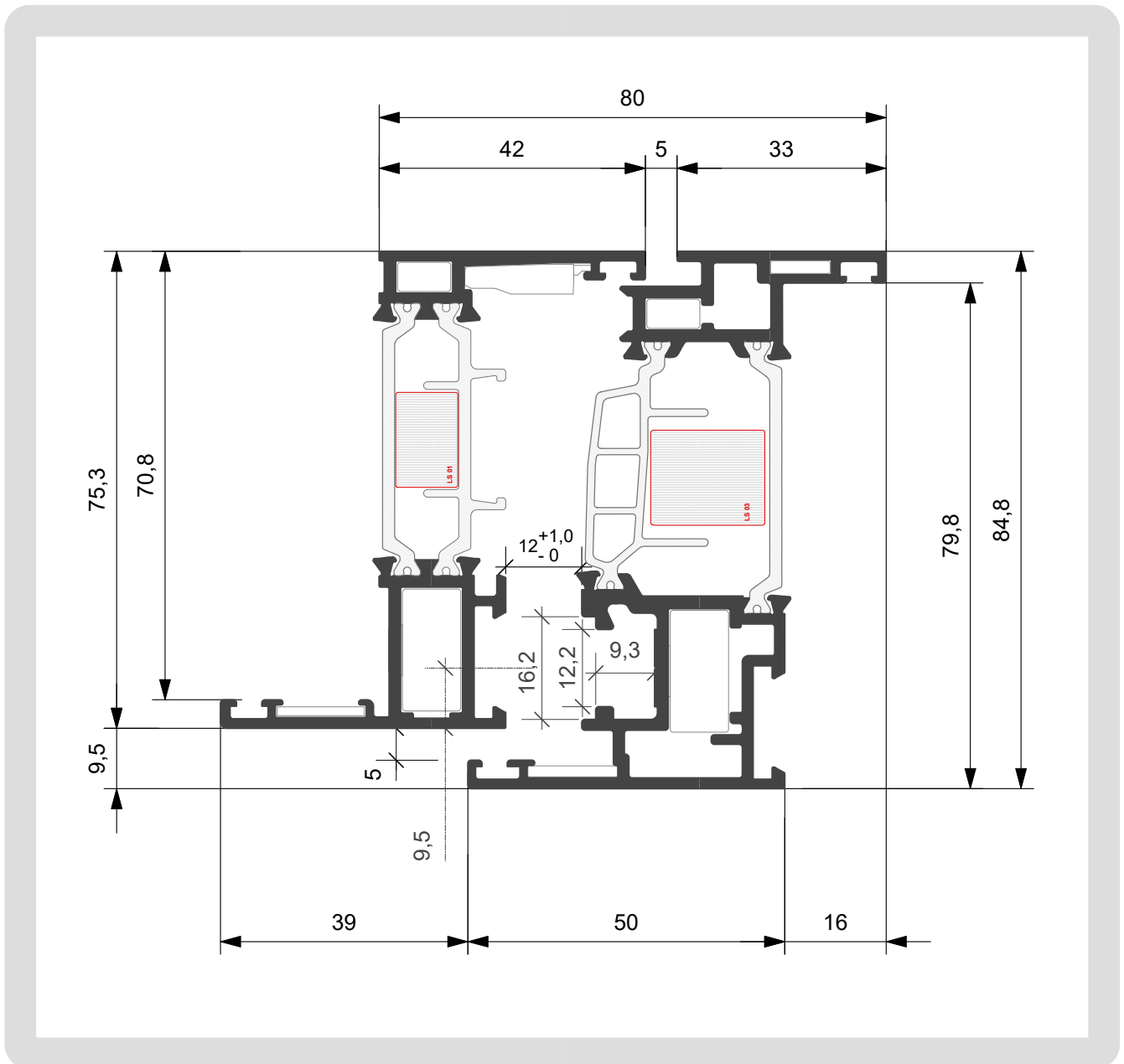



**FINESTRA A DUE ANTE**  
**Anta MX753.235**  
**DOUBLE SASH WINDOW**

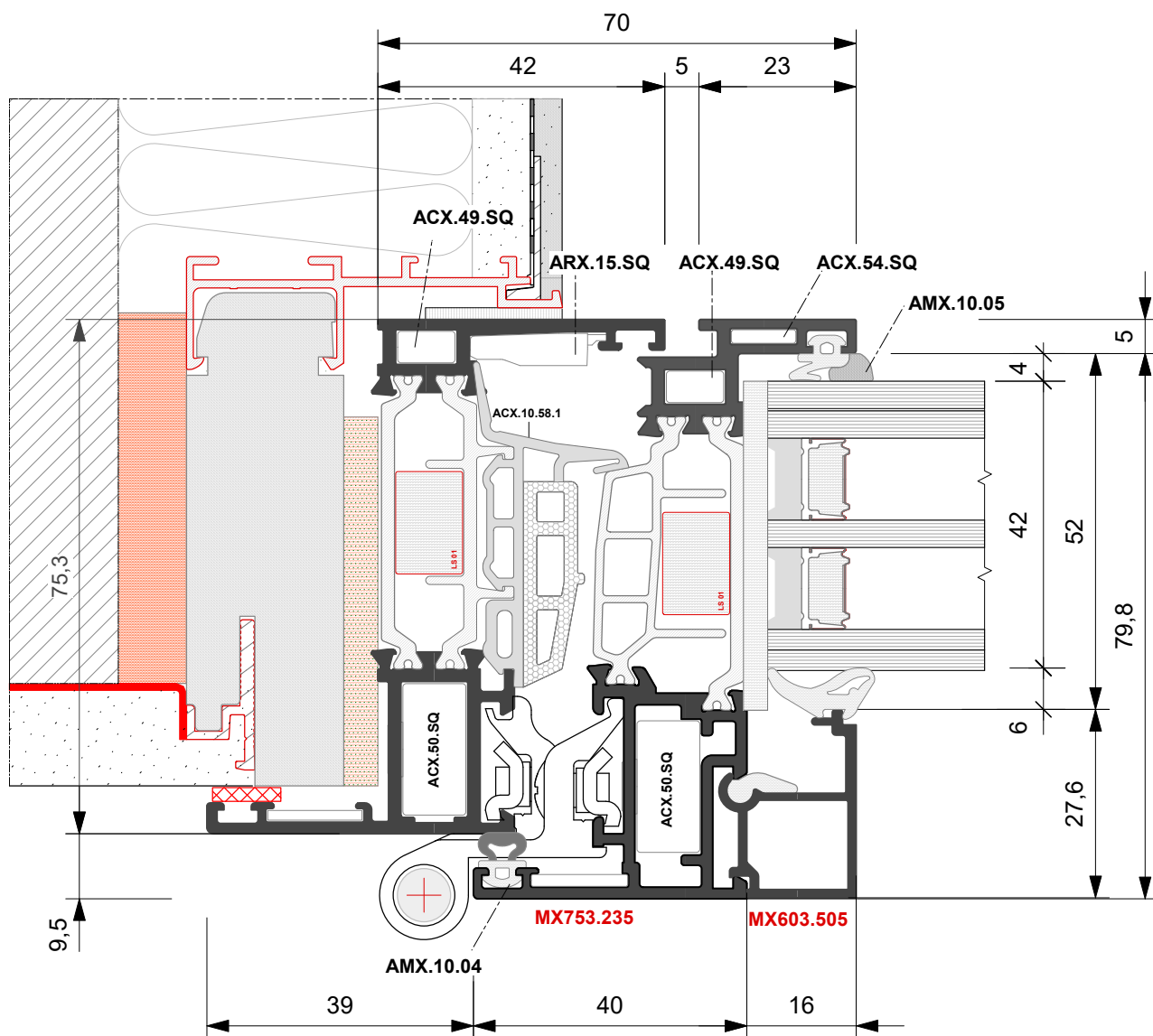
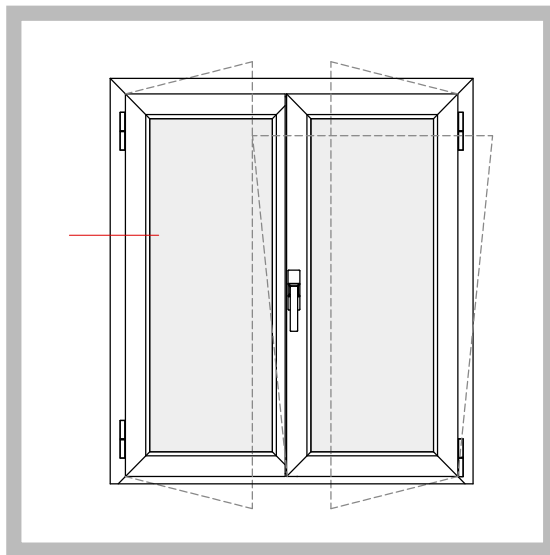



**FINESTRA A DUE ANTE**  
**Anta MX753.235**  
*DOUBLE SASH WINDOW*

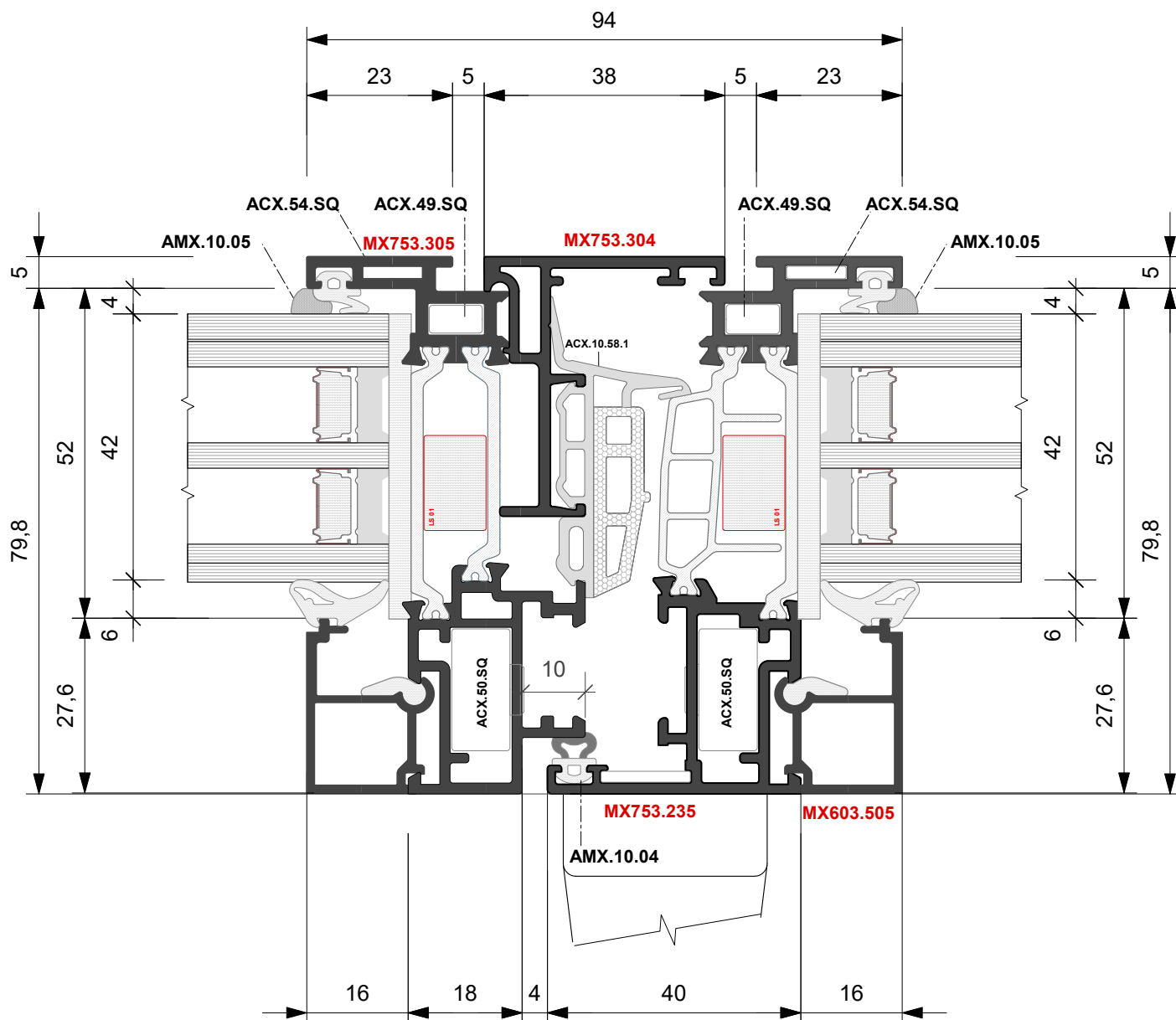
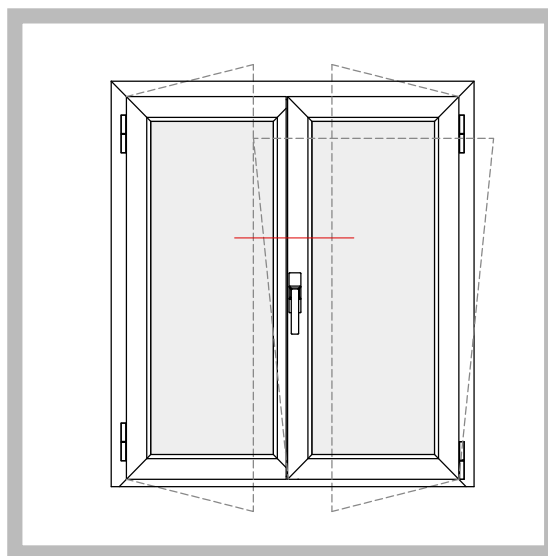





**FINESTRA A DUE ANTE**  
**Anta MX753.235**  
**DOUBLE SASH WINDOW**

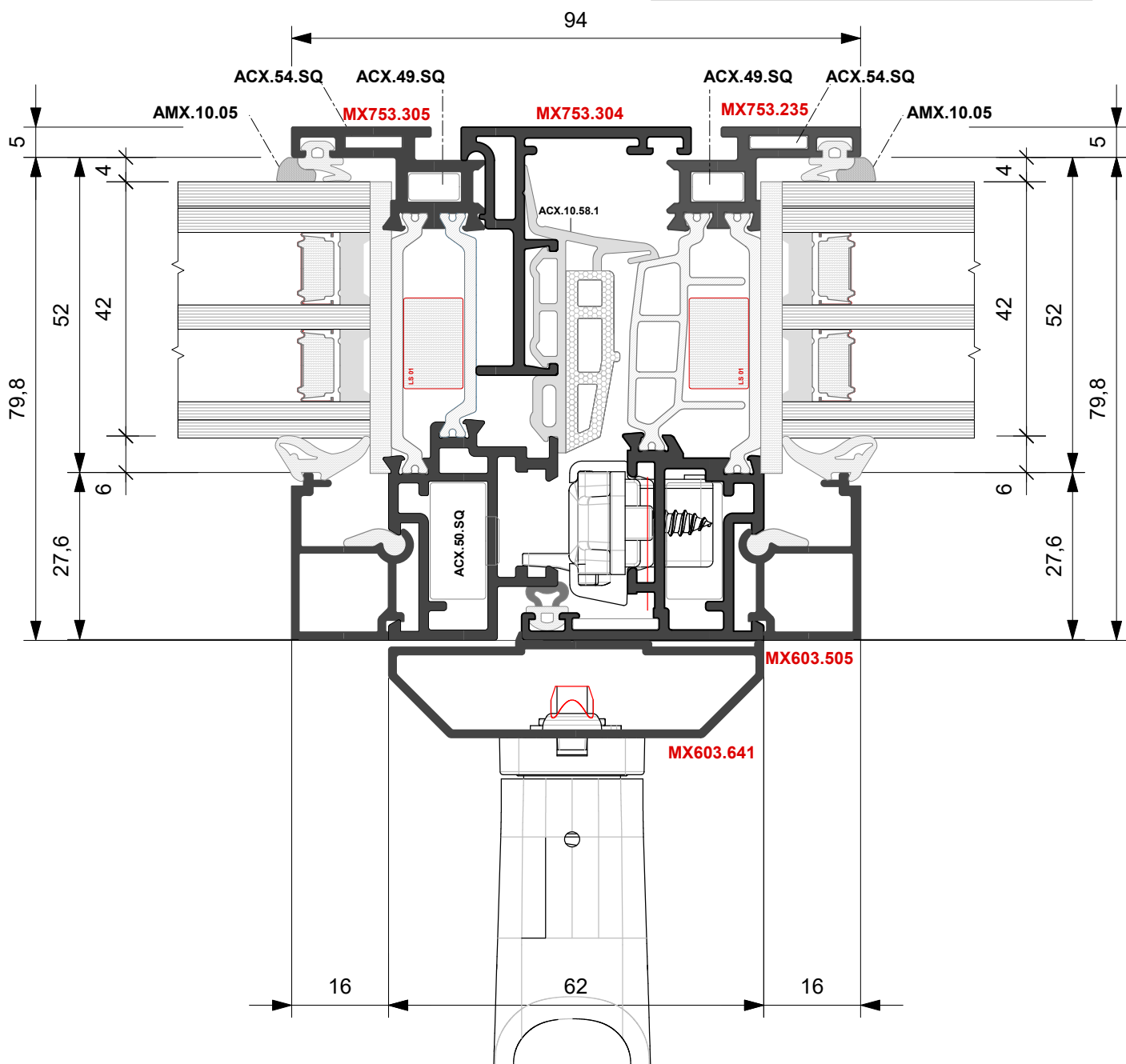
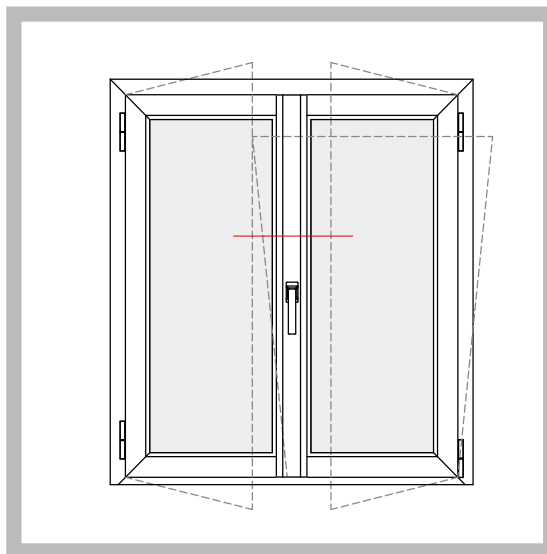



**FINESTRA A DUE ANTE**  
**Anta MX753.235**  
**DOUBLE SASH WINDOW**

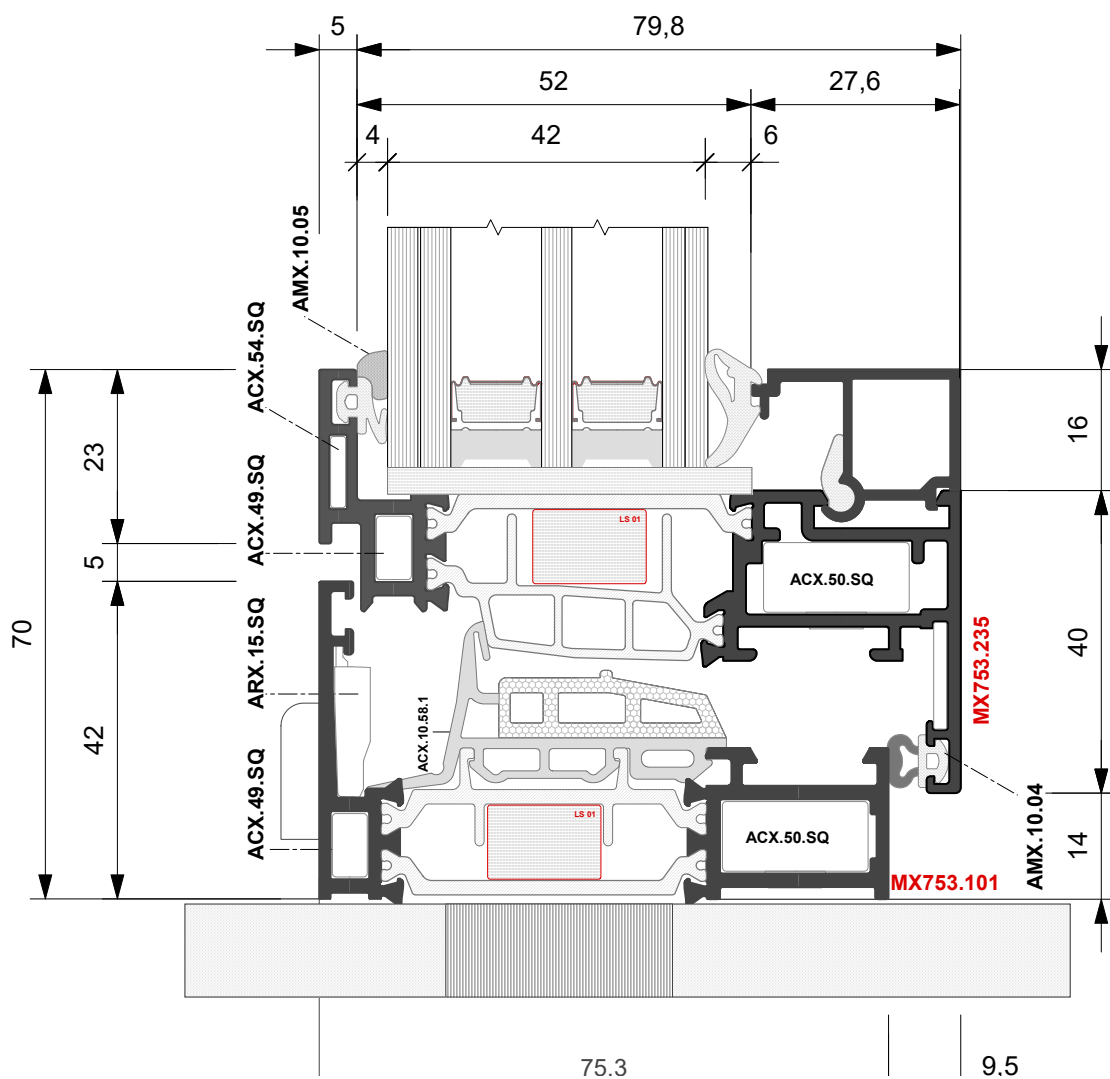
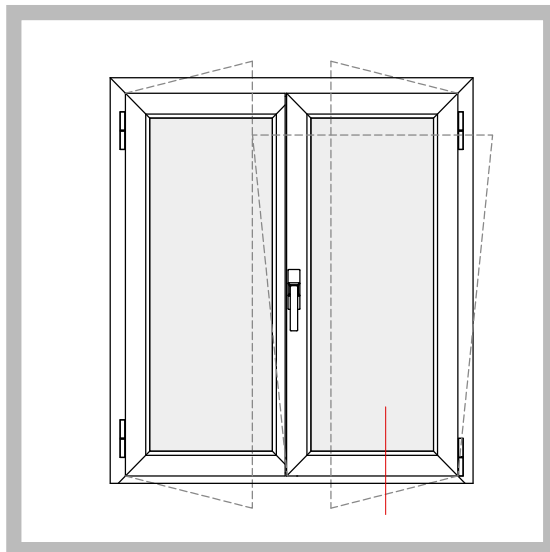



**PORTA BALCONE A DUE ANTE**  
**Anta MX753.235**

*DOUBLE SASH BALCONY DOOR*

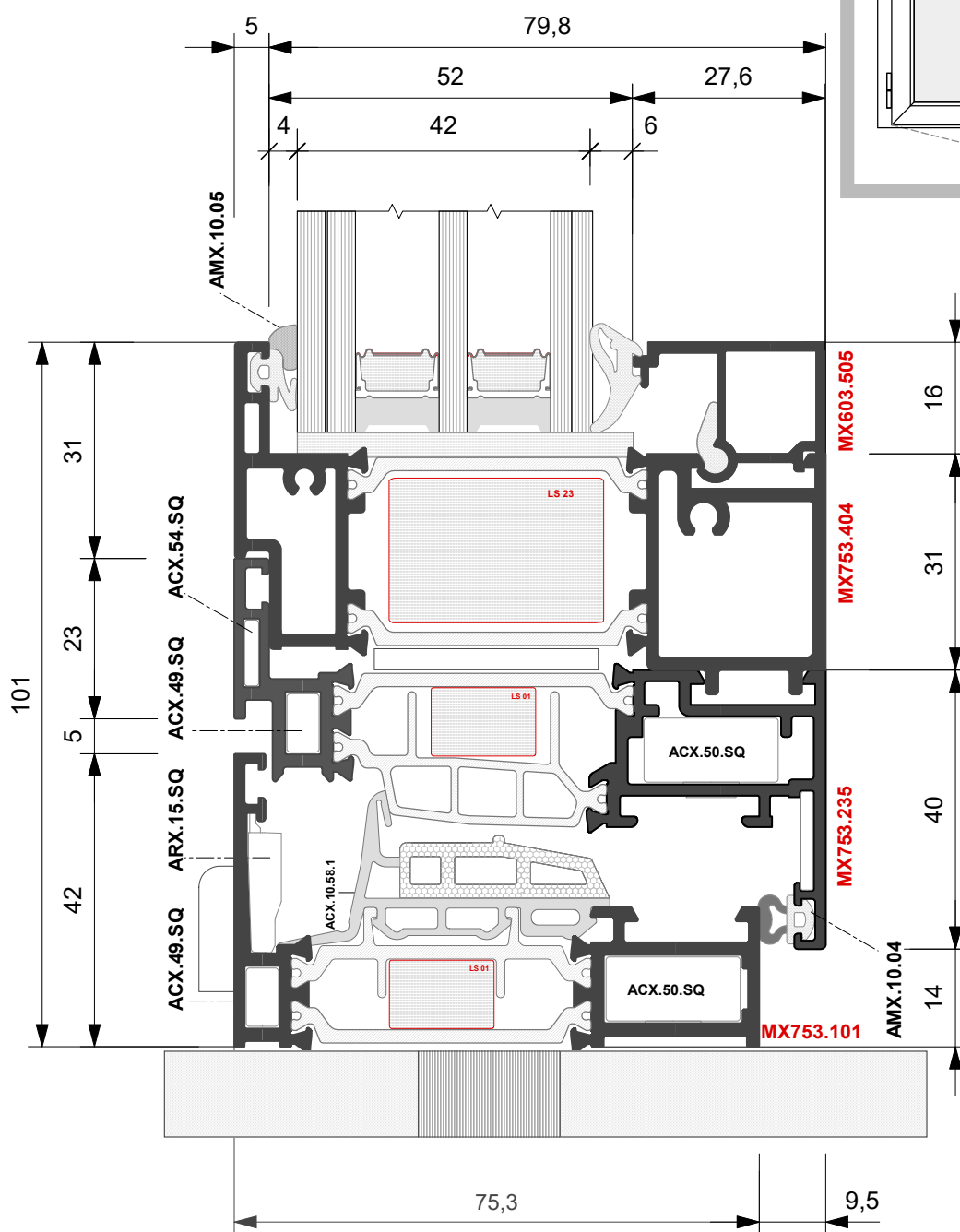
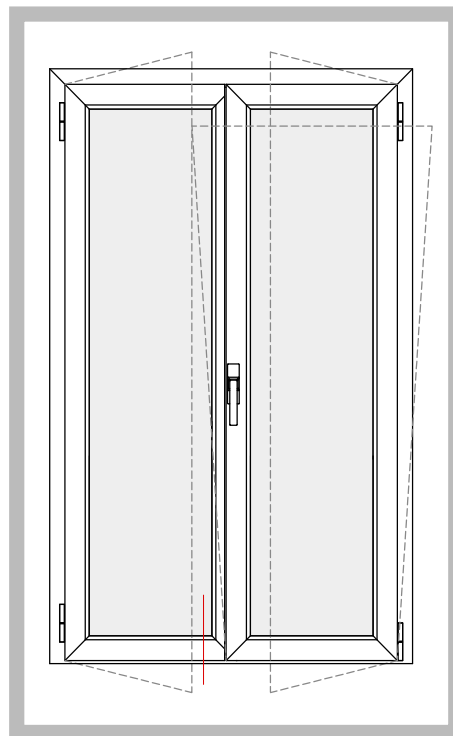

**FERRAMENTA A NASTRO**  
TAPE HARDWARE



**FINESTRA A DUE ANTE**  
**Anta MX753.204**  
DOUBLE SASH WINDOW

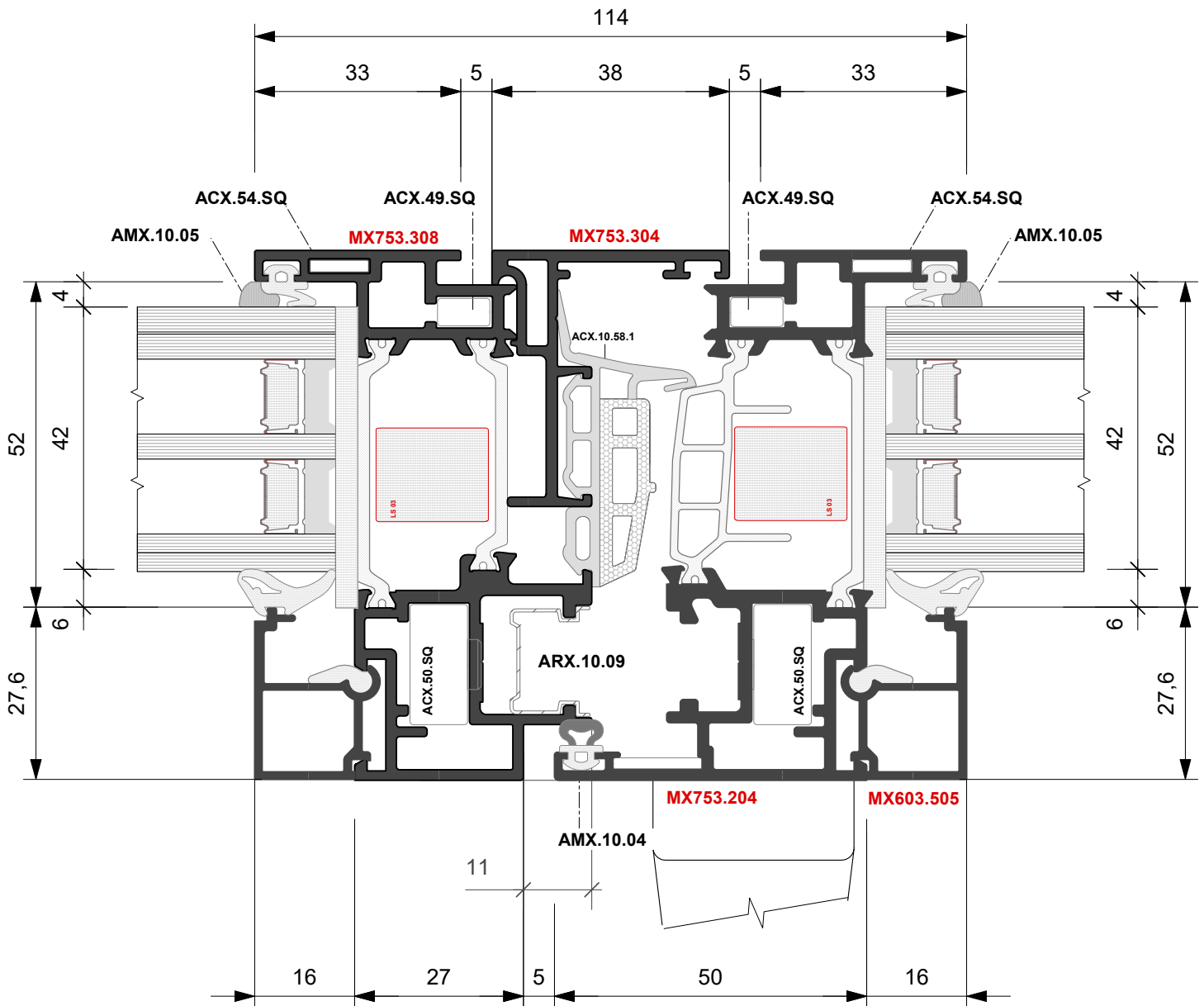
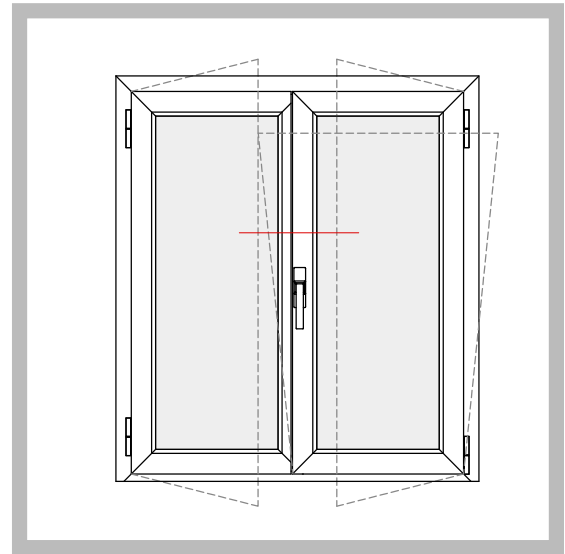

**FERRAMENTA A NASTRO**  
TAPE HARDWARE



**PORTA BALCONE A DUE ANTE**  
**Anta MX753.204**  
DOUBLE SASH WINDOW

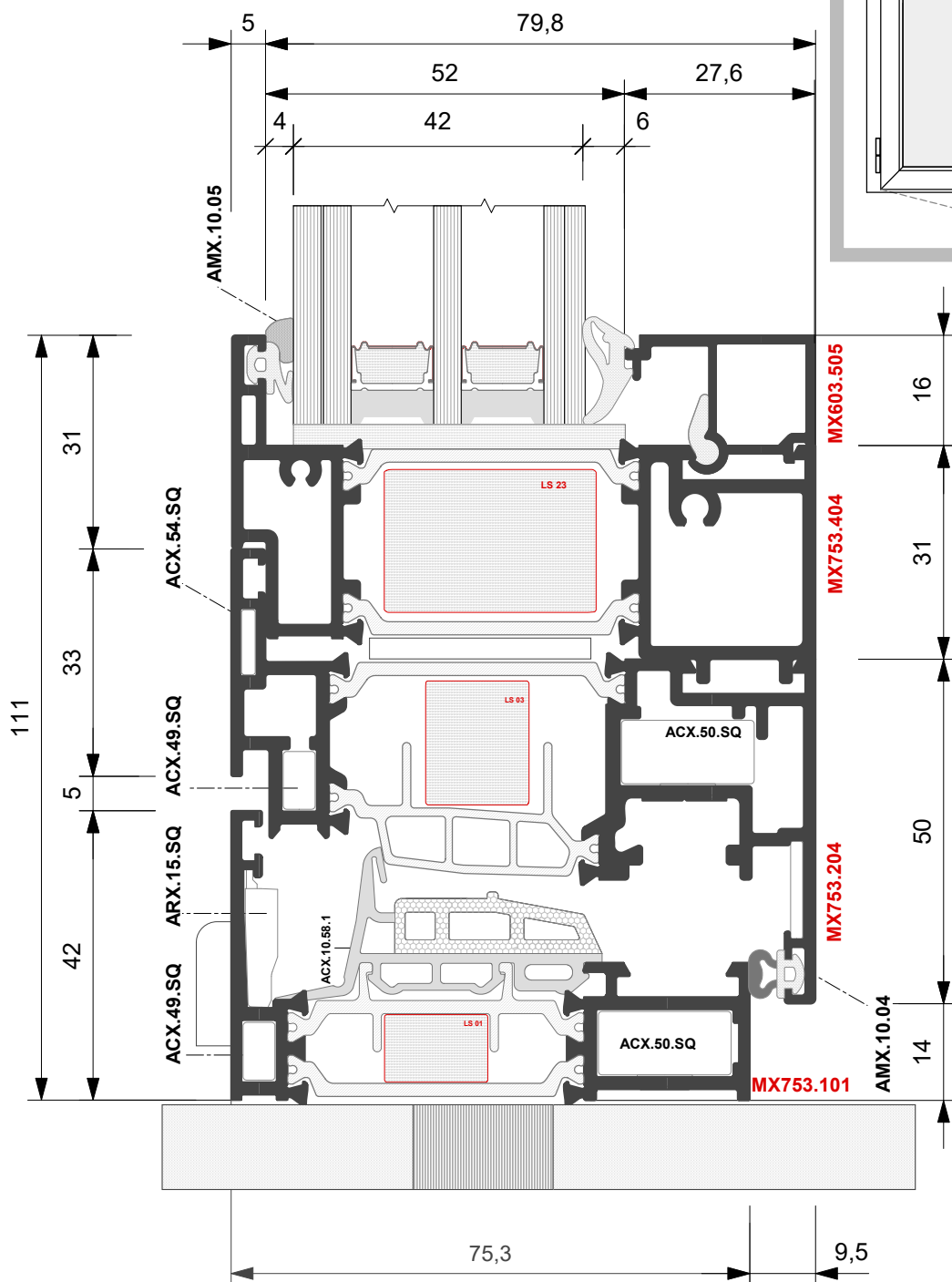
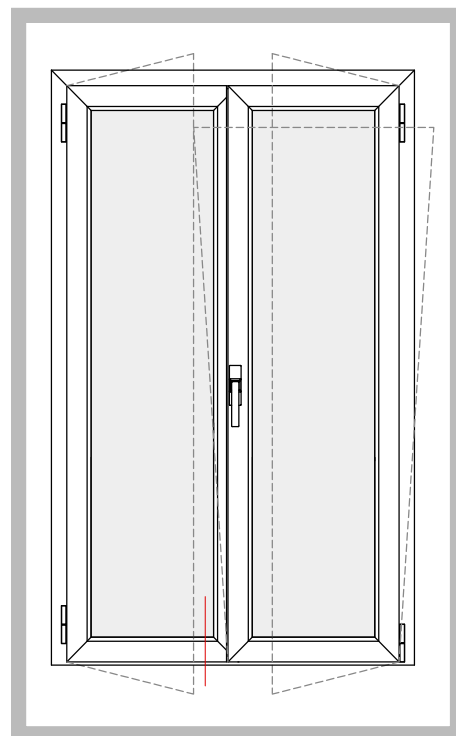



**FINESTRA A DUE ANTE**  
**Anta MX753.202**  
**DOUBLE SASH WINDOW**

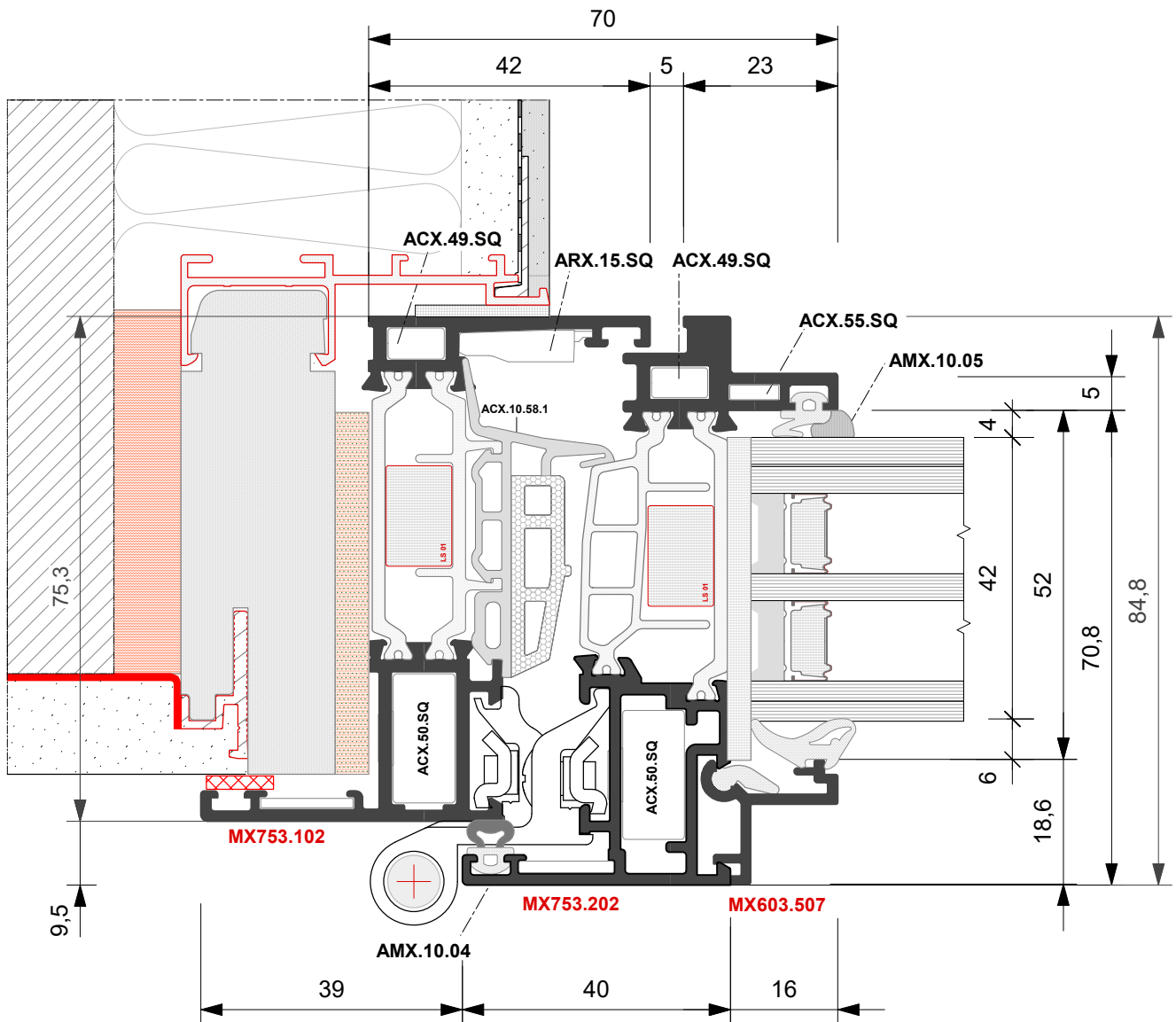
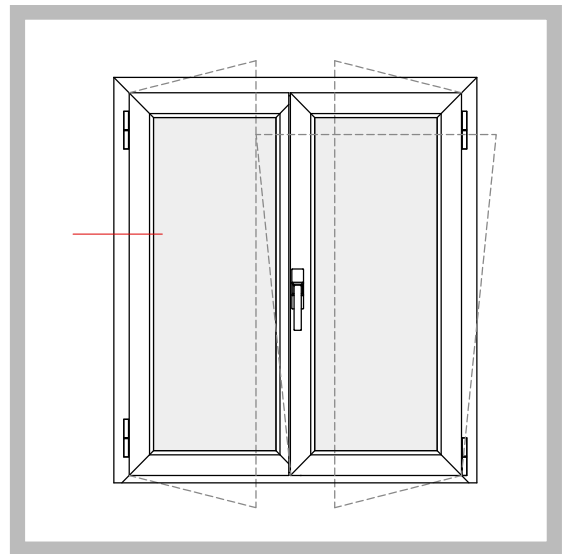



**FINESTRA A DUE ANTE**  
**Anta MX753.202**  
**DOUBLE SASH WINDOW**

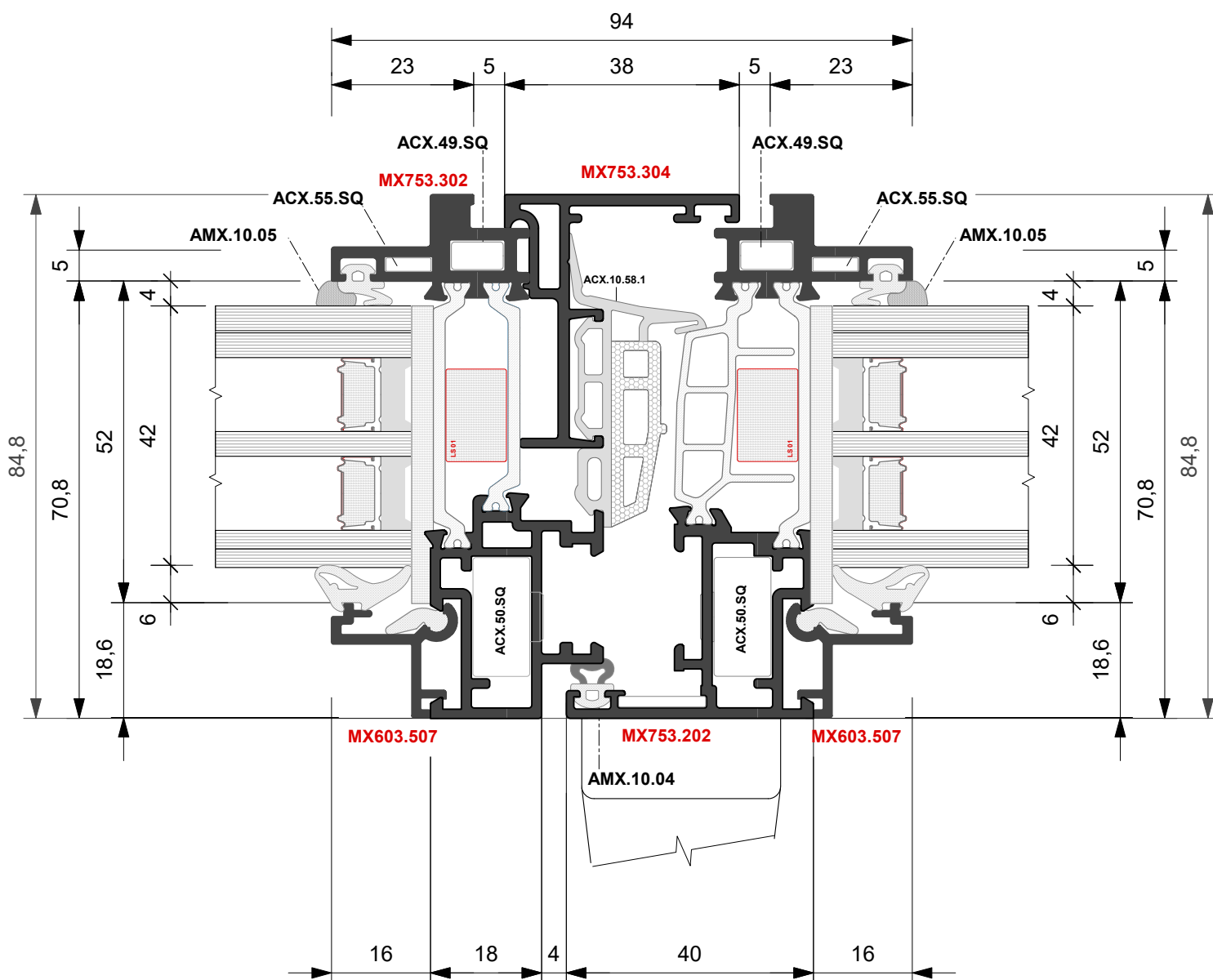
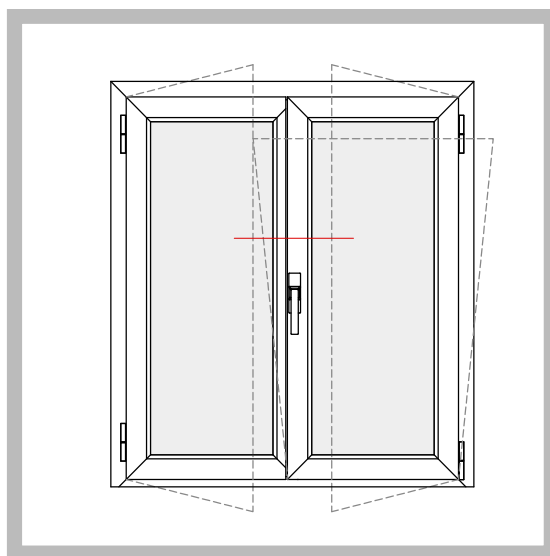



**FINESTRA A DUE ANTE**  
**Anta MX753.202**  
*DOUBLE SASH WINDOW*

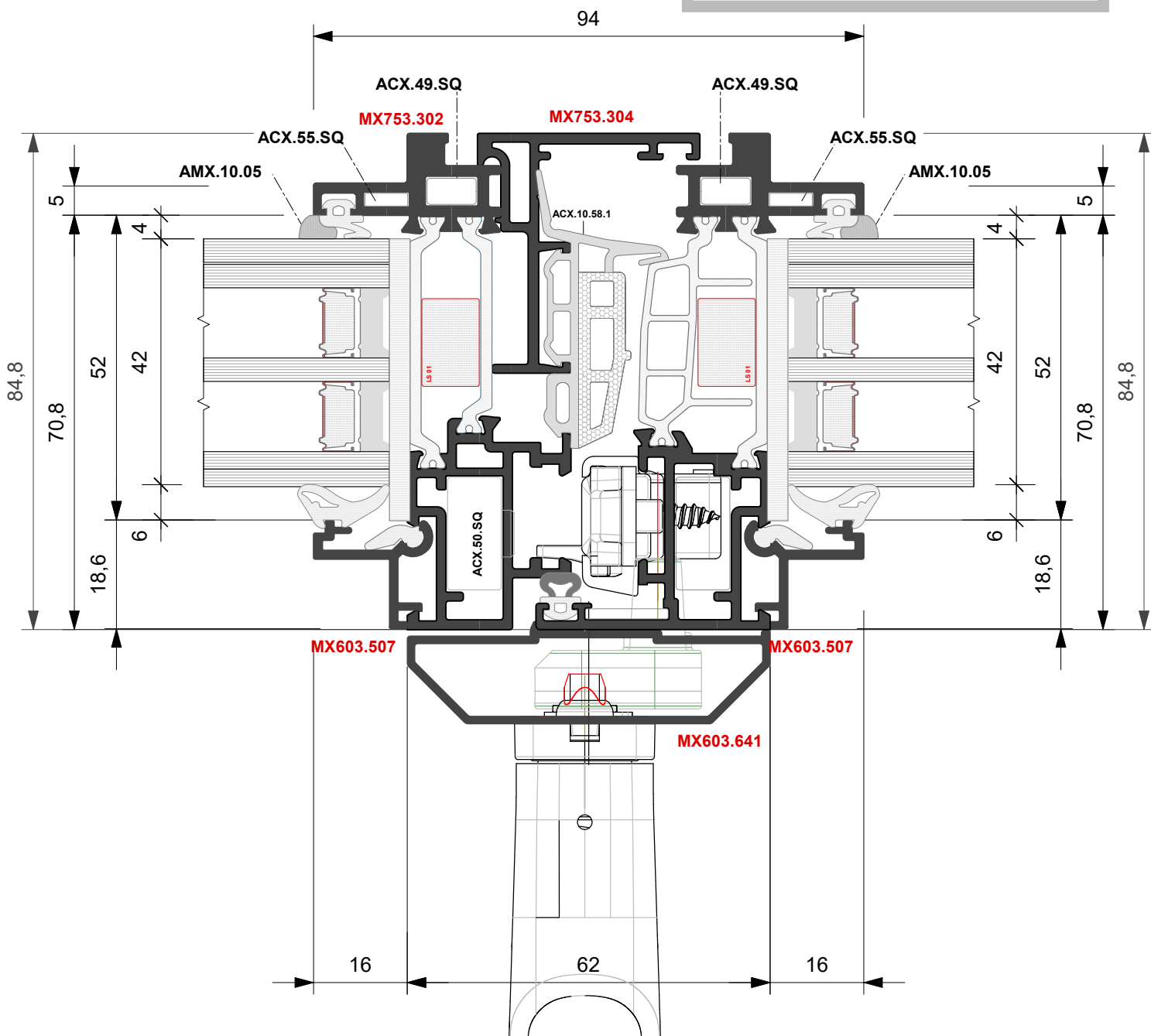
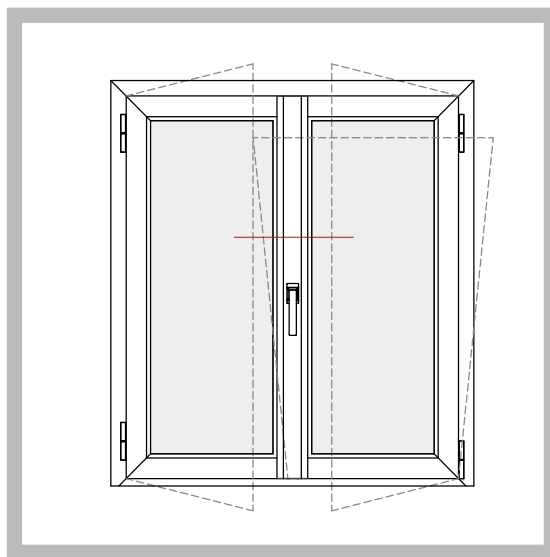





**FINESTRA A DUE ANTE**  
**Anta MX753.202**  
*DOUBLE SASH WINDOW*

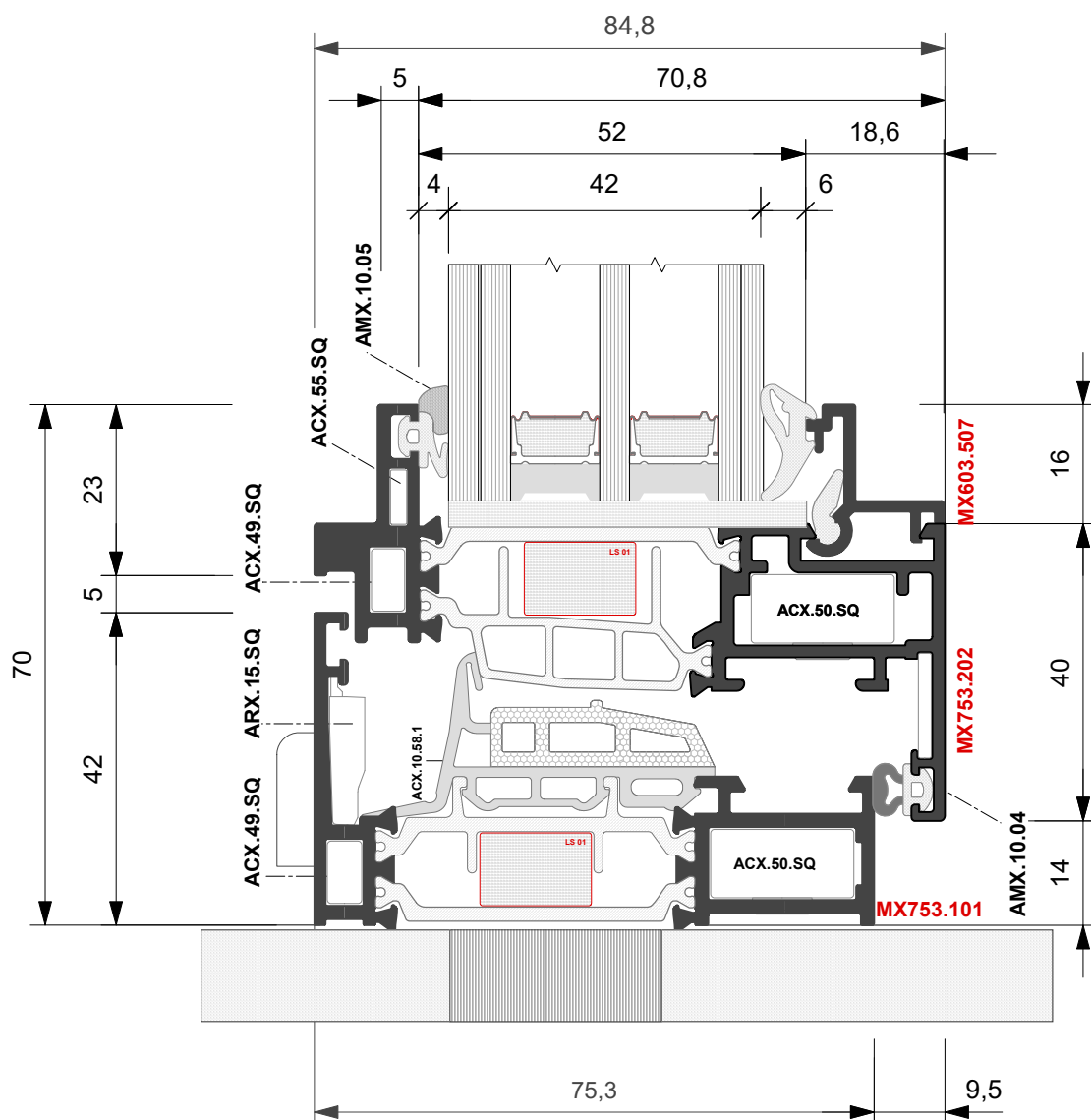
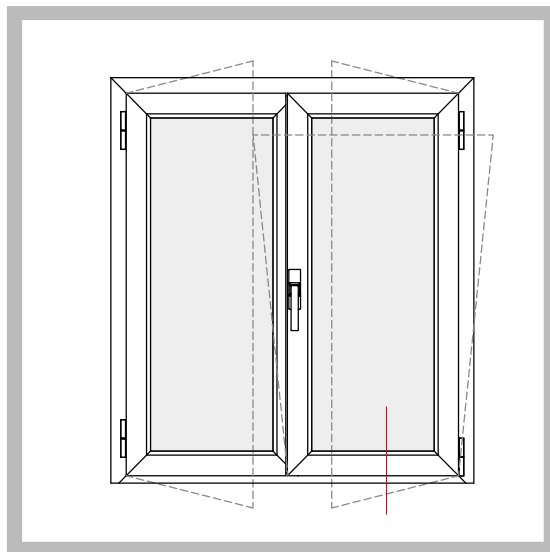



**PORTA BALCONE A A DUE ANTE**  
**Anta MX753.202**  
*DOUBLE SASH BALCONY DOOR*

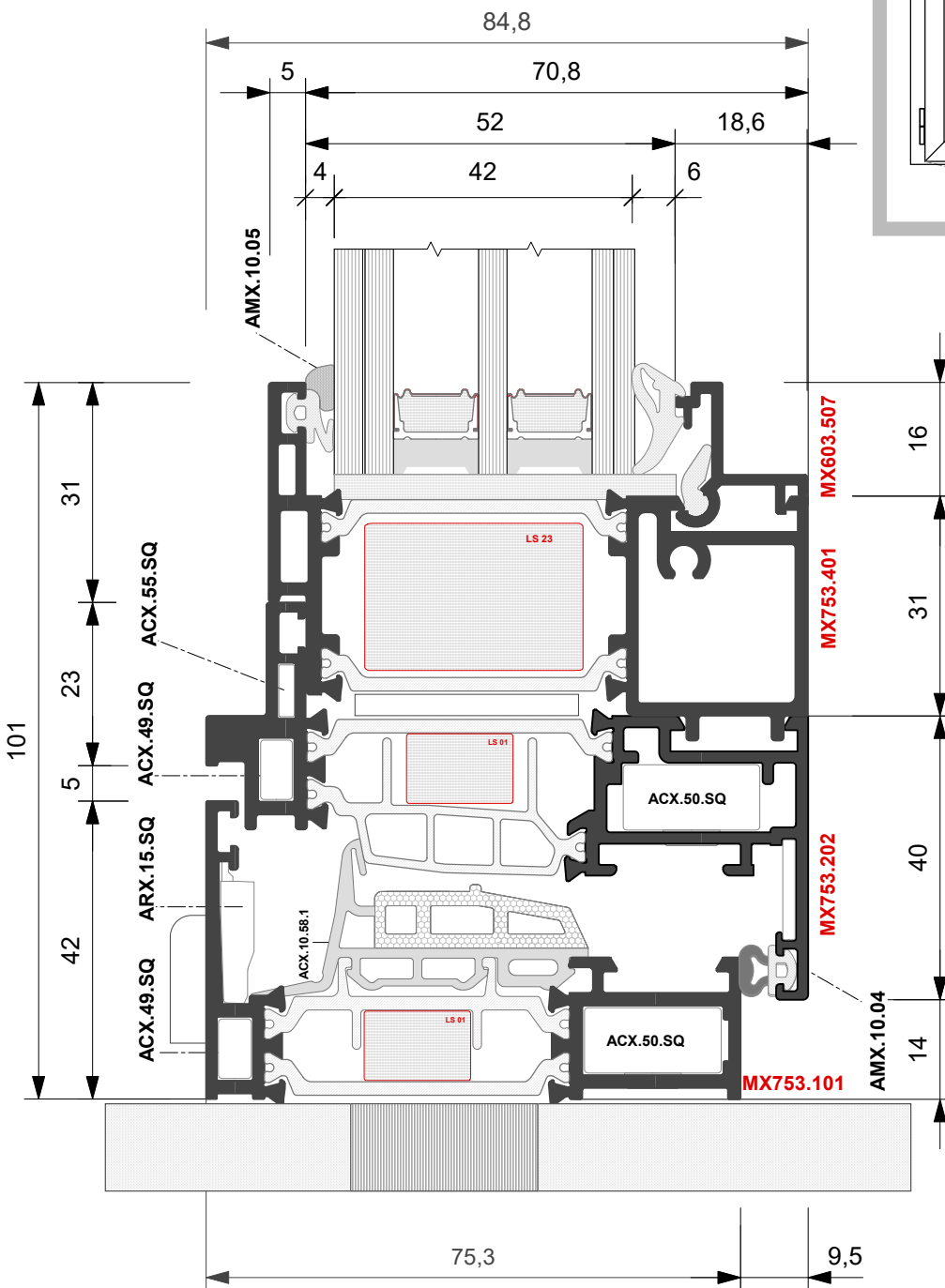
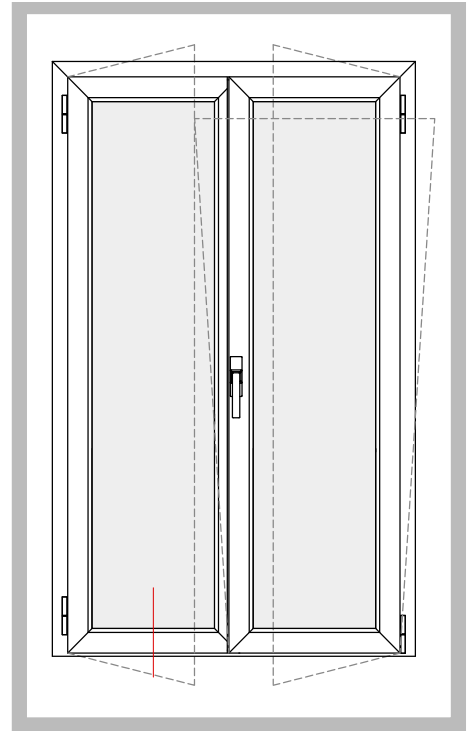

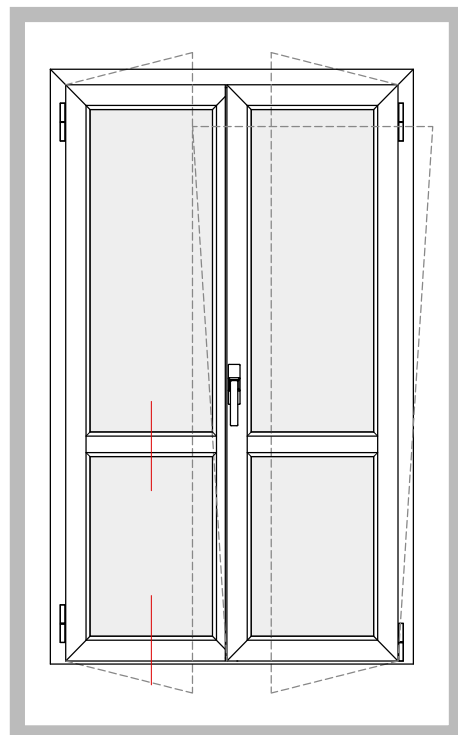
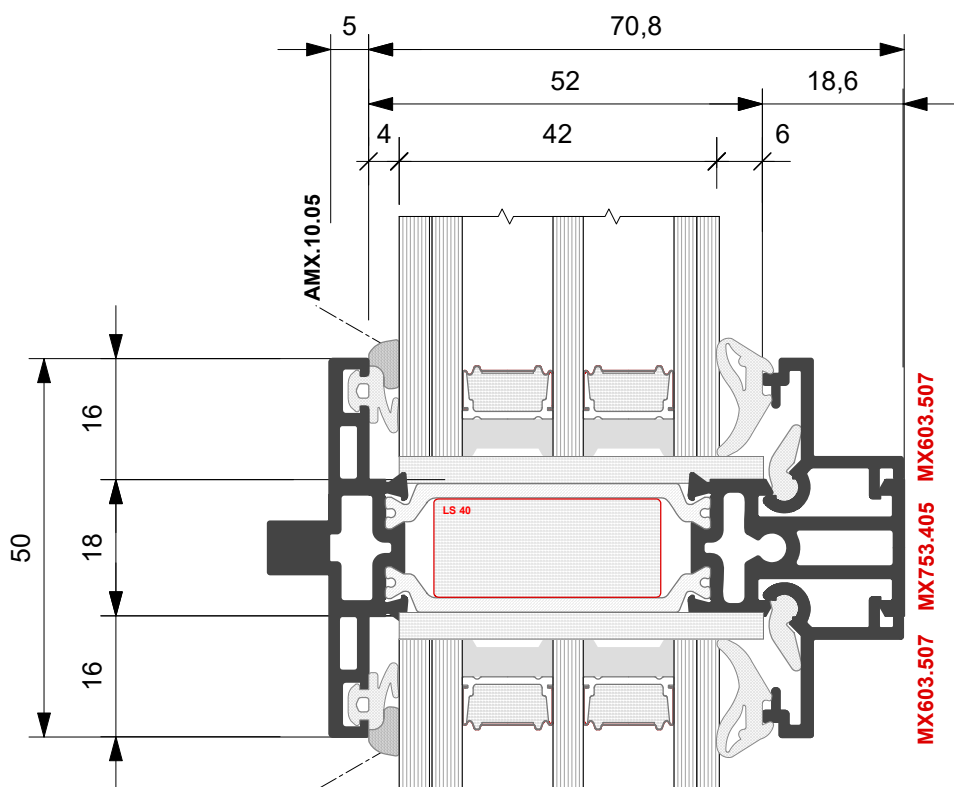

**PORTA BALCONE A DUE ANTE**  
**Anta MX753.202**  
*DOUBLE SASH BALCONY DOOR*

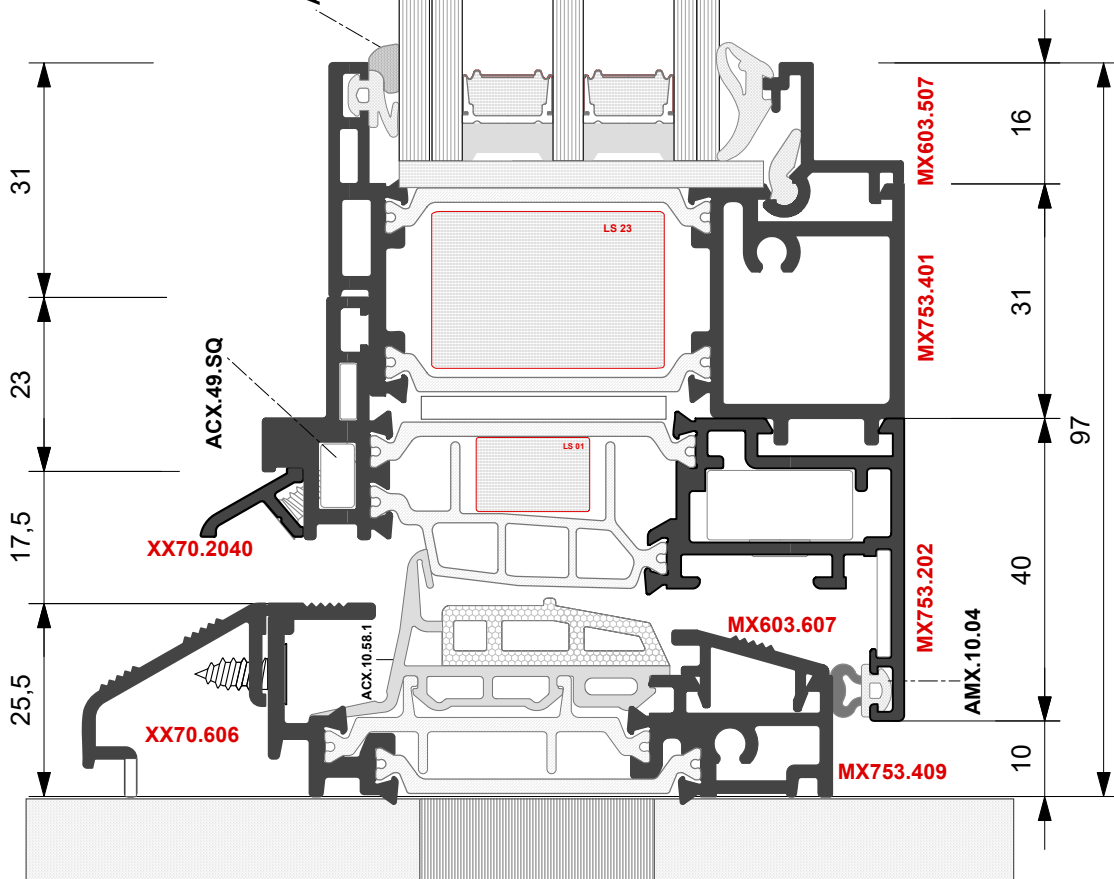



**FINESTRA A DUE ANTE**  
**Anta MX753.201**  
**DOUBLE SASH WINDOW**

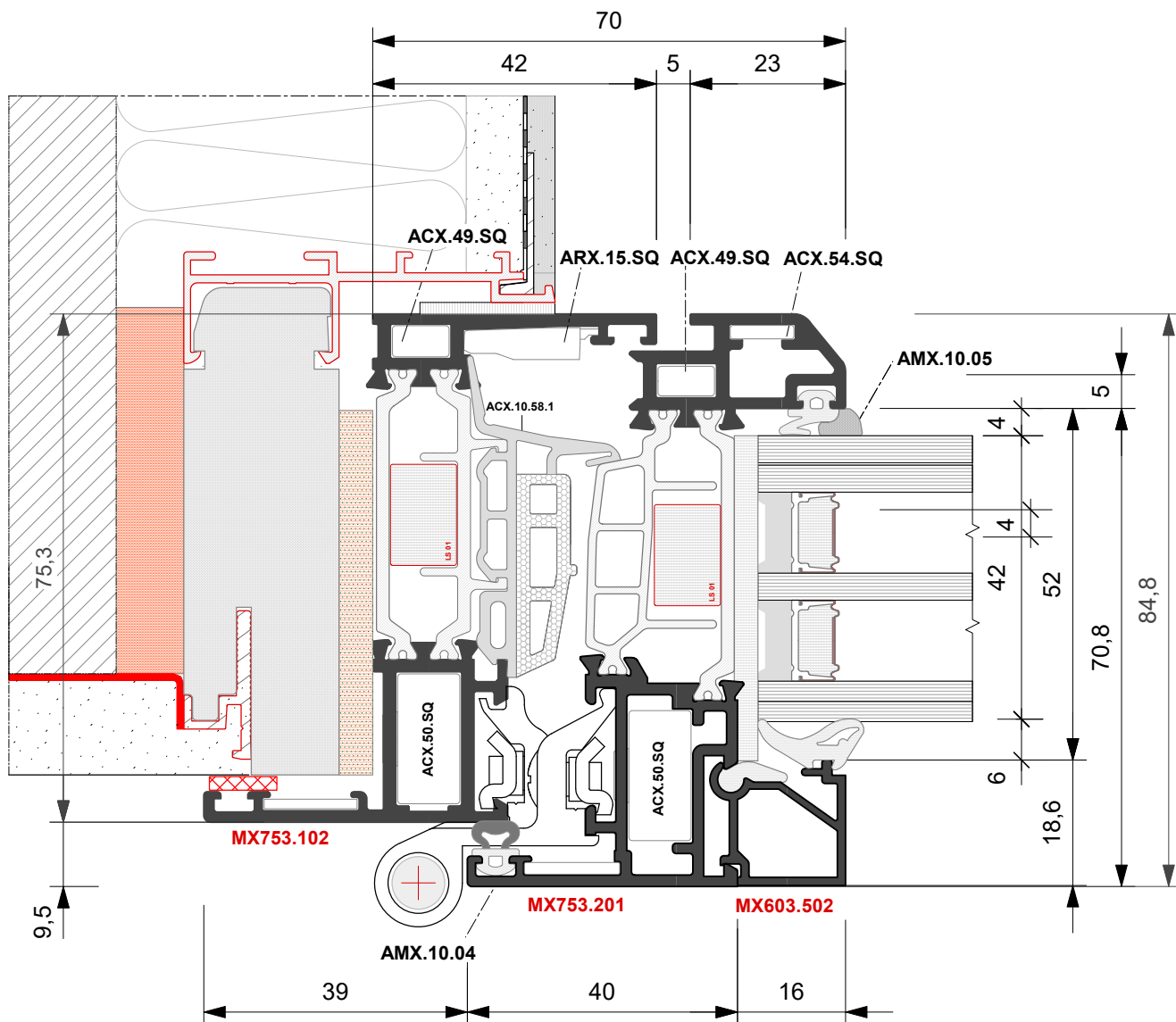
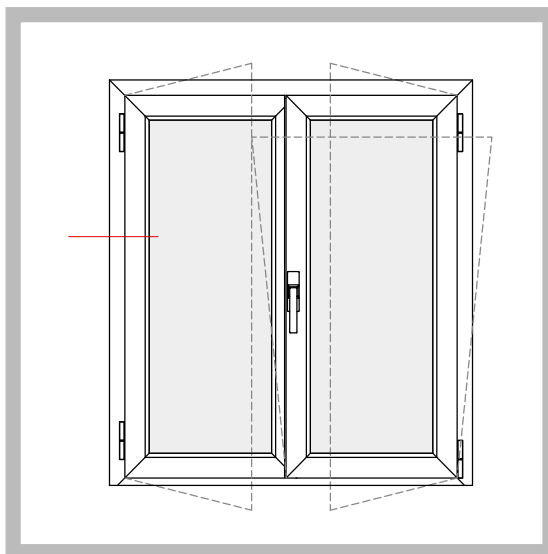



**FINESTRA A DUE ANTE**  
**Anta MX753.201**  
DOUBLE SASH WINDOW

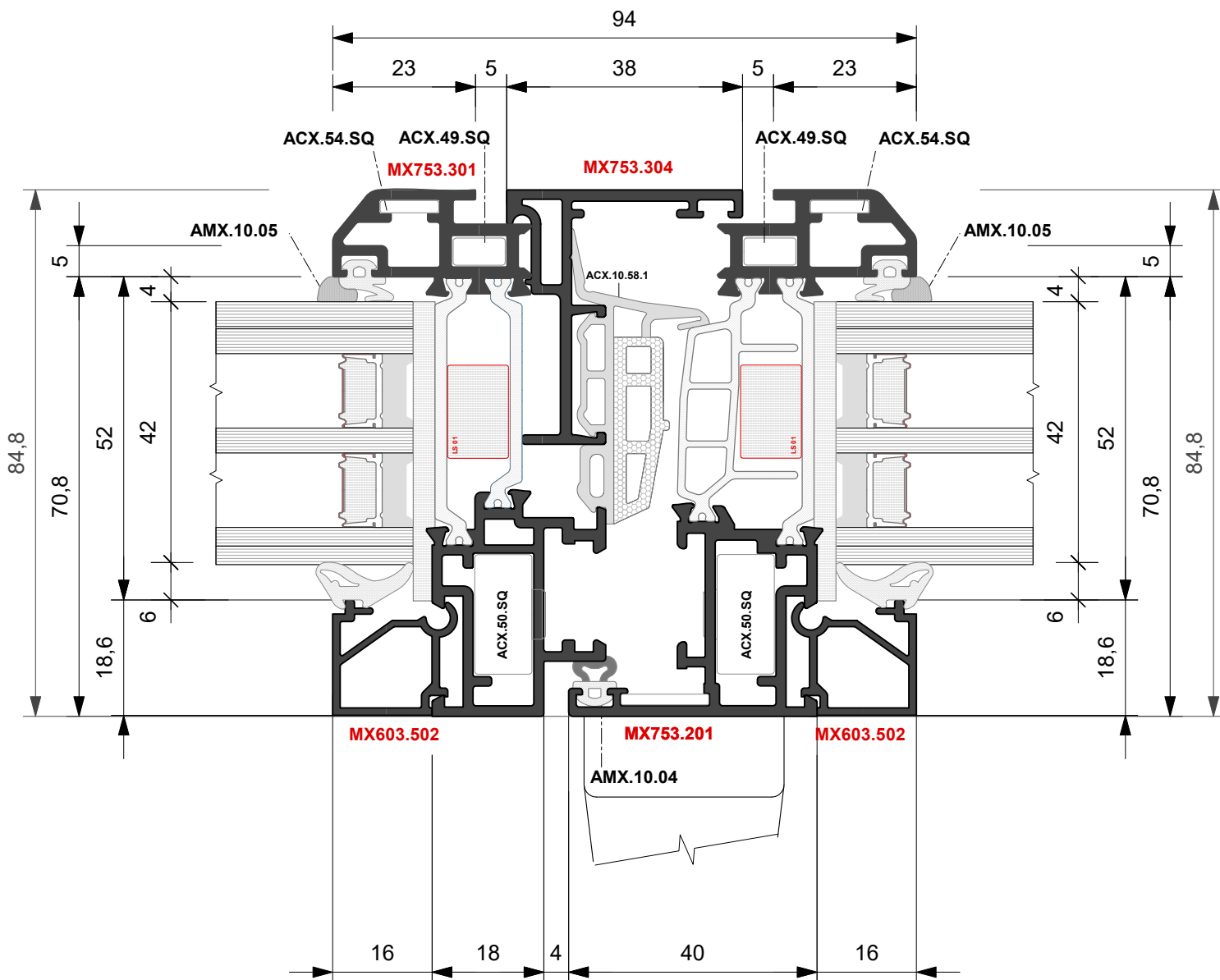
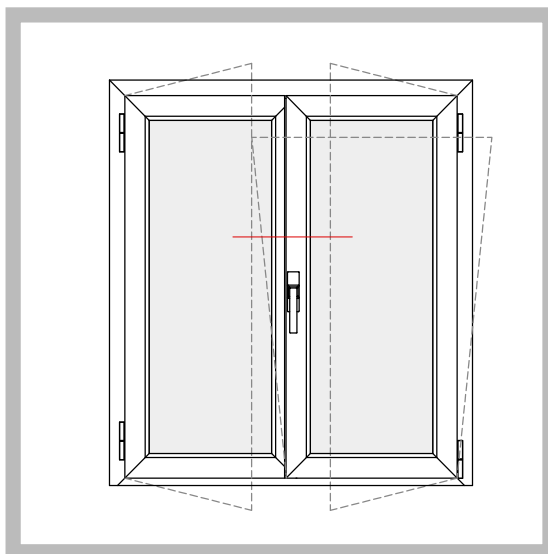



**FINESTRA A DUE ANTE**  
**Anta MX753.201**  
DOUBLE SASH WINDOW

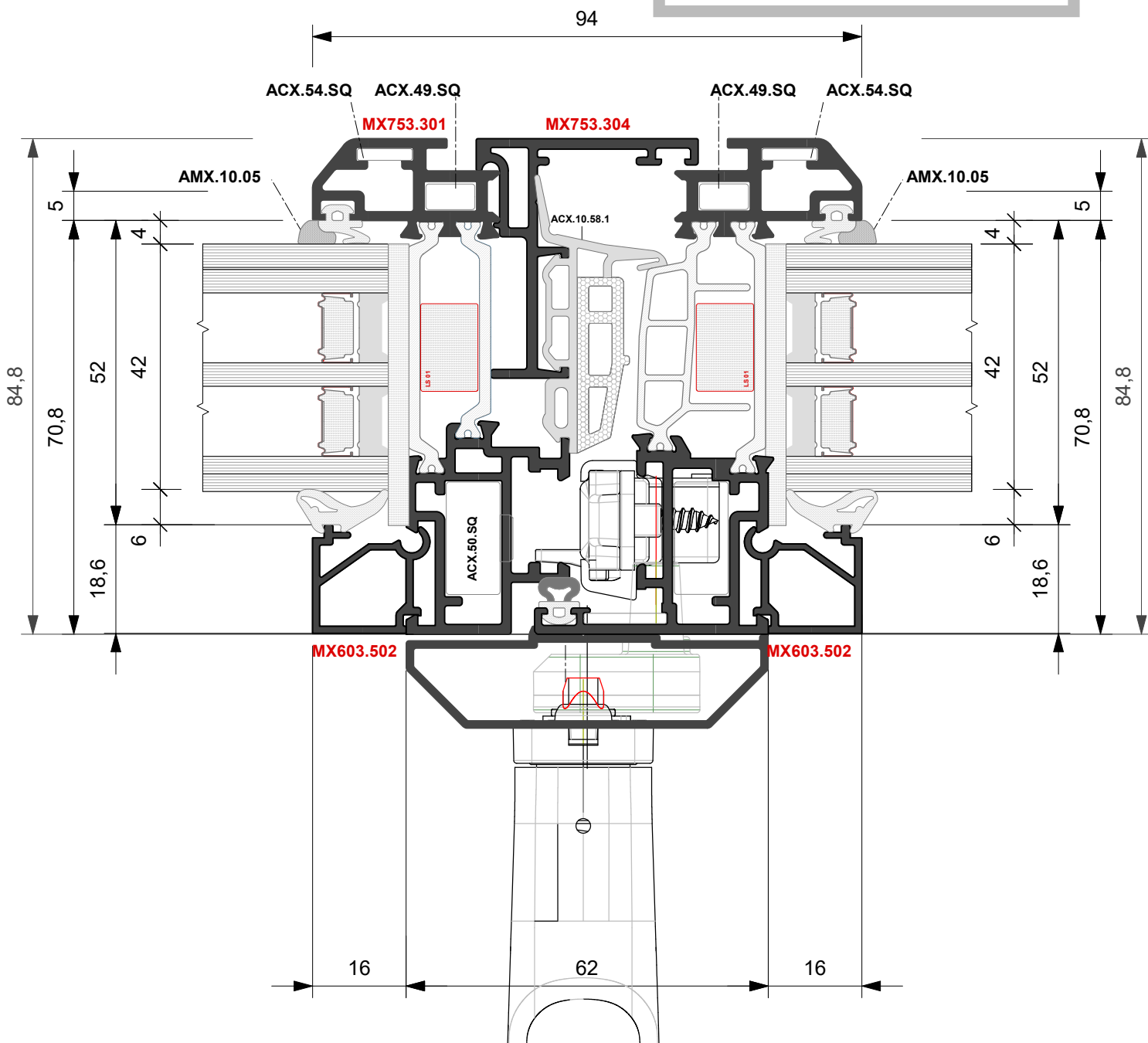
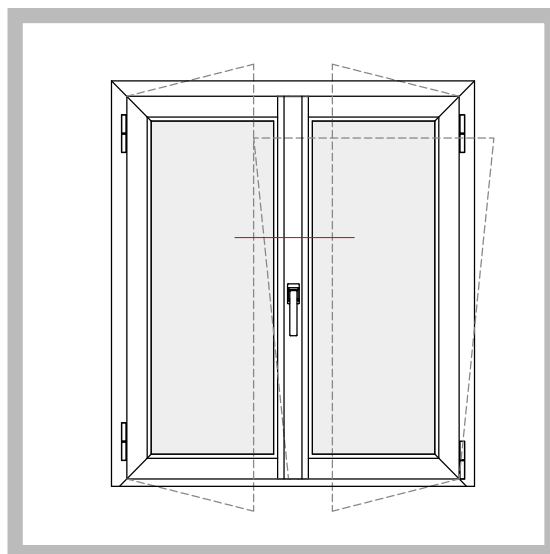



**FINESTRA A DUE ANTE**  
**Anta MX753.201**  
DOUBLE SASH WINDOW

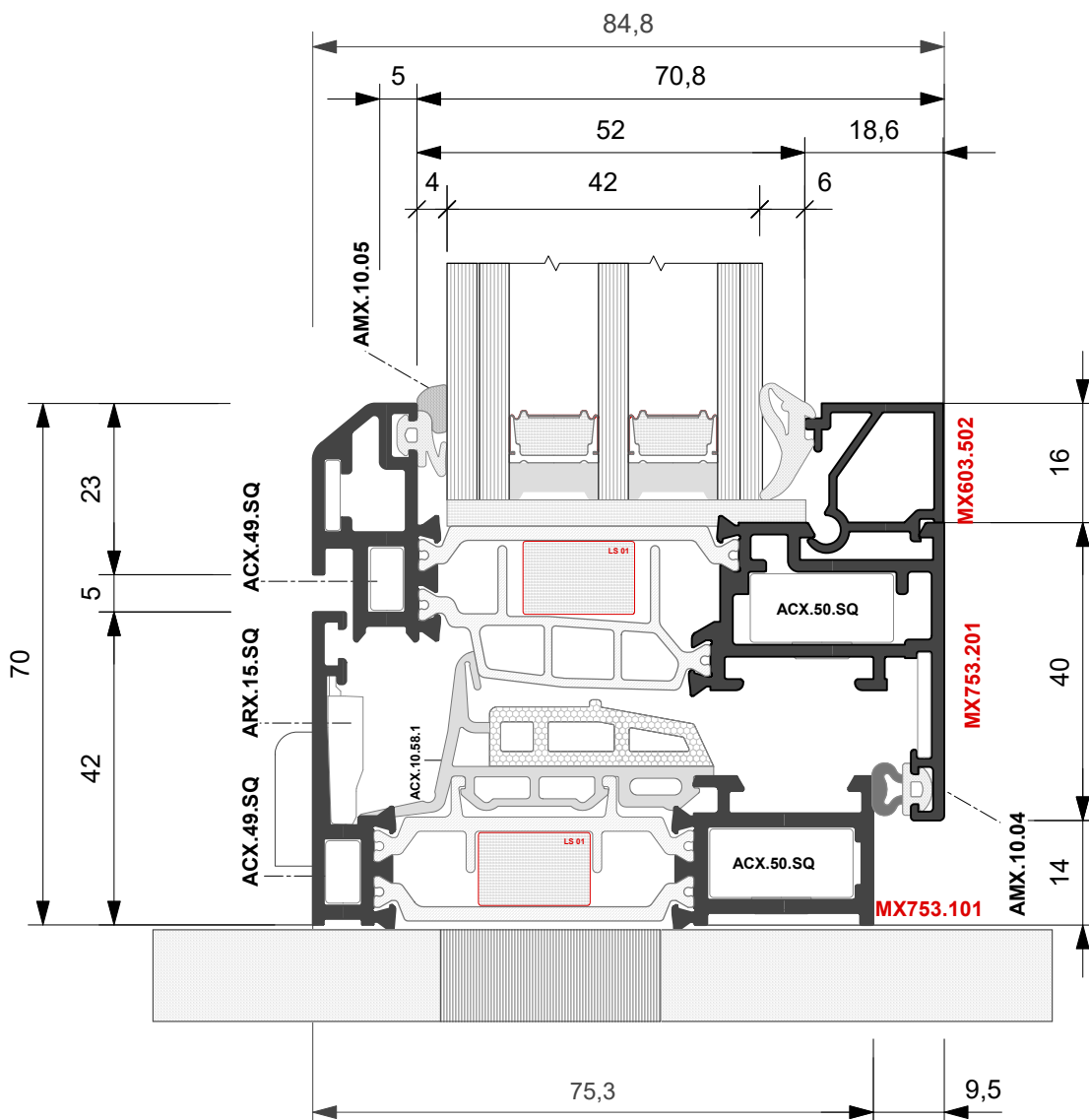
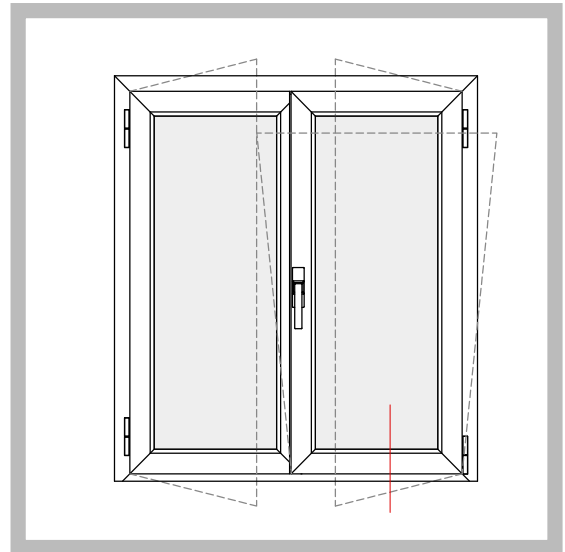



**PORTA BALCONE A DUE ANTE**  
**Anta MX753.201**  
*DOUBLE SASH BALCONY DOOR*

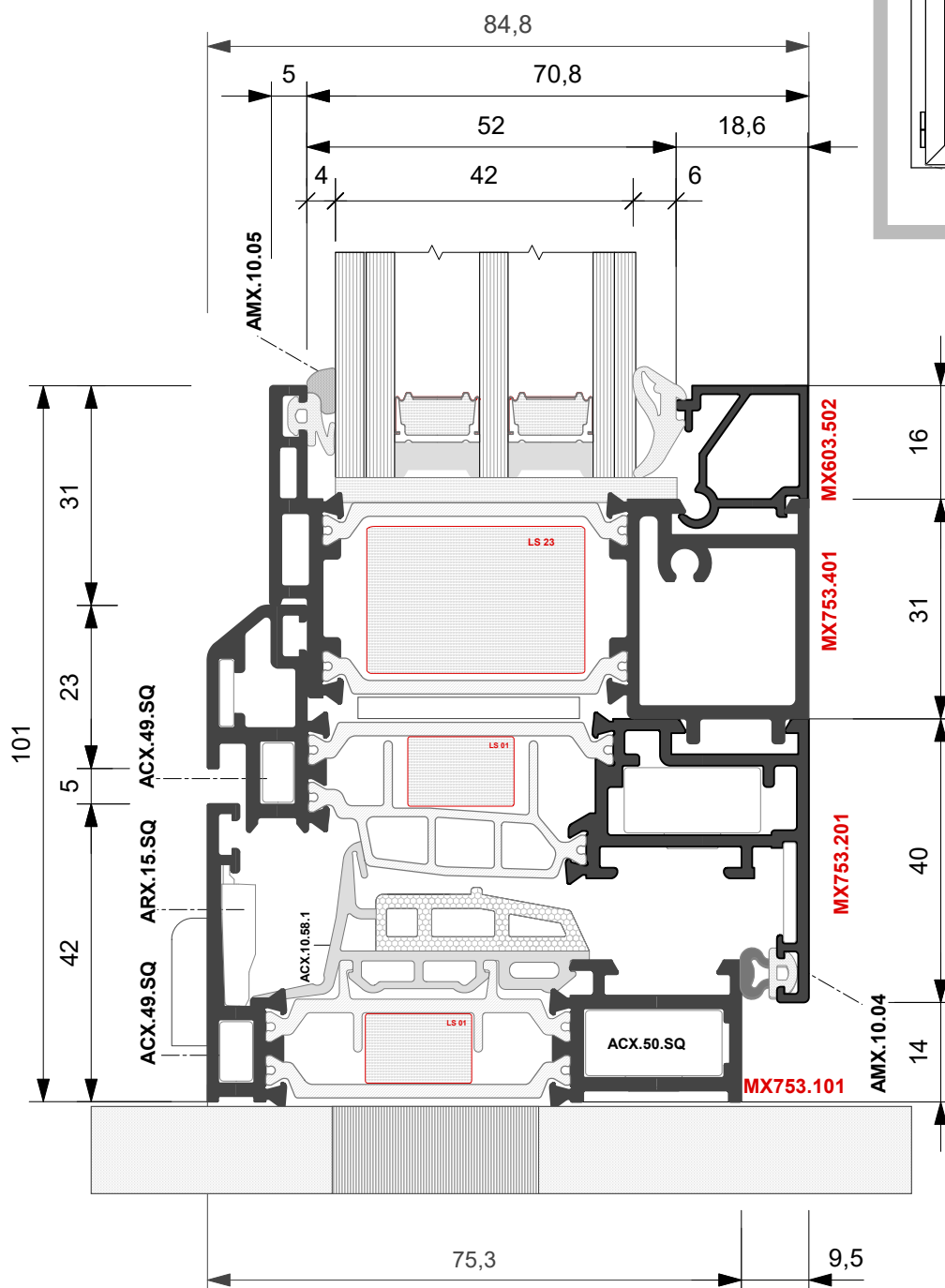
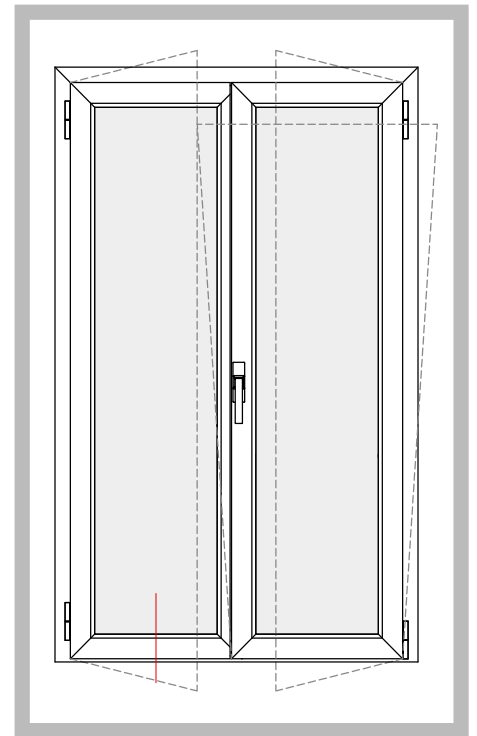



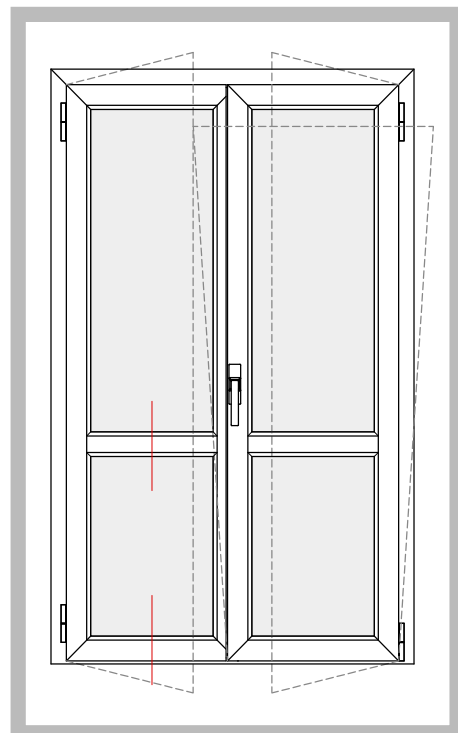
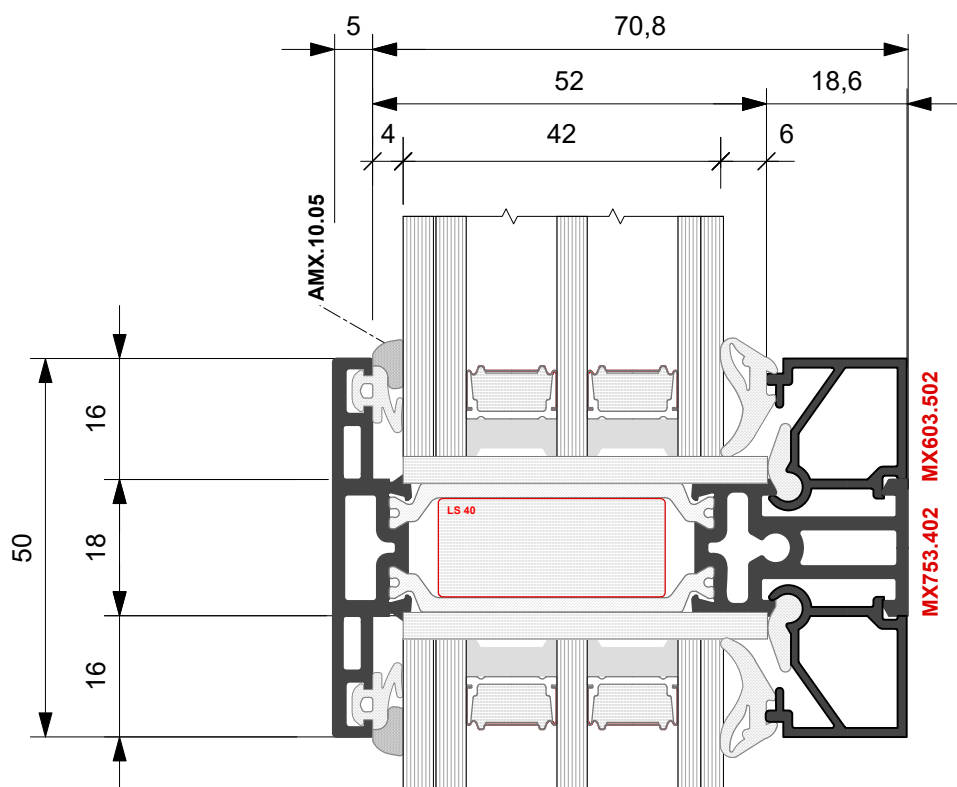

**PORTA BALCONE A DUE ANTE**  
**Anta MX753.201**  
*DOUBLE SASH BALCONY DOOR*

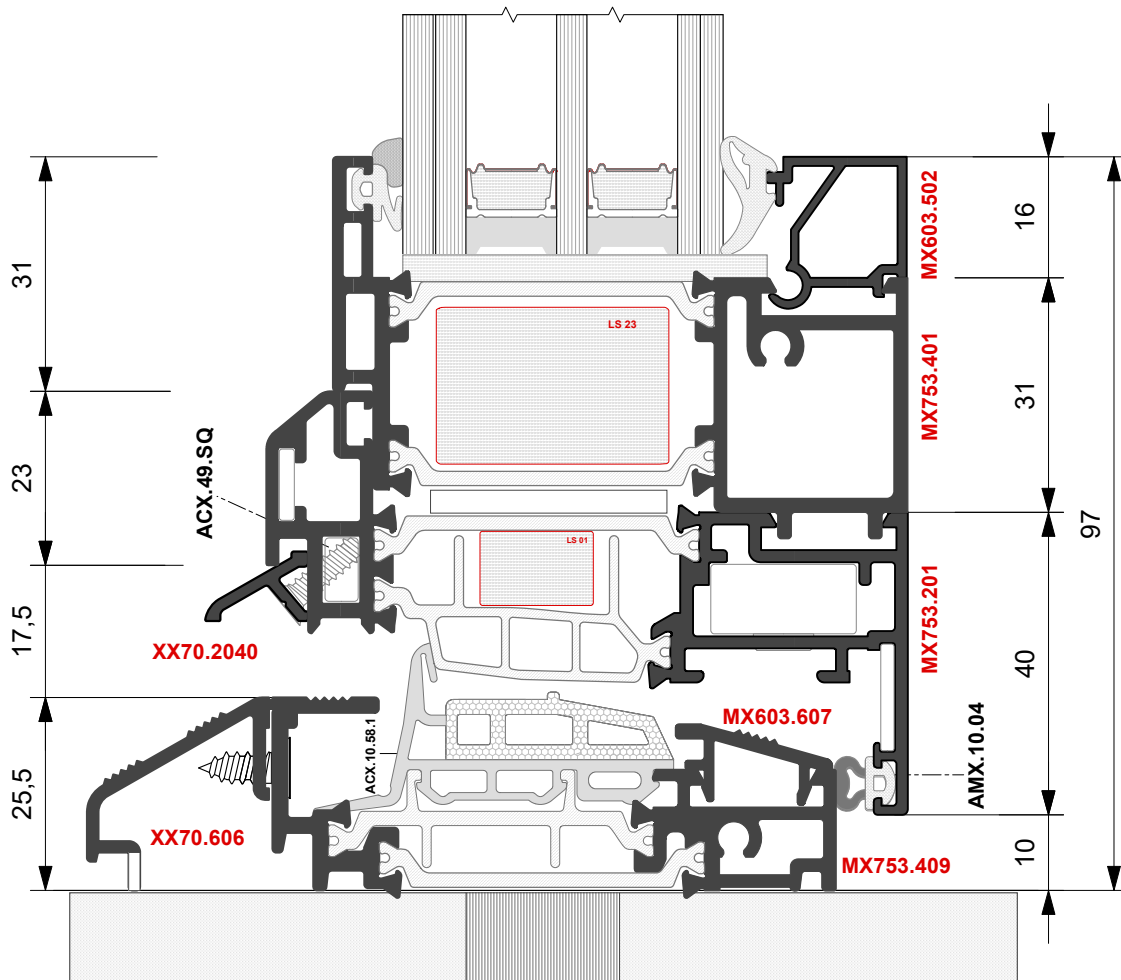



**FINESTRA A DUE ANTE CON FISSO**

**Anta MX753.235**

*DOUBLE SASH WINDOW  
with fixed frame*

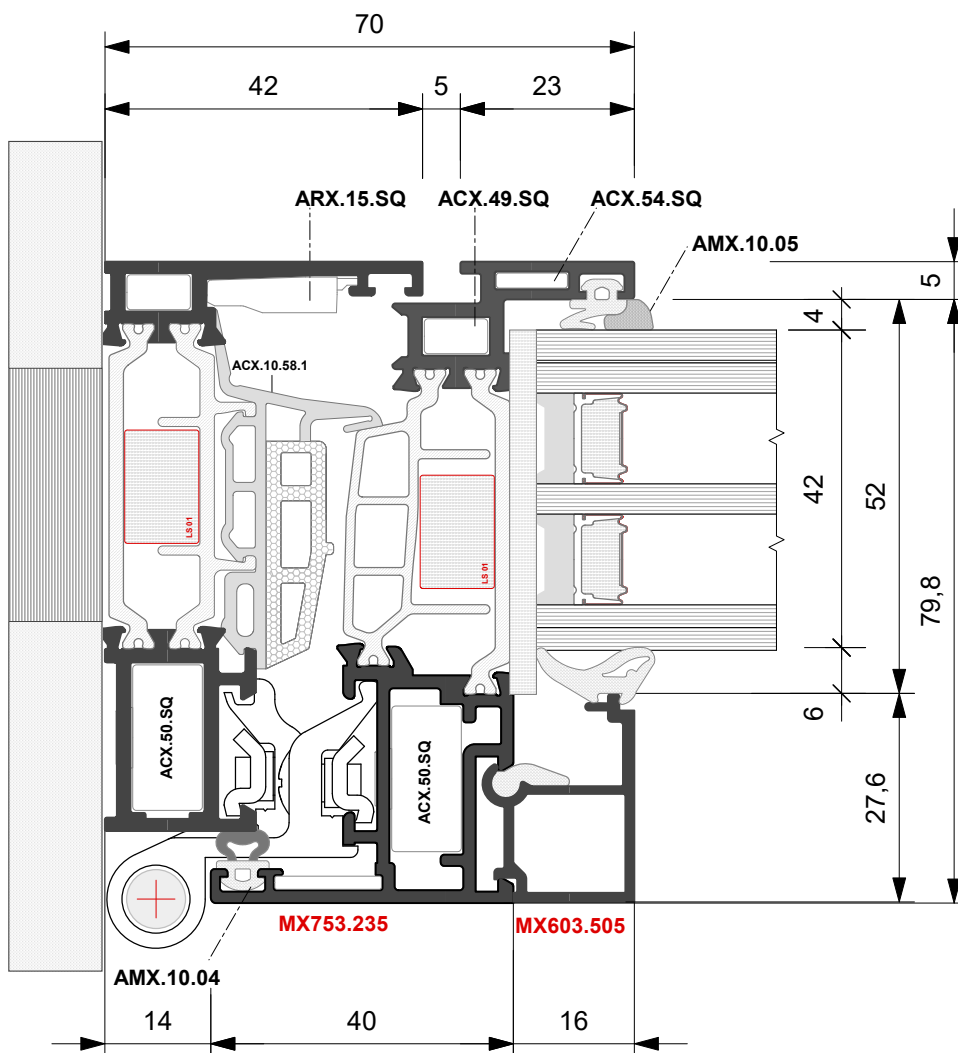
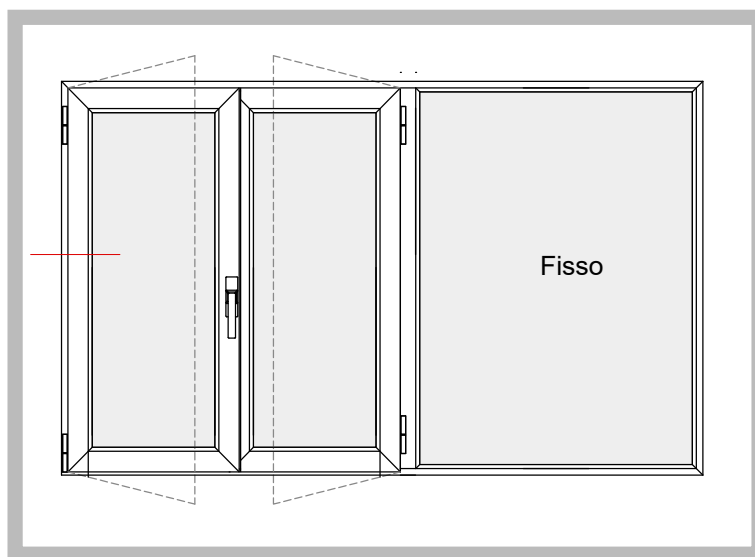



**FINESTRA A DUE ANTE CON FISSO**

**Anta MX753.235**

*DOUBLE SASH WINDOW  
with fixed frame*

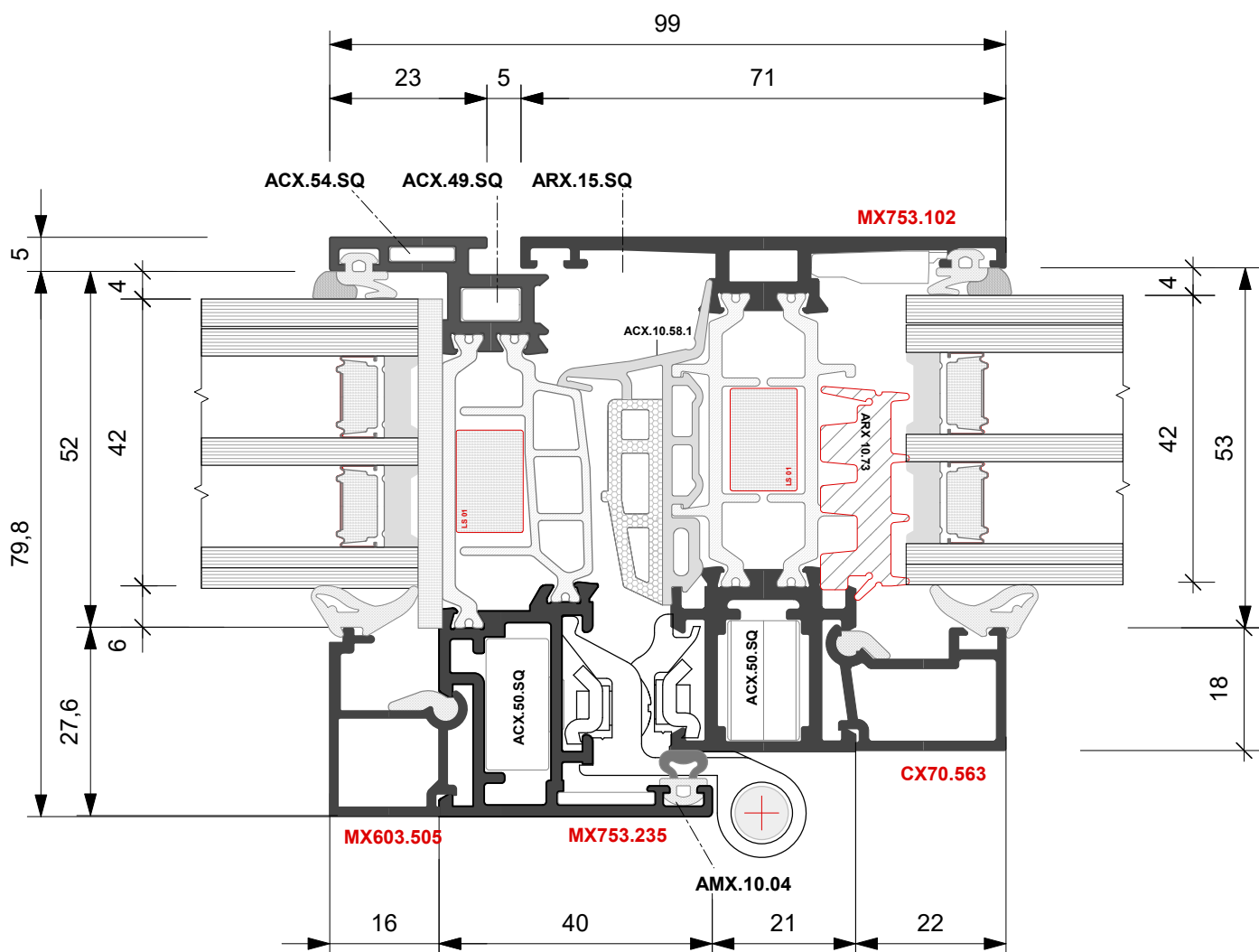
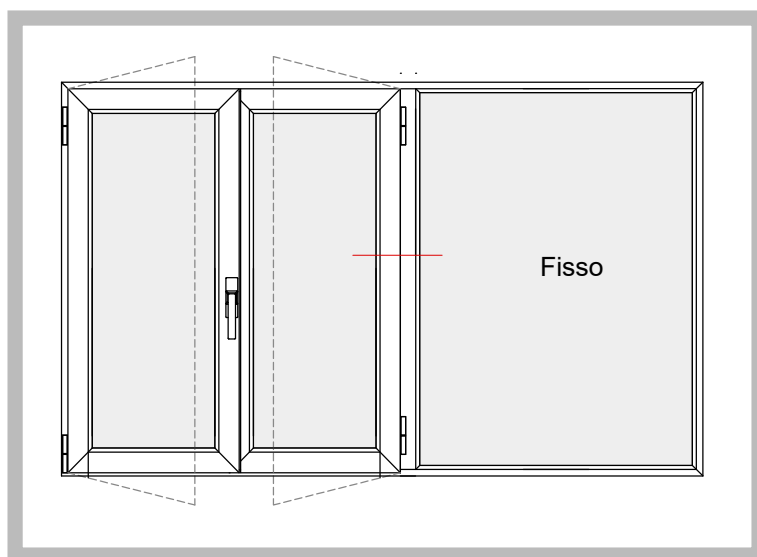



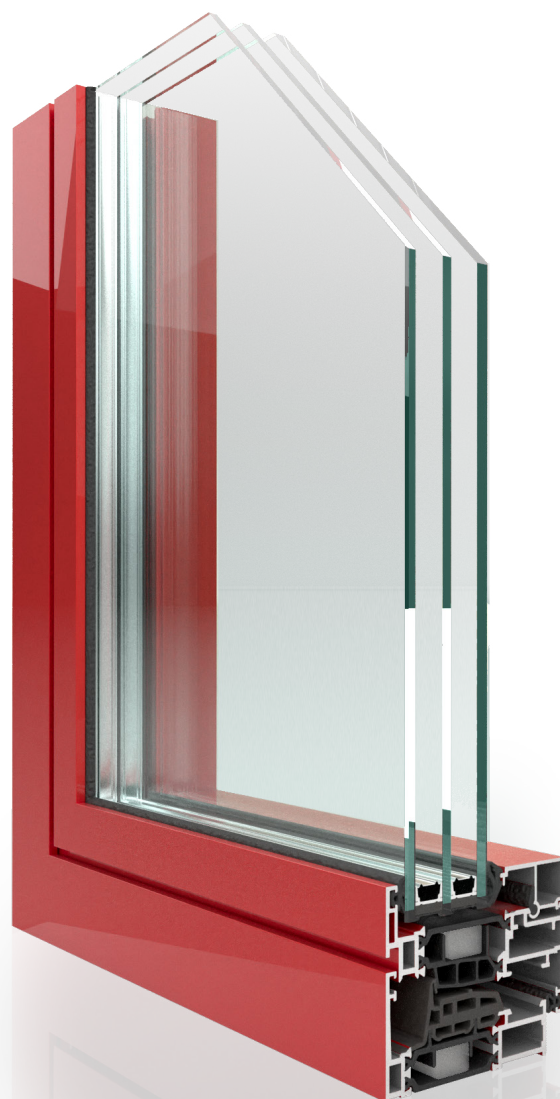

Tipologie  
*Types*

Gruppo **E**

Tipologie  *Main Sections*





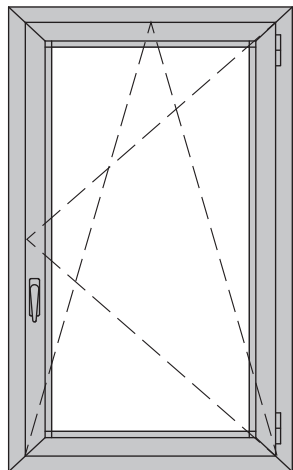

■ Finestra 1 Anta **[MX753.235]**  
1 Sash Window

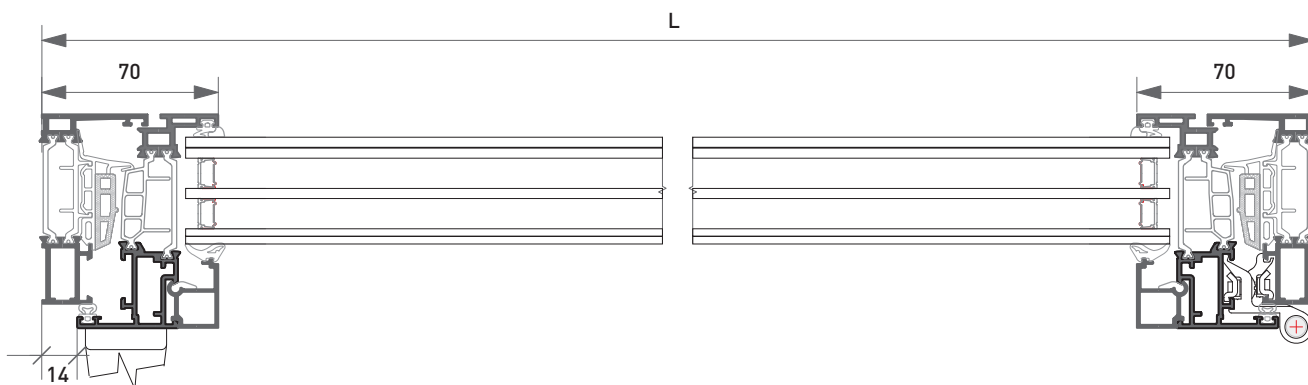
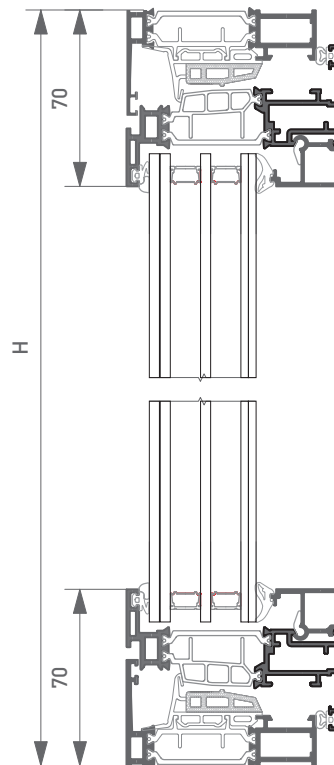
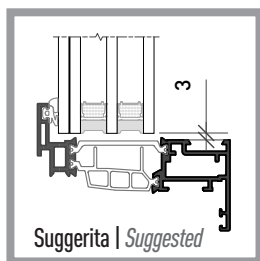

| DISTINTA Taglio Vetri   Glass Cutting List |              |              |
|--|--------------|--------------|
| Qt.  | H            | L            |
| <b>1</b>                                   | <b>H-114</b> | <b>L-114</b> |
| <b>Spazio/Gap 3 mm.</b>                    |              |              |







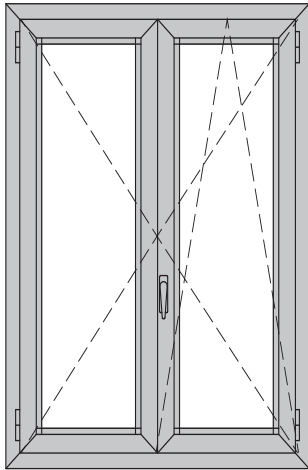

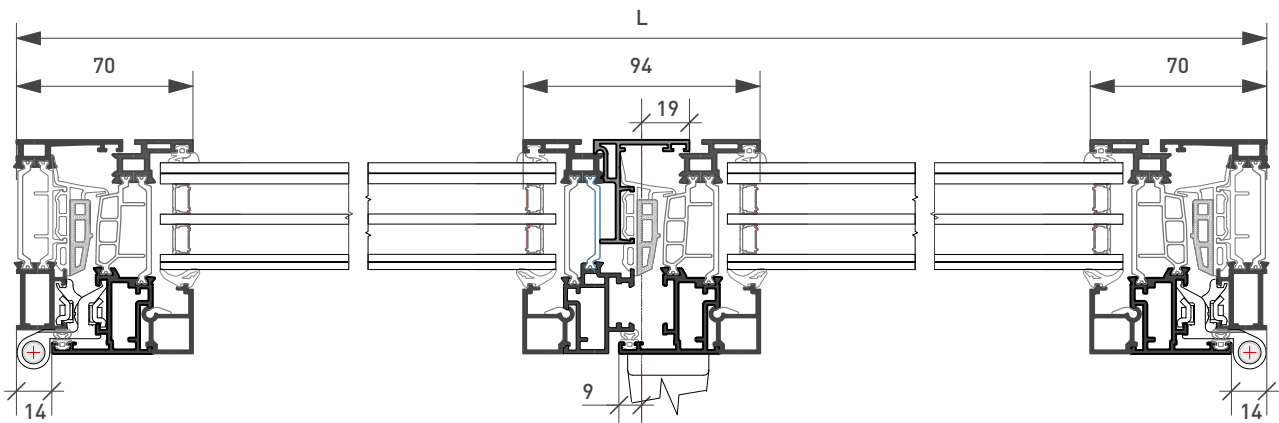
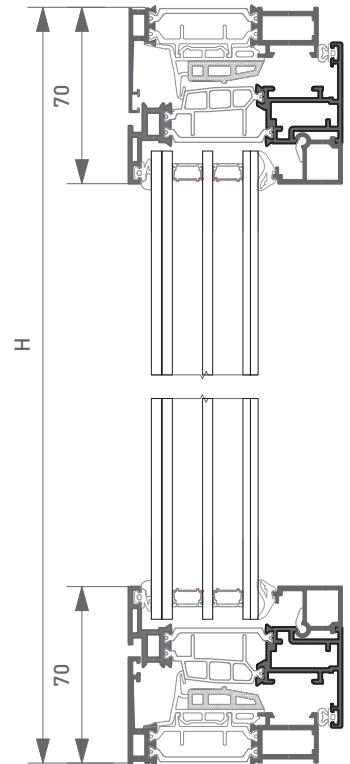
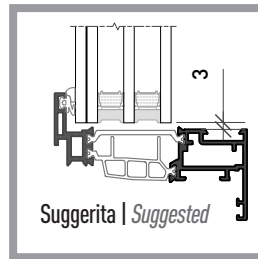

| Profilo<br>Profile   | Taglio<br>CUT | Qt.      | Profilo<br>Profile   | Taglio<br>CUT  | Qt.      |
|--|---------------|----------|--|----------------|----------|
| MX753.101<br> | <b>L</b>      | <b>2</b> | MX603.505<br> | <b>L - 108</b> | <b>2</b> |
|  | <b>H</b>      | <b>2</b> |  | <b>H - 140</b> | <b>2</b> |
| MX753.235<br> | <b>L - 28</b> | <b>2</b> | CX70.605<br>  |                |          |
|  | <b>H - 28</b> | <b>2</b> |  |                |          |

■ Finestra 2 Ante **[MX753.235]**  
2 Sashes Window



| <b>DISTINTA Taglio Vetri   Glass Cutting List</b> |              |               |
|---|--------------|---------------|
| Qt.   | H            | L             |
| <b>2</b>  | <b>H-114</b> | <b>L/2-91</b> |
| <b>Spazio/Gap 3 mm.</b>                           |              |               |



| Profilo<br>Profile   | Taglio<br>CUT  | Qt.      | Profilo<br>Profile   | Taglio<br>CUT   | Qt.      | Profilo<br>Profile   | Taglio<br>CUT   | Qt.      |
|--|----------------|----------|--|-----------------|----------|--|---|----------|
| MX753.101<br> | <b>L</b>       | <b>2</b> | MX603.505<br> | <b>L/2 - 85</b> | <b>4</b> | CX 70.605<br> |  |          |
|  | <b>H</b>       | <b>2</b> |  | <b>H - 140</b>  | <b>4</b> |  |   |          |
| MX753.235<br> | <b>L/2 - 5</b> | <b>4</b> | MX753.305<br> | <b>H - 52</b>   | <b>1</b> | MX753.304<br> | <b>H - 94</b>   | <b>1</b> |
|  | <b>H - 28</b>  | <b>3</b> |  |                 |          |  |   |          |





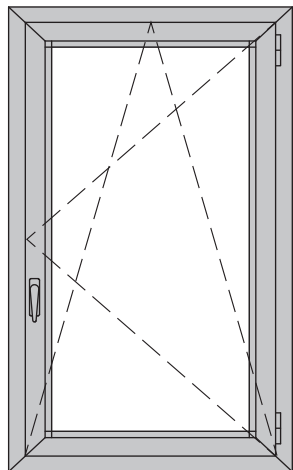

■ Finestra 1 Anta **[MX753.201]**  
1 Sash Window

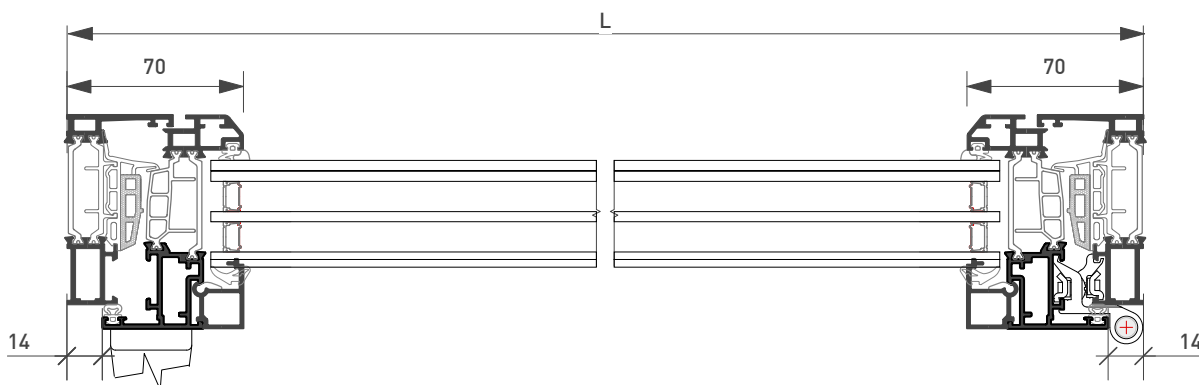
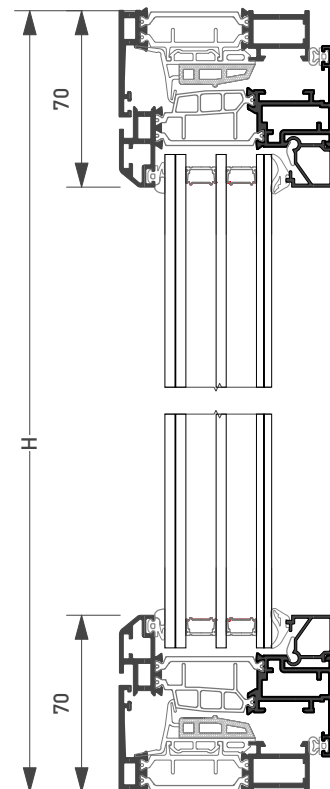
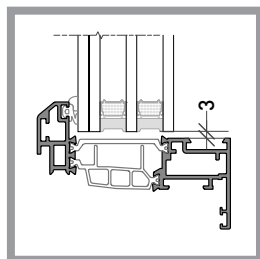

| DISTINTA Taglio Vetri   Glass Cutting List |              |              |
|--|--------------|--------------|
| Qt.  | H            | L            |
| <b>1</b>                                   | <b>H-114</b> | <b>L-114</b> |
| <b>Spazio/Gap 3 mm.</b>                    |              |              |







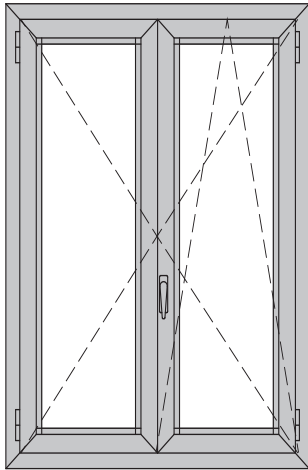

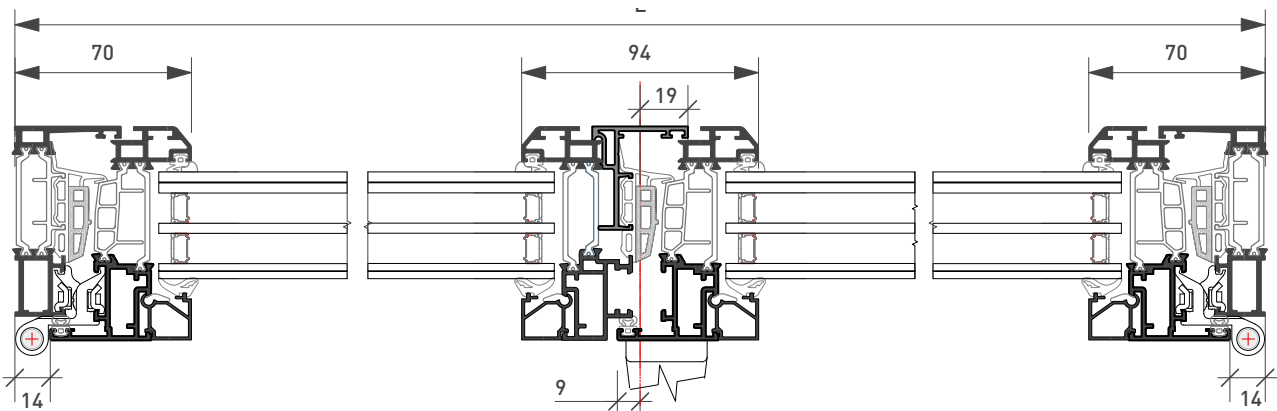
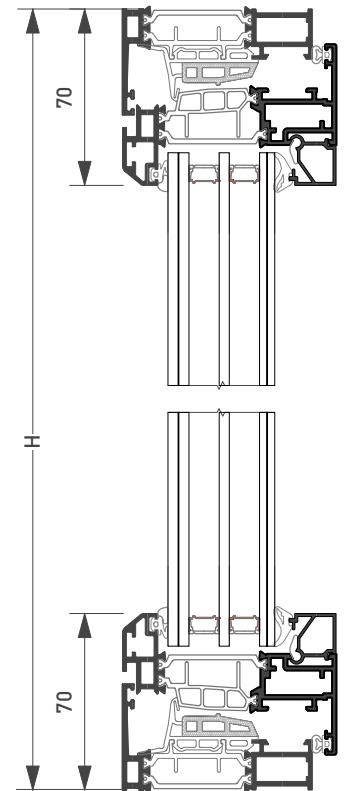
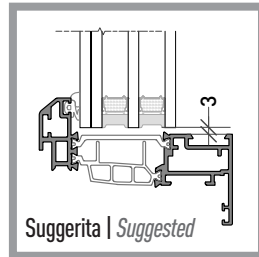

| Profilo<br>Profile  | Taglio<br>CUT | Qt.      | Profilo<br>Profile  | Taglio<br>CUT  | Qt.      |
|---|---------------|----------|---|----------------|----------|
| <b>MX753.101</b><br> | <b>L</b>      | <b>2</b> | <b>MX603.502</b><br> | <b>L - 108</b> | <b>2</b> |
|   | <b>H</b>      | <b>2</b> |   | <b>H - 140</b> | <b>2</b> |
| <b>MX753.201</b><br> | <b>L - 28</b> | <b>2</b> | <b>CX70.605</b><br>  |                |          |
|   | <b>H - 28</b> | <b>2</b> |   |                |          |

■ Finestra 2 Ante **[MX753.201]**  
2 Sashes Window



| DISTINTA Taglio Vetri   Glass Cutting List |              |               |
|--|--------------|---------------|
| Qt.  | H            | L             |
| <b>2</b>                                   | <b>H-114</b> | <b>L/2-91</b> |
| <b>Spazio/Gap 3 mm.</b>                    |              |               |



| Profilo<br>Profile   | Taglio<br>CUT  | Qt.      | Profilo<br>Profile   | Taglio<br>CUT   | Qt.      | Profilo<br>Profile   | Taglio<br>CUT   | Qt.      |
|--|----------------|----------|--|-----------------|----------|--|---|----------|
| MX753.101<br> | <b>L</b>       | <b>2</b> | MX603.502<br> | <b>L/2 - 85</b> | <b>4</b> | CX70.605<br>  |  |          |
|  | <b>H</b>       | <b>2</b> |  | <b>H - 140</b>  | <b>4</b> |  |   |          |
| MX753.201<br> | <b>L/2 - 5</b> | <b>4</b> | MX753.301<br> | <b>H - 52</b>   | <b>1</b> | MX753.304<br> | <b>H - 94</b>   | <b>1</b> |
|  | <b>H - 28</b>  | <b>3</b> |  |                 |          |  |   |          |



■ Finestra 1 Anta **[MX753.202]**  
1 Sash Window

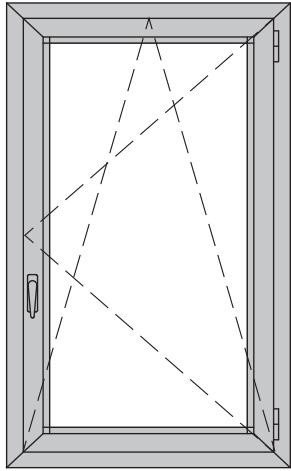

| DISTINTA Taglio Vetri   Glass Cutting List |       |       |
|--|-------|-------|
| Qt.  | H     | L     |
| 1  | H-114 | L-114 |
| Spazio/Gap 3 mm.                           |       |       |

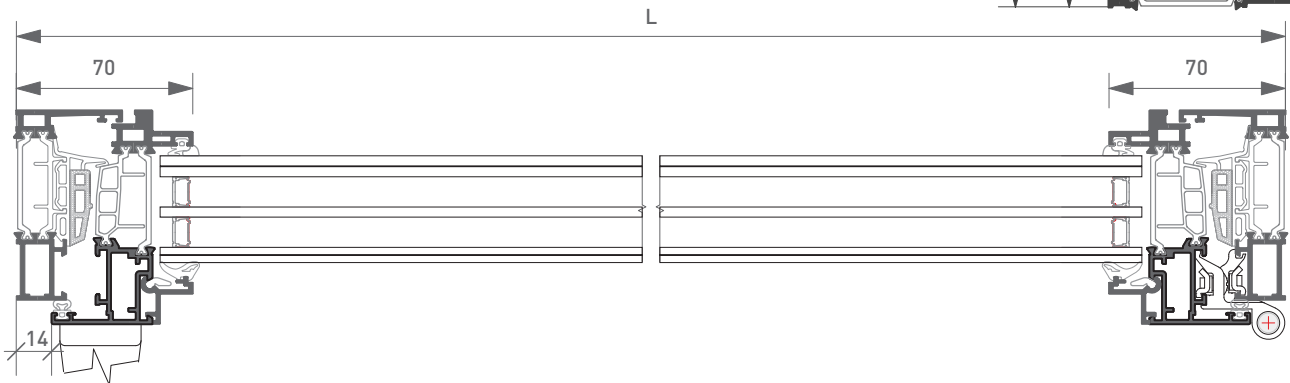
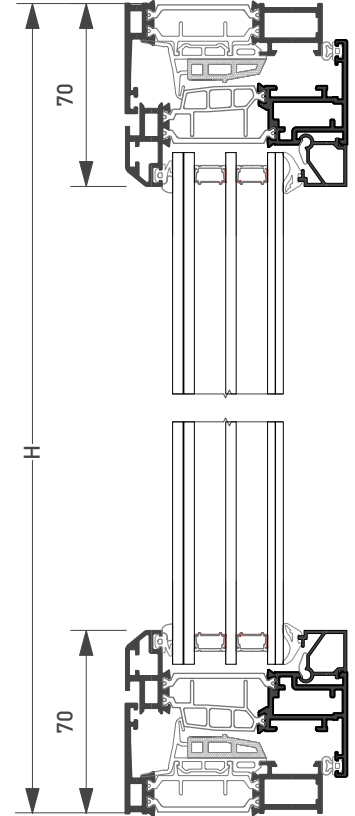
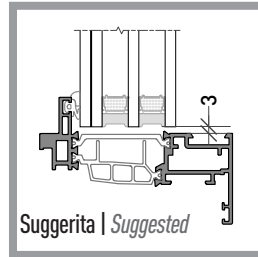

| Profilo<br>Profile | Taglio<br>CUT | Qt. | Profilo<br>Profile | Taglio<br>CUT | Qt. |
|--------------------|---------------|-----|--------------------|---------------|-----|
| MX753.101<br>      | L             | 2   | MX603.505<br>      | L - 108       | 2   |
|                    | H             | 2   |                    | H - 115       | 2   |
| MX753.235<br>      | L - 28        | 2   | CX70.605<br>       |               |     |
|                    | H - 28        | 2   |                    |               |     |



■ Finestra 2 Ante **[MX753.202]**  
2 Sashes Window

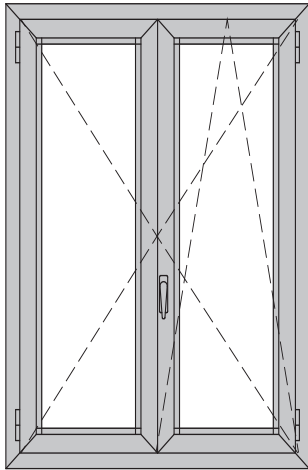

| <b>DISTINTA</b> Taglio Vetri   <i>Glass Cutting List</i> |              |               |
|--|--------------|---------------|
| Qt.  | H            | L             |
| <b>2</b>   | <b>H-114</b> | <b>L/2-91</b> |
| <b>Spazio/Gap 3 mm.</b>                                  |              |               |

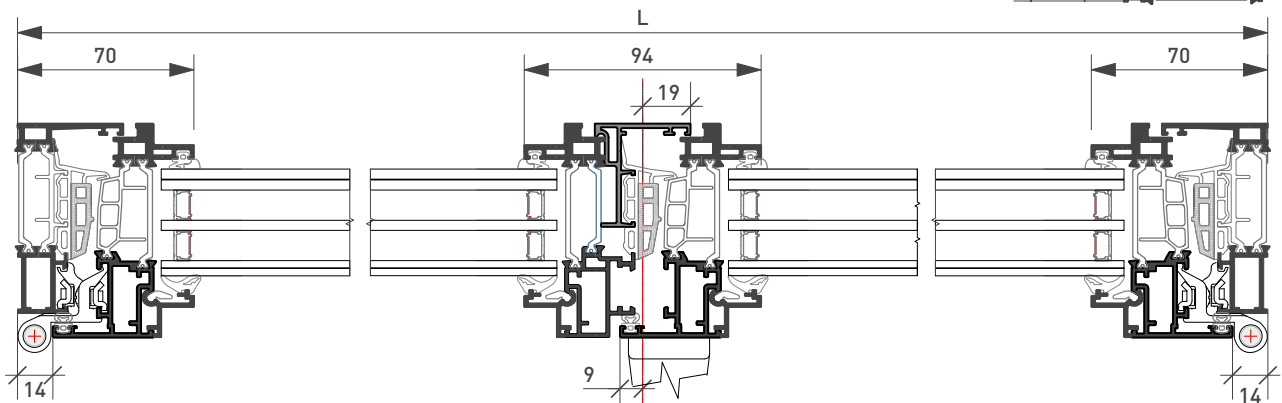
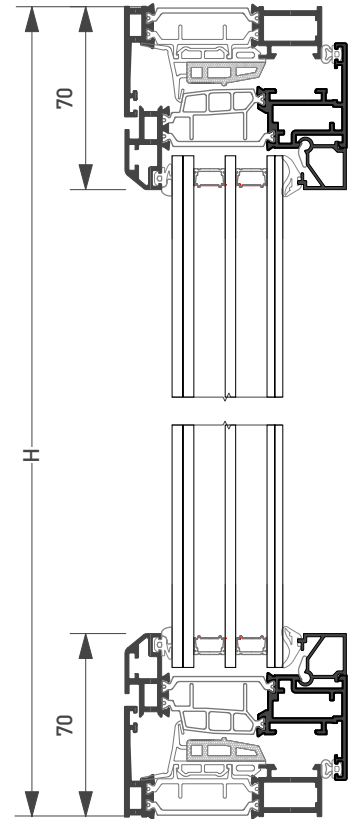
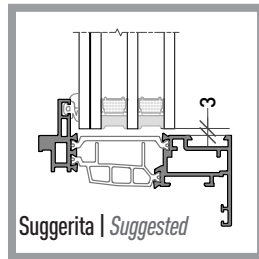

| Profilo<br>Profile | Taglio<br>CUT  | Qt.      | Profilo<br>Profile | Taglio<br>CUT   | Qt.      | Profilo<br>Profile | Taglio<br>CUT | Qt.      |
|--------------------|----------------|----------|--------------------|-----------------|----------|--------------------|---------------|----------|
| MX753.101<br>      | <b>L</b>       | <b>2</b> | MX603.507<br>      | <b>L/2 - 85</b> | <b>4</b> | CX 70.605<br>      |               |          |
|                    | <b>H</b>       | <b>2</b> |                    | <b>H - 115</b>  | <b>4</b> |                    |               |          |
| MX753.202<br>      | <b>L/2 - 5</b> | <b>4</b> | MX753.302<br>      | <b>H - 52</b>   | <b>1</b> | MX753.304<br>      | <b>H - 94</b> | <b>1</b> |
|                    | <b>H - 28</b>  | <b>3</b> |                    |                 |          |                    |               |          |



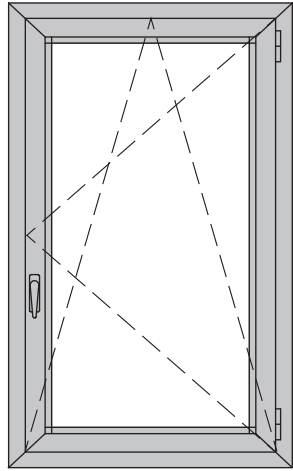

■ Finestra 1 Anta **[MX753.204]**  
1 Sash Window

**FERRAMENTA A NASTRO**  
TAPE HARDWARE

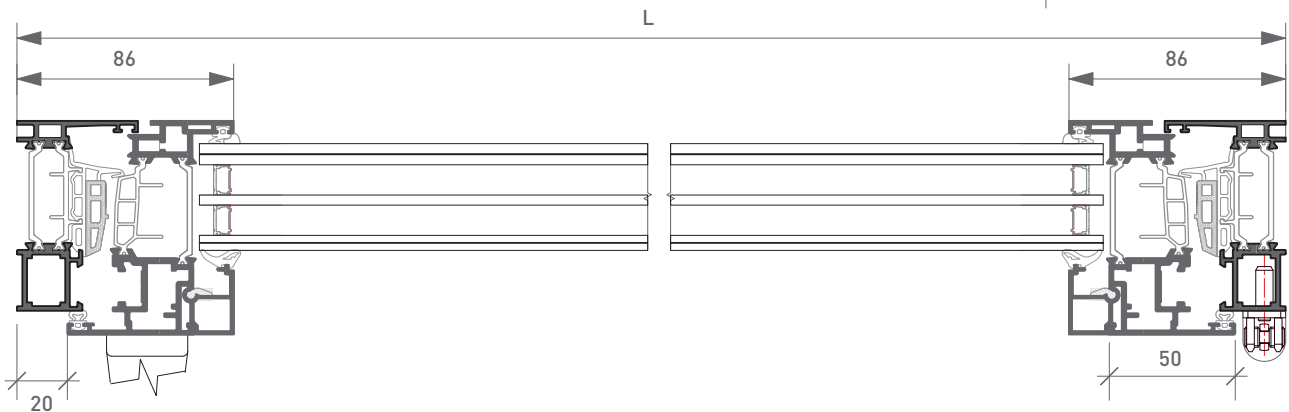
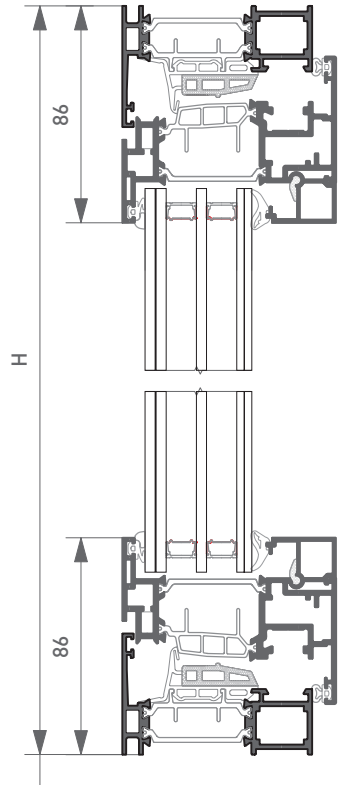
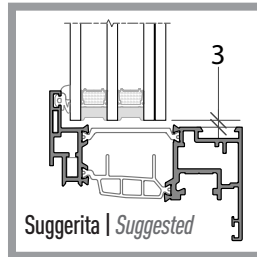

| DISTINTA Taglio Vetri   Glass Cutting List |              |              |
|--|--------------|--------------|
| Qt.  | H            | L            |
| <b>1</b>                                   | <b>H-146</b> | <b>L-146</b> |
| <b>Spazio/Gap 3 mm.</b>                    |              |              |



| Profilo<br>Profile   | Taglio<br>CUT | Qt.      | Profilo<br>Profile   | Taglio<br>CUT  | Qt.      |
|--|---------------|----------|--|----------------|----------|
| MX753.104<br> | <b>L</b>      | <b>2</b> | MX603.505<br> | <b>L - 140</b> | <b>2</b> |
|  | <b>H</b>      | <b>2</b> |  | <b>H - 172</b> | <b>2</b> |
| MX753.204<br> | <b>L - 40</b> | <b>2</b> | CX70.605<br>  |                |          |
|  | <b>H - 40</b> | <b>2</b> |  |                |          |

■ Finestra 2 Ante **[MX753.204]**  
2 Sashes Window

**FERRAMENTA A NASTRO**  
TAPE HARDWARE

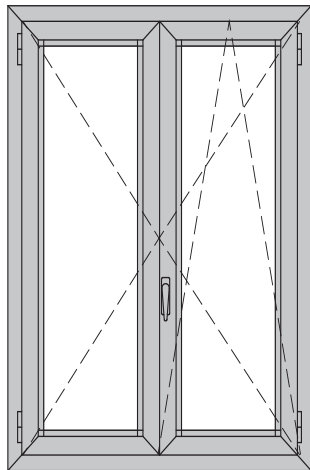

| <b>DISTINTA Taglio Vetri   Glass Cutting List</b> |              |                |
|---|--------------|----------------|
| Qt.   | H            | L              |
| <b>2</b>  | <b>H-146</b> | <b>L/2-117</b> |
| <b>Spazio/Gap 3 mm.</b>                           |              |                |

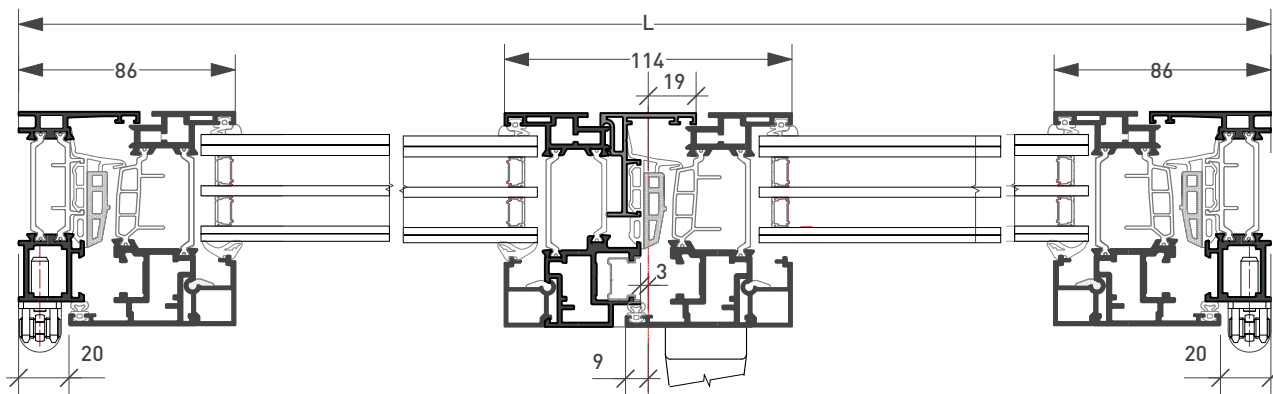
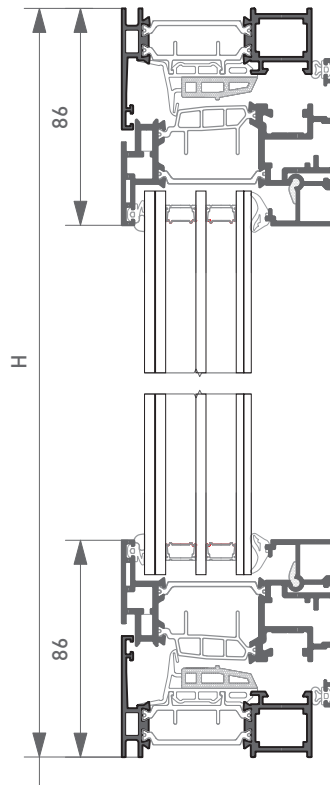
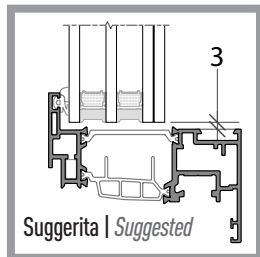

| Profilo<br>Profile | Taglio<br>CUT | Qt.      | Profilo<br>Profile | Taglio<br>CUT | Qt.      | Profilo<br>Profile | Taglio<br>CUT | Qt.      |
|--------------------|---------------|----------|--------------------|---------------|----------|--------------------|---------------|----------|
| MX753.104<br>      |               | <b>2</b> | MX603.507<br>      |               | <b>4</b> | CX 70.605<br>      |               |          |
|                    |               | <b>2</b> |                    |               | <b>4</b> |                    |               |          |
| MX753.204<br>      |               | <b>4</b> | MX753.308<br>      |               | <b>1</b> | MX753.304<br>      |               | <b>1</b> |
|                    |               | <b>3</b> |                    |               |          |                    |               |          |

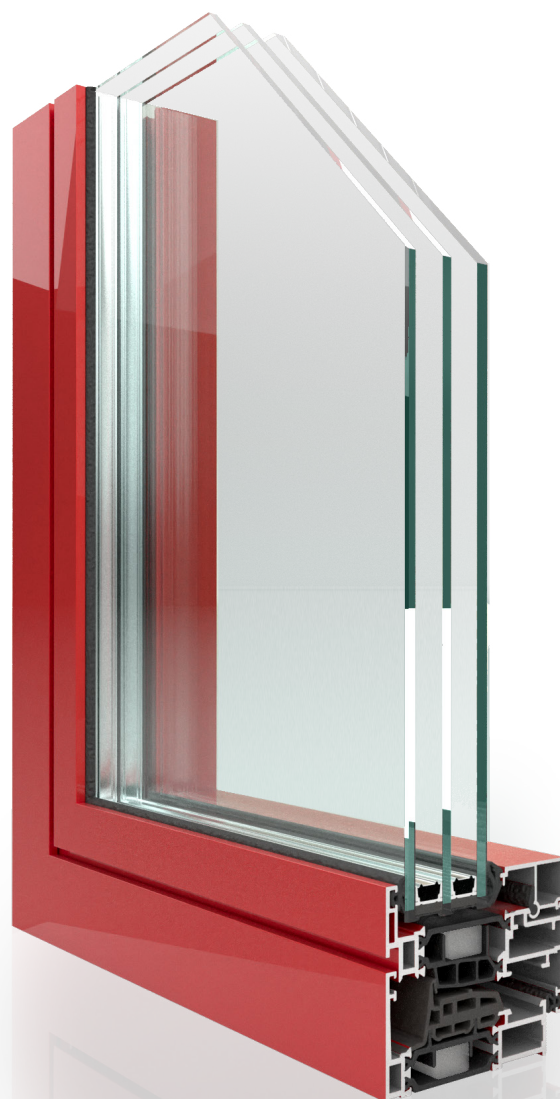

**Attacco alla Muratura**  
*Connection to Brickwork*

**Gruppo F**

Sezione particolareggiata  
attacco alla muratura

*Wall Joint Detail*







**SCHEMA FISSAGGIO** | *Fixing*

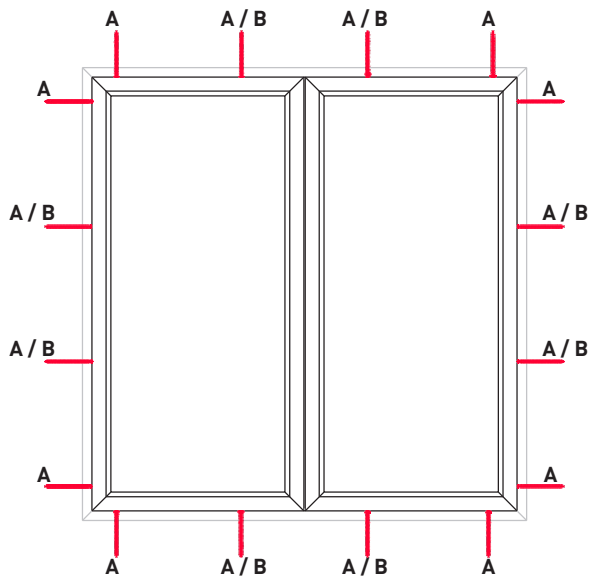

▶ **A= DAGLI ANGOLI** | *From the CORNERS = 150 mm.*

▶ **A/B= INTERASSE** | *Center Distance = 700 mm.*

▶ **FISSAGGI MINIMI** | *Minimum Fasteners = 8 Fasteners*

**Verticale = 3 Fissaggi /Lato** | *Vertical = 3 Fasteners/Side*

**Orizzontale = 1 Fissaggio/Lato** | *Horizontal = Fasteners/Side*

**Tipo A** | *Type A*

**ARX.06.02**  
 Piastrina Registro  
 Universale

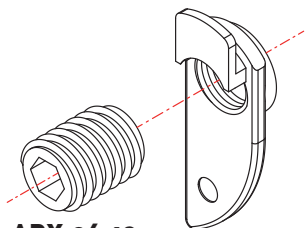

**ARX.06.12**  
 GRANO per Registro Telaio  
 Dim= 12 mm.

- Registro Telaio  
**TWIN SYSTEMS**
- ▶ **TWIN SYSTEMS**  
*Frame adjustment register*

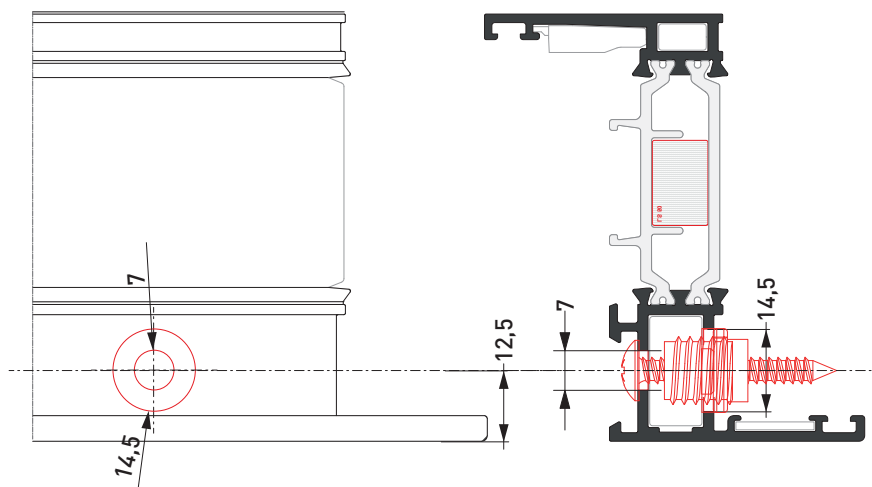

**Tipo B** | *Type B*

**UNI6954-DIN7981/ISO7049**

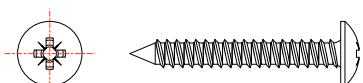

- Vite Autofilettante a Testa Bombata. Impronta a Croce
- ▶ *Autodrilling Phillips Rounded Head Screw*

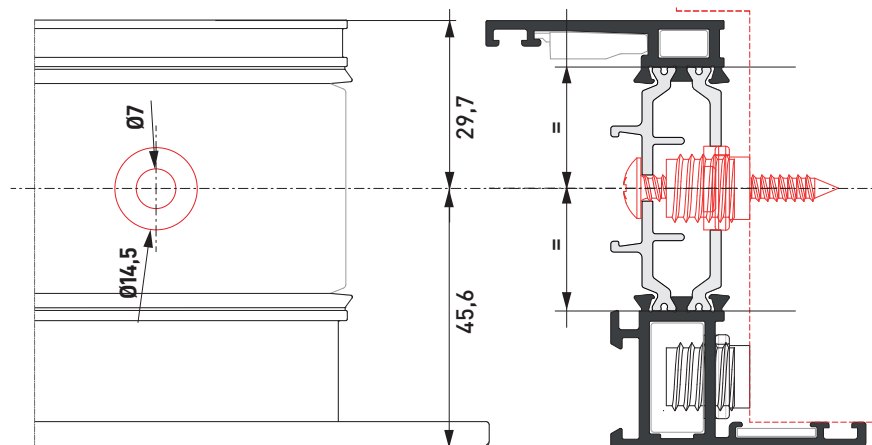



**POSA QUALITÀ**

■ SEZIONE ORIZZONTALE

► HORIZONTAL SECTION

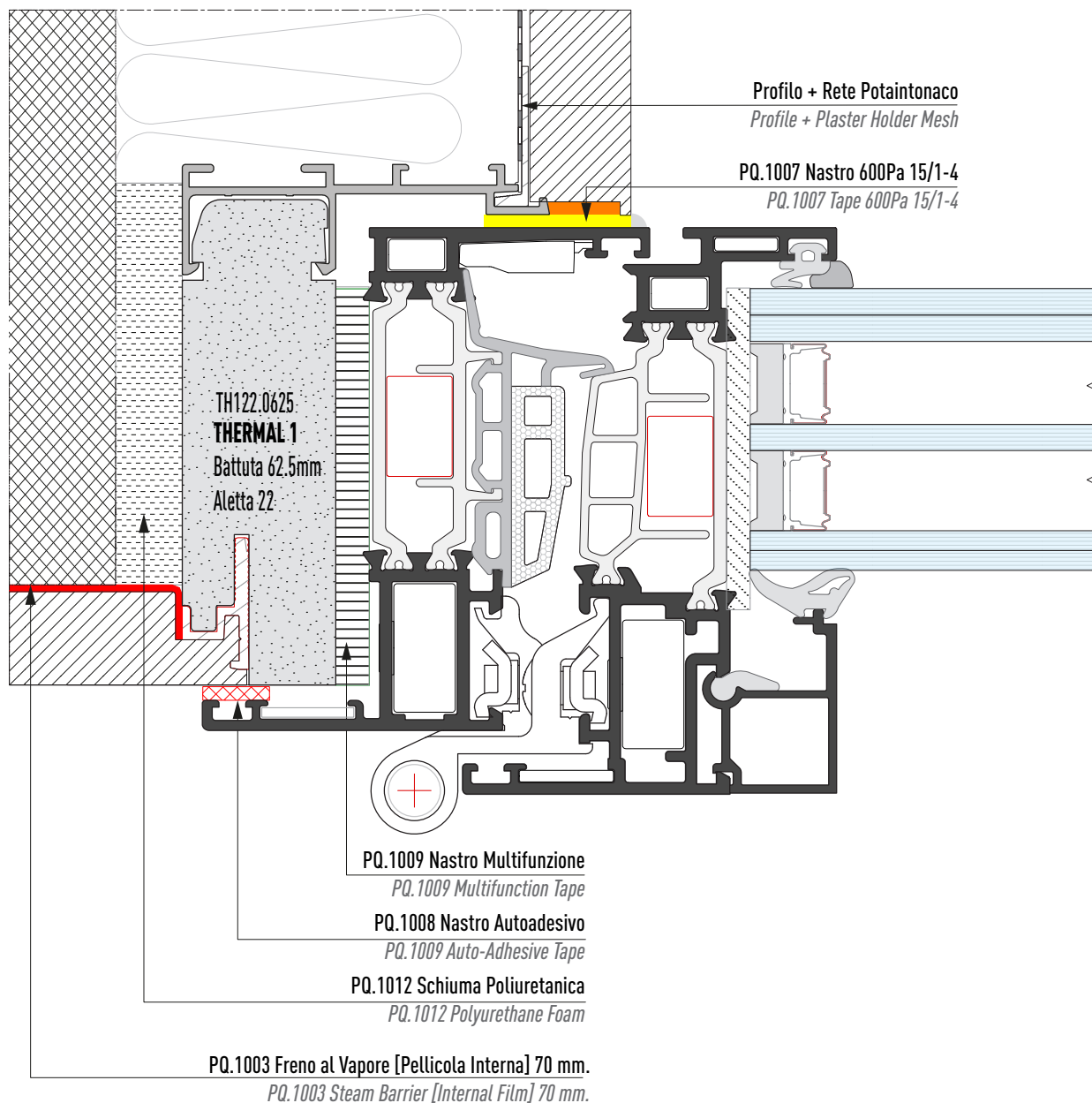

■ LEGENDA MATERIALI



**Muratura**  
*Brickwall*

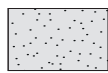

**Controtelaio THERMAL**  
*Wall frame THERMAL*



**PQ.1012 Schiuma Poliuretanic**  
*PQ.1012 Polyurethane Foam*



**Intonaco**  
*Plaster*

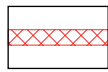

**PQ.1008 Nastro Autoadesivo 9x2**  
*PQ.1008 Auto-Adhesive Tape 9x2*



**PQ.1003 Freno al Vapore [Pellicola Interna] 70 mm.**  
*PQ.1003 Steam Barrier [Internal Film] 70 mm.*



**Isolamento**  
*Insulation*

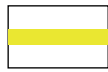

**PQ.1007 Nastro 600Pa 15/1-4**  
*PQ.1007 Tape 600Pa 15/1-4*



**Sigillante Ibrido**  
*Hybrid Sealant*







**POSA QUALITÀ**

■ SEZIONE VERTICALE

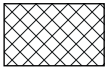
► VERTICAL SECTION

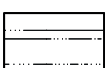
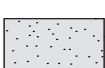
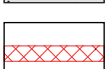
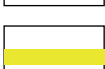
■ LEGENDA MATERIALI

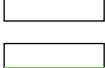
-  **Muratura**  
*Brickwall*
-  **Intonaco**  
*Plaster*
-  **Soglia**  
*Threshold*
-  **Controtelaio THERMAL**  
*Wall frame THERMAL*
-  **PQ.1008 Nastro Autoadesivo 9x2**  
*PQ.1008 Auto-Adhesive Tape 9x2*
-  **PQ.1007 Nastro 600Pa 15/1-4**  
*PQ.1007 Tape 600Pa 15/1-4*
-  **PQ.1012 Schiuma Poliuretanic**  
*PQ.1012 Polyurethane Foam*
-  **PQ.1003 Freno al Vapore [Pellicola Interna] 70 mm.**  
*PQ.1003 Steam Barrier [Internal Film] 70 mm.*
-  **PQ.1005 Guaina Esterna EPDM 80 mm.**  
*PQ.1003 External Sheath EPDM 80 mm.*

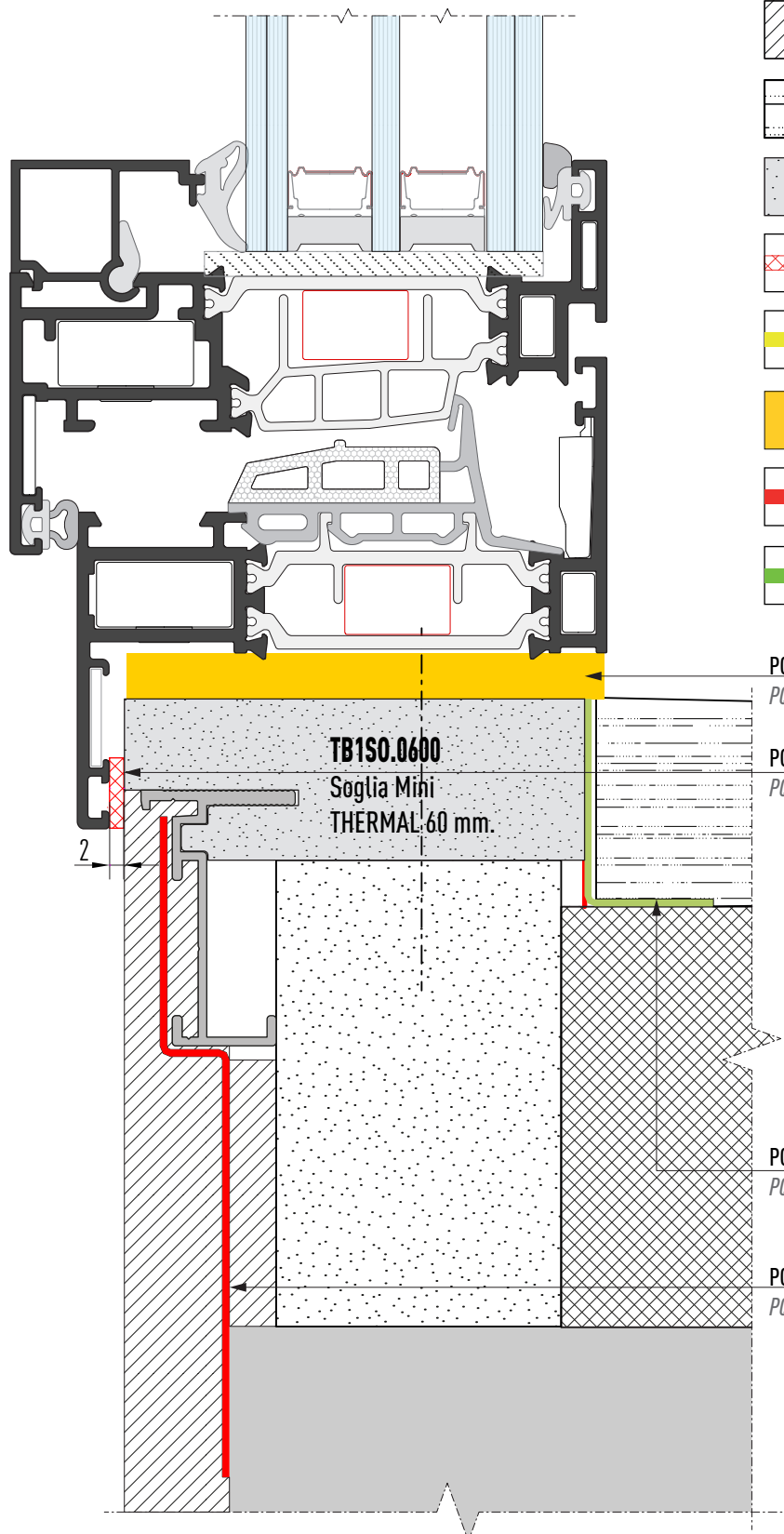

PQ.1010 Nastro PE 60x6 mm.  
*PQ.1010 Tape PE 60x6 mm.*

PQ.1008 Nastro PE 9x2 mm.  
*PQ.1008 Tape PE 9x2 mm.*

PQ.1005 Guaina Esterna EPDM 80 mm.  
*PQ.1003 External Sheath EPDM 80 mm.*

PQ.1003 Pellicola Interna 70 mm.  
*PQ.1003 Internal Film 70 mm.*





Lavorazioni e Montaggi  
*Tooling and Assembly*

Gruppo **G**

Schemi Lavorazioni  
Frese  
Attrezzatura

*Tooling Systems  
Cutters Equipments  
Milling*





■ **ASOLA SCARICO ACQUA**

► *WATER DRAINAGE SLOT*

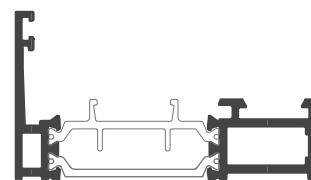
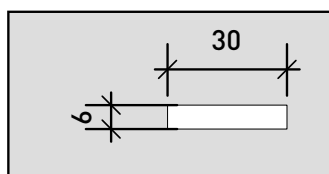
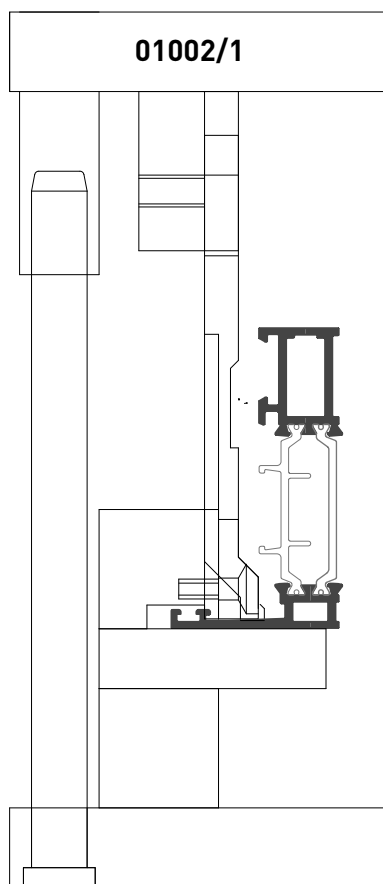



■ **FORO+ASOLA SQUADRETTE**  
**ACX50.SQ | ACX51.SQ**

► *HOLE+CORNER JOINT SLOT*  
**ACX50.SQ | ACX51.SQ**

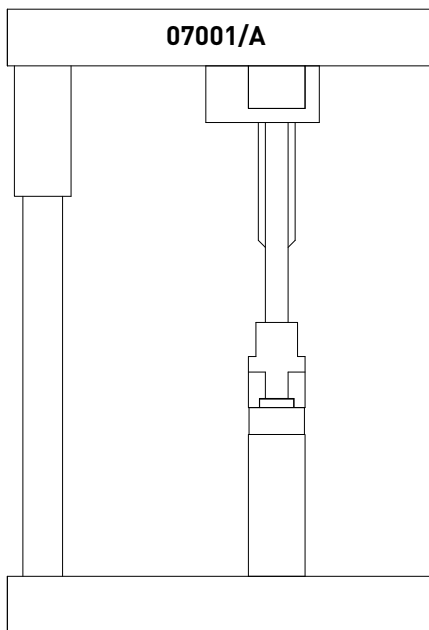

■ **CON GUIDA AGGIUNTIVA DEDICATA PER**  
**MX753.204 | MX753.308**

► *WITH ADDITIONAL GUIDE DEDICATED FOR*  
**MX753.204 | MX753.308**

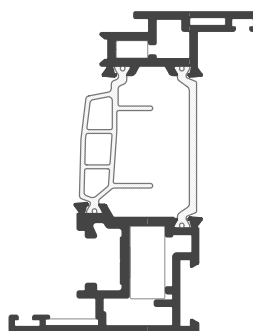

**MX753.204**

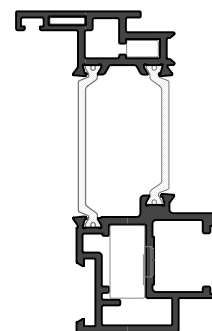

**MX753.308**

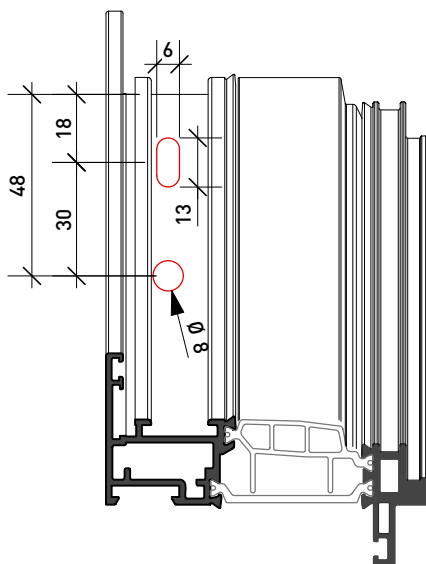

**Esclusione Asola 13x6 mm.**  
*Exclusion Slot 13x6 mm.*

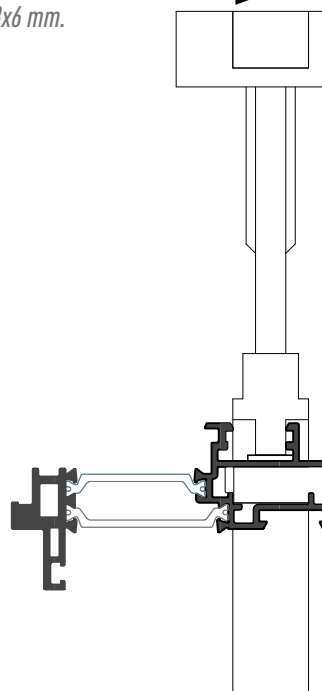

**ATTENZIONE | ATTENTION**  
TUTTE LE BATTUTE SONO | ALL THE STOPS ARE TO BE  
DA REGISTRARE | ADJUSTED

MATRICE | MATRIX: **RX0701012**  
PUNZONE | DRILLING PUNCH: **08 mm. RX0701014**  
PUNZONE | DRILLING PUNCH: **13x06 mm. RX0701015**





■ **FORO SQUADRETTA**

**ACX49.SQ**

► HOLE for CORNER JOINT  
**ACX49.SQ**

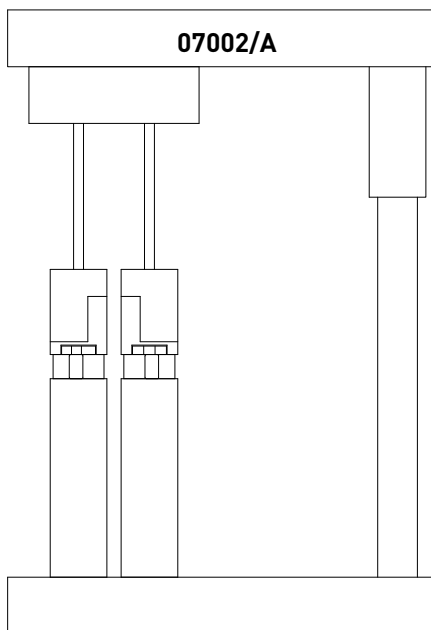

■ **CON GUIDA AGGIUNTIVA DEDICATA PER**  
**MX753.105 | MX753.104**

► WITH ADDITIONAL GUIDE DEDICATED FOR  
**MX753.105 | MX753.104**

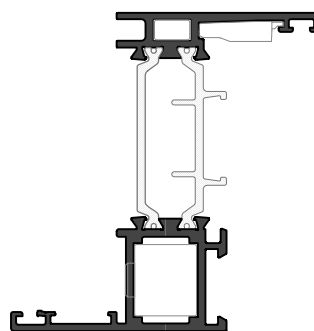

**MX753.105**

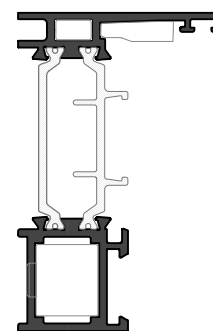

**MX753.104**

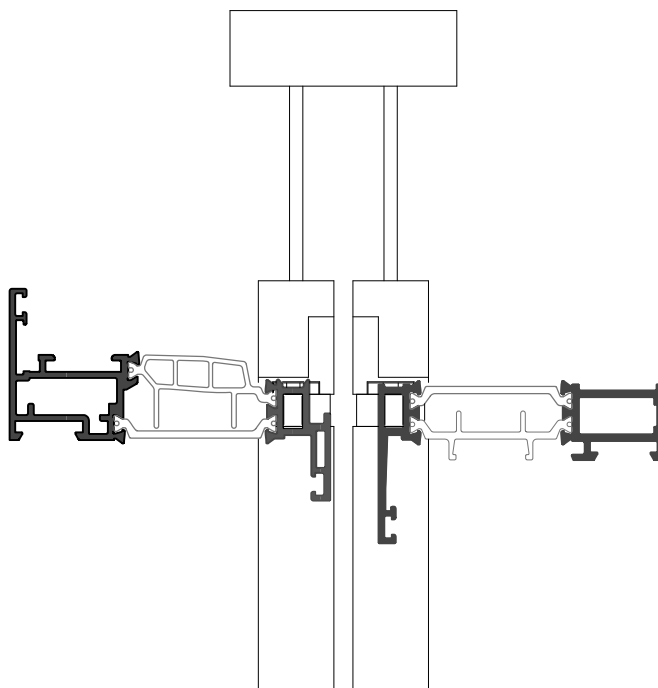
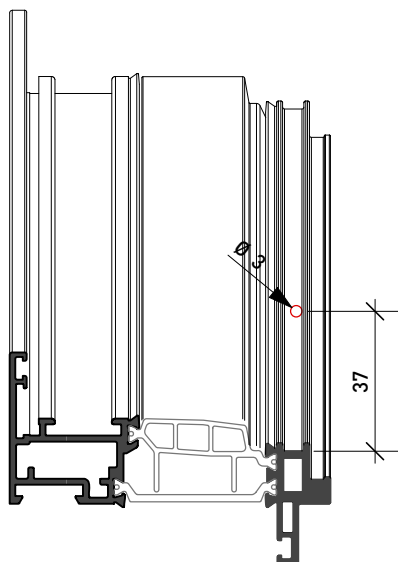

**ATTENZIONE | ATTENTION**

TUTTE LE BATTUTE SONO DA REGISTRARE | ALL THE STOPS ARE TO BE ADJUSTED

MATRICE | MATRIX: **RX0702012S**  
MATRICE | MATRIX: **RX0702012D**  
PUNZONE | DRILLING PUNCH: **Ø3 mm. RX0702014**

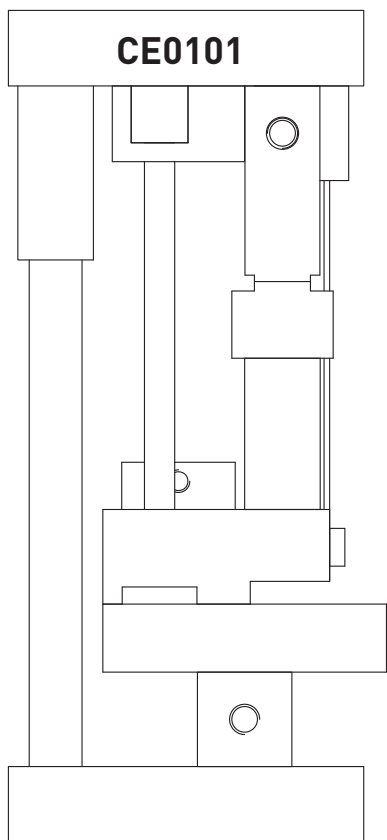

**CE0101**

**Battuta per Foratura di TESTA ASTINA**  
*STOP for Bar Head Drilling*

**Inserimento ASTINA**  
*BAR Insertion*

**Esclusore per doppio foro ASTINA**  
*Excluder for Double BAR HOLE*

**Inserimento Profilo per SPIZZATURA**  
*Insertion Profile for V-Cutting*

**Inserimento Profilo per CREMONESE**  
*Insertion Profile for CREMONESE BOLT*

- Lavorazione CREMONESE da 104 mm.
- Foro 08 mm. di TESTA e PASSANTE, Doppio Foro da 08 mm. su ASTINA
- ASPORTAZIONI DENTINI PASSAGGIO ASTA

- CREMONESE BOLT TOOLING 104 mm.
- Ø8 HEAD AND THROUGH HOLE, DOUBLE Ø8 HOLE ON BAR
- REMOVAL OF BAR PASSING TEETH

■ **MONTAGGIO SQUADRETTA PROF EXT**  
**ARX15.SQ | TAGLIO A 45/90° PARTI FISSE**

► **ASSEMBLY OF CORNER JOINT SLOT EXT PROF**  
**ARX15.SQ | 45/90° CUT FIXED PARTS**

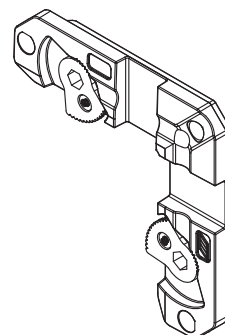
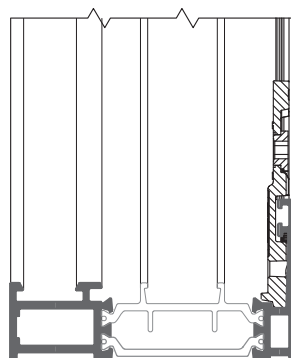



**Applicazione Accessori**  
*Application of Accessories*

■ **MONTAGGIO SQUADRETTA PROF EXT**  
**ARX15.SQ | TAGLIO A 45/90° PARTI FISSE**

► ASSEMBLY OF CORNER JOINT SLOT EXT PROF  
ARX15.SQ | 45/90° CUT FIXED PARTS

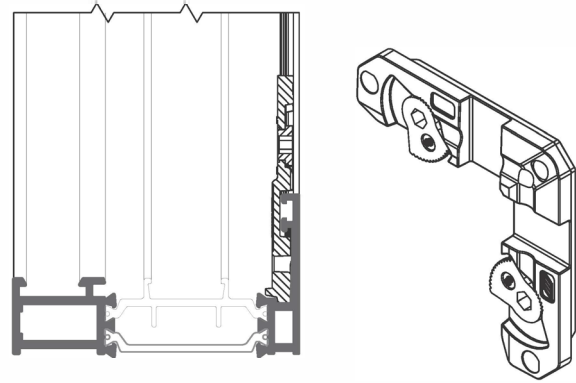

■ **MONTAGGIO CAVALLOTTO**  
**ACX47.SQ**

► STAND ASSEMBLY  
ACX47.SQ

MX753.101

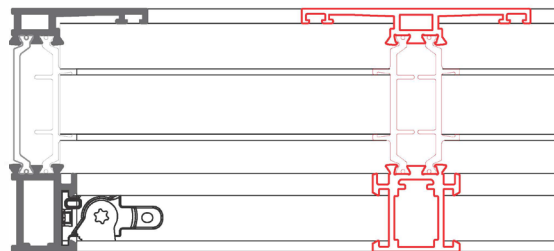

MX753.416

MX753.235

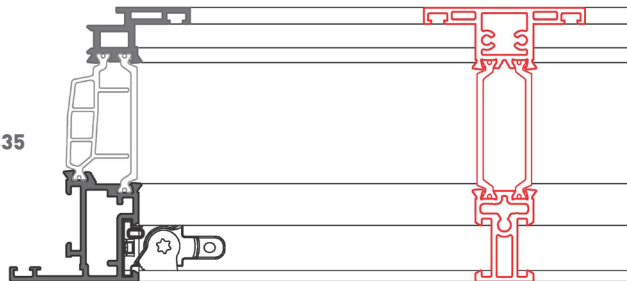

MX753.405



MX753.202

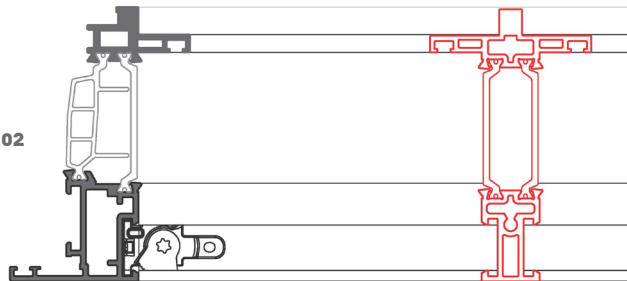

MX753.405

MX753.201

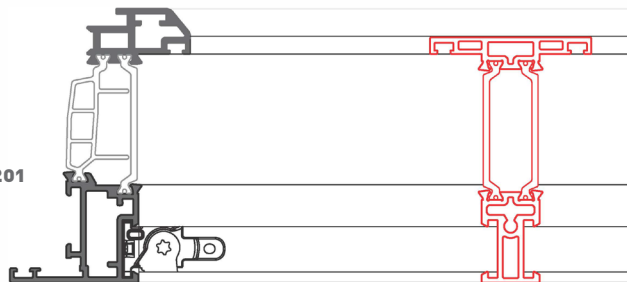

MX753.405



**Applicazione Accessori**  
*Application of Accessories*

■ **MONTAGGIO SQUADRETTA**  
**ACX50.SQ | ACX49.SQ**

► **ASSEMBLY OF CORNER JOINT SLOT**  
**ACX50.SQ | ACX.49.SQ**

**ACX50SQ**  
**ACX49SQ**

TELAI | FRAMES: **MX753.101 | MX753.102**

- Lavorazione eseguibile con attrezzatura 07001 e 07002 per spinatura esterna
- *Machining can be performed with equipment 07001 and 07002 for external pinning*

**ACX50SQ**  
**ACX49SQ**  
**ACX55.SQ**

ANTA | SASH: **MX753.202**

- Lavorazione eseguibile con attrezzatura 07001 e 07002 per spinatura esterna
- *Machining can be performed with equipment 07001 and 07002 for external pinning*

**ACX50SQ**  
**ACX49SQ**  
**ACX54.SQ**

ANTA | SASH: **MX753.201**

- Lavorazione eseguibile con attrezzatura 07001 e 07002 per spinatura esterna
- *Machining can be performed with equipment 07001 and 07002 for external pinning*

**ACX50SQ**  
**ACX49SQ**  
**ACX54.SQ**

ANTA | SASH: **MX753.235**

- Lavorazione eseguibile con attrezzatura 07001 e 07002 per spinatura esterna
- *Machining can be performed with equipment 07001 and 07002 for external pinning*



**Applicazione Accessori**  
*Application of Accessories*

■ **MONTAGGIO SQUADRETTA**  
**ACX51.SQ | ACX49.SQ**

► **ASSEMBLY OF CORNER JOINT SLOT**  
**ACX51.SQ | ACX.49.SQ**

**ACX51.SQ**  
**ACX49.SQ**

**TELAI | FRAMES: MX753.101 | MX753.102**

- Lavorazione eseguibile con attrezzatura 07001 e 07002 per spinatura esterna
- *Machining can be performed with equipment 07001 and 07002 for external pinning*

**ACX51.SQ**  
**ACX49.SQ**  
**ACX55.SQ**

**ANTA | SASH: MX753.202**

- Lavorazione eseguibile con attrezzatura 07001 e 07002 per spinatura esterna
- *Machining can be performed with equipment 07001 and 07002 for external pinning*

**ACX51.SQ**  
**ACX49.SQ**  
**ACX54.SQ**

**ANTA | SASH: MX753.201**

- Lavorazione eseguibile con attrezzatura 07001 e 07002 per spinatura esterna
- *Machining can be performed with equipment 07001 and 07002 for external pinning*

**ACX51.SQ**  
**ACX49.SQ**  
**ACX54.SQ**

**ANTA | SASH: MX753.235**

- Lavorazione eseguibile con attrezzatura 07001 e 07002 per spinatura esterna
- *Machining can be performed with equipment 07001 and 07002 for external pinning*



**Applicazione Accessori**  
*Application of Accessories*

■ **TERMINALE ASTA**

**ACX03.12**

► *BAR TERMINAL*  
**ACX03.12**

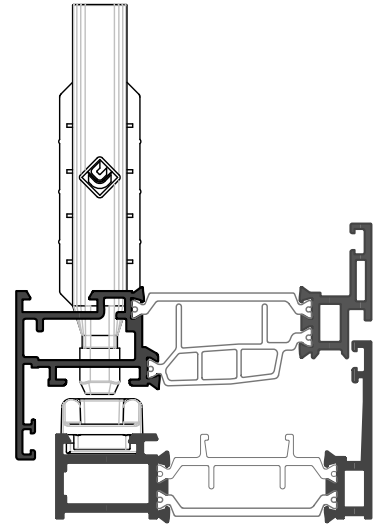
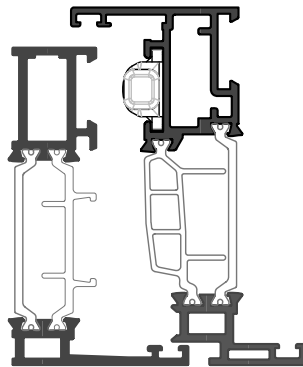

■ **TERMINALE ASTA IN ZAMA**

**ACX03.18**

► *ZAMAC BAR TERMINAL*  
**ACX03.18**

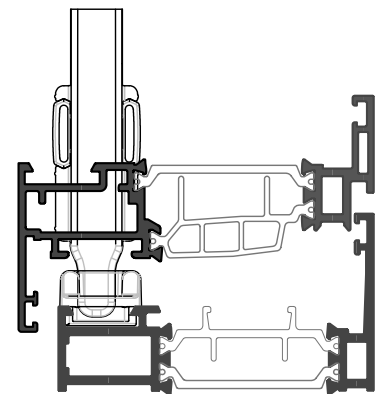
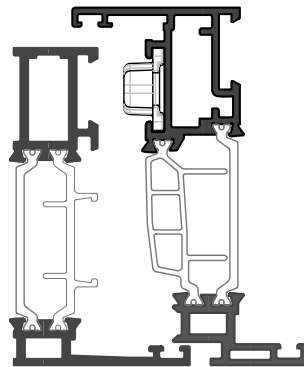
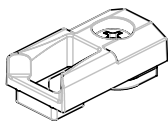
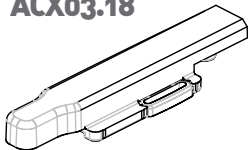

■ **INCONTRO ASTA SINGOLO IN ZAMA**

**ACX08.13**

► *SINGLE ZAMAC BAR REST PLATE*  
**ACX08.13**



**Applicazione Accessori**  
*Application of Accessories*

■ **CATENACCIO A LEVA**  
**ACX03.11**

► **LEVER BOLT**  
**ACX03.11**

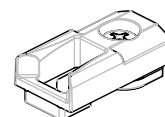
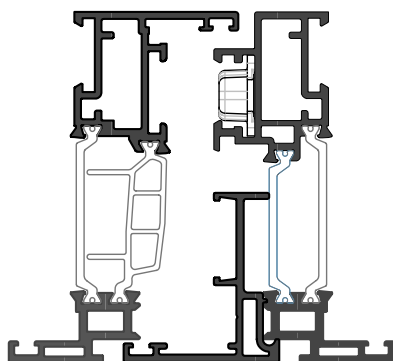
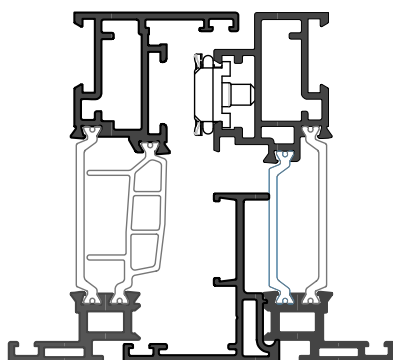
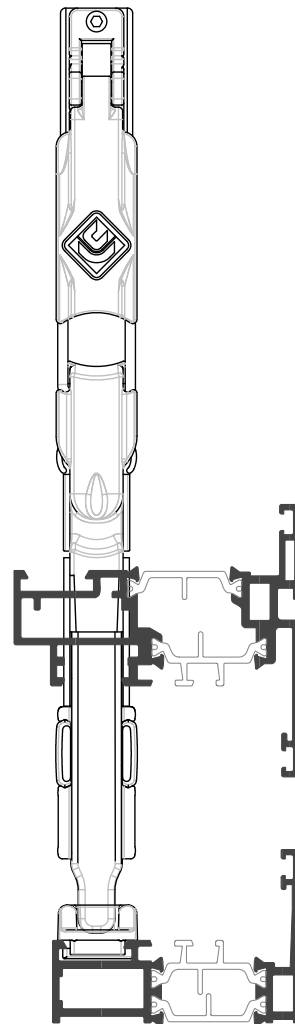
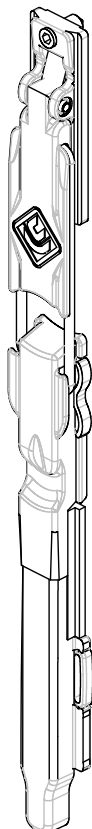

■ **INCONTRO ASTA**  
**ACX08.13**

► **BAR REST PLATE**  
**ACX08.13**

**Applicazione Accessori**  
*Application of Accessories***■ KIT CHIUSURA SUPPL c/ECCENTRICO**  
**ACX03.16**

► SUPPL CLOSURE KIT w/ECCENTRIC BOLT  
ACX03.16

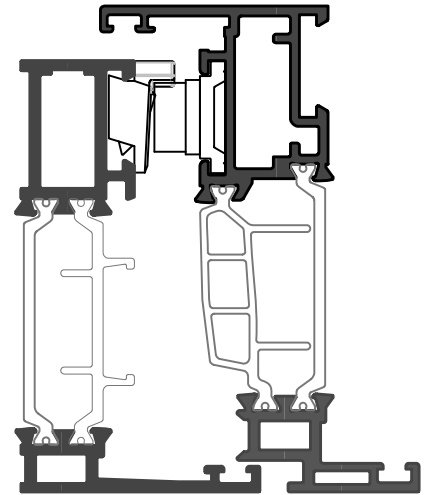
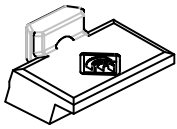
**■ INCONTRA A POZZETTO D=8 MM**  
**ACX03.63**

► DRAIN REST PLATE D=8 MM  
ACX03.63

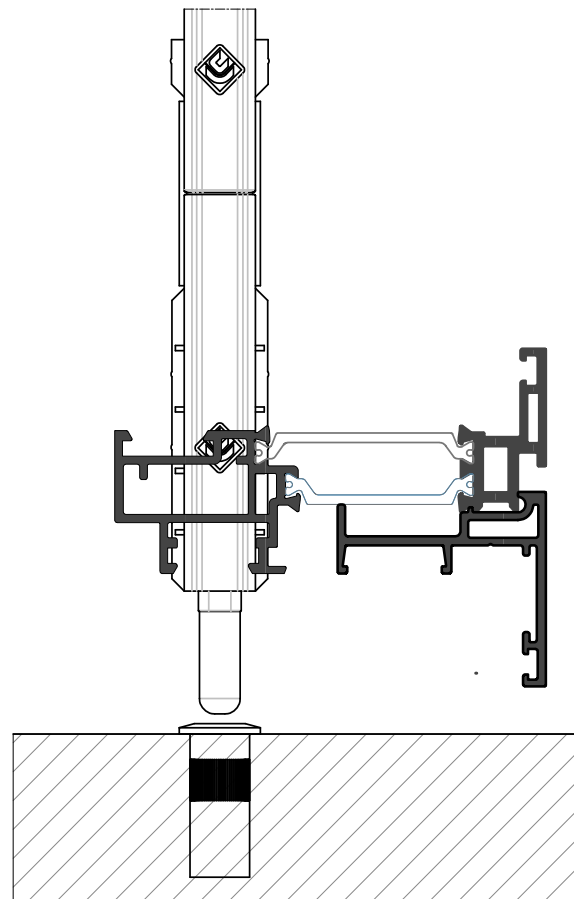
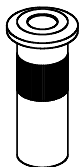





**Applicazione Accessori**  
*Application of Accessories*

■ **KIT SOSTEGNO ANTA**

**ACX03.19**

► *DOOR SUPPORT KIT*  
**ACX03.19**

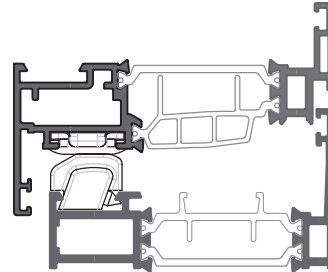
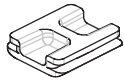
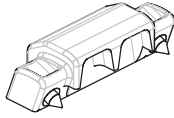

■ **ROSTRO REGOLABILE**

**ACX03.29**

► *ADJUSTABLE BOLT*  
**ACX03.29**

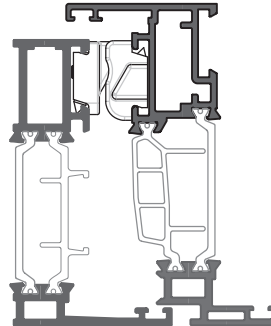
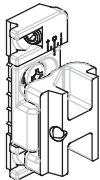

■ **CLIP FERMA ANTA**

**ACX03.15**

► *RABBET CLIP*  
**ACX03.15**

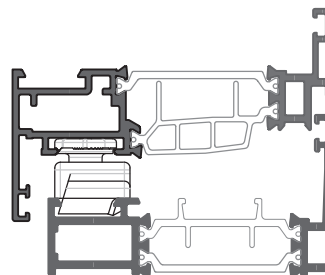
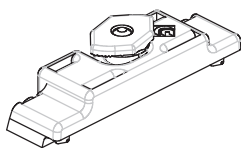



**Applicazione Accessori**  
*Application of Accessories*

■ **CAPPETTA DRENAGGIO**

**ARX05.01**

► *DRAINAGE PLUG*  
**ARX05.01**

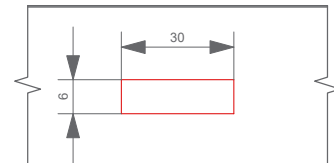
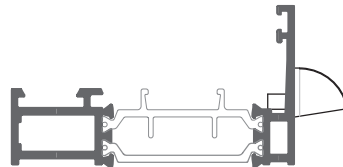
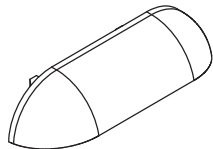

■ **PIASTRINA REGISTRO TELAIO**

**ARX06.02**

► *FRAME ADJUSTMENT PLATE*  
**ARX06.02**

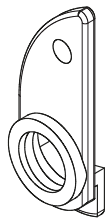

■ **ARX06.02**

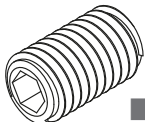

■ **ARX06.12**

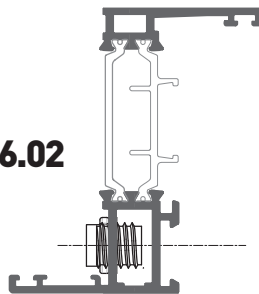

■ **REGISTRO TELAIO GRANO 12 MM**

**ARX06.12**

► *FRAME ADJUSTING SCREW 12 MM*  
**ARX06.12**

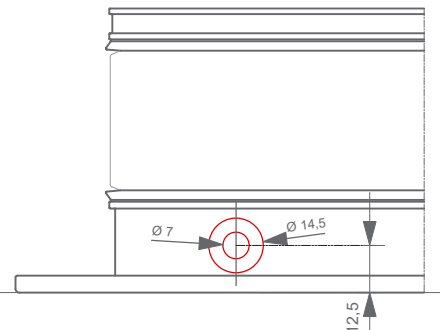
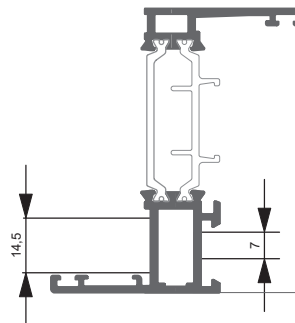

■ **MONTAGGIO SQUADRETTA**

**ARX10.SQ**

► *ASSEMBLY OF CORNER JOINT SLOT*  
**ARX10.SQ**

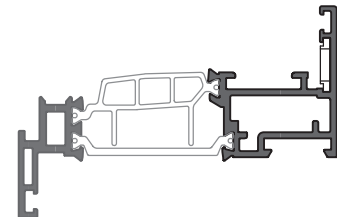
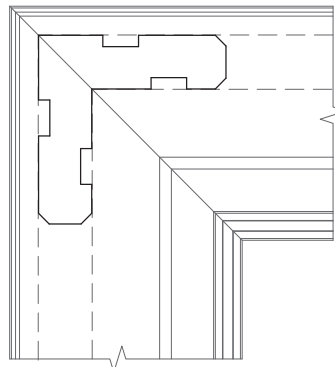
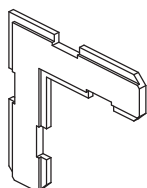



■ **Tappo Riporto Centrale [Camera Europea]**

**ACX04.57**

► *Central Wing Cap [European Chamber]*  
**ACX04.57**

**Applicazione Accessori**  
*Application of Accessories*

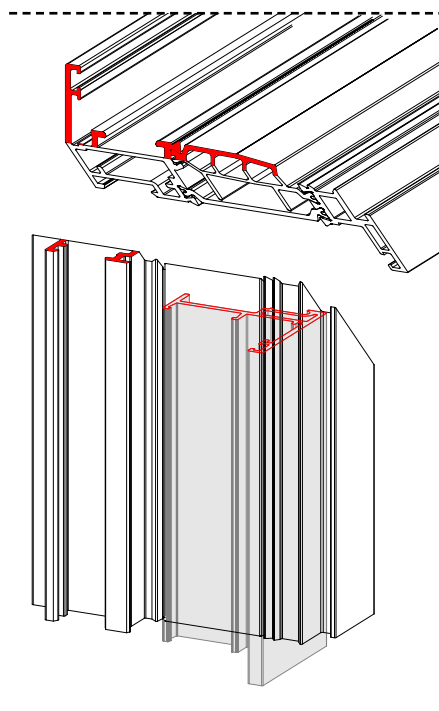
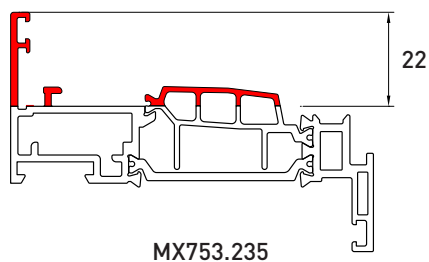
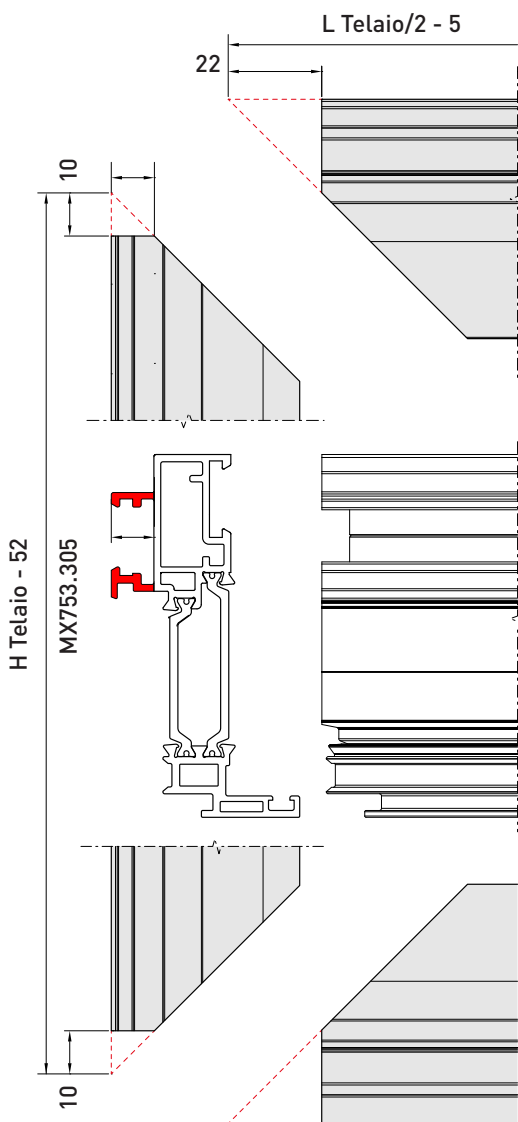
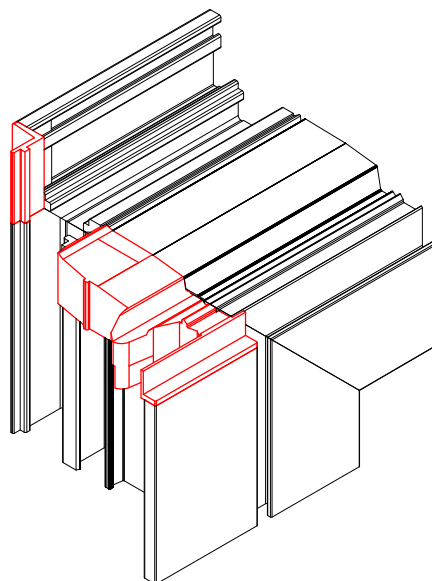
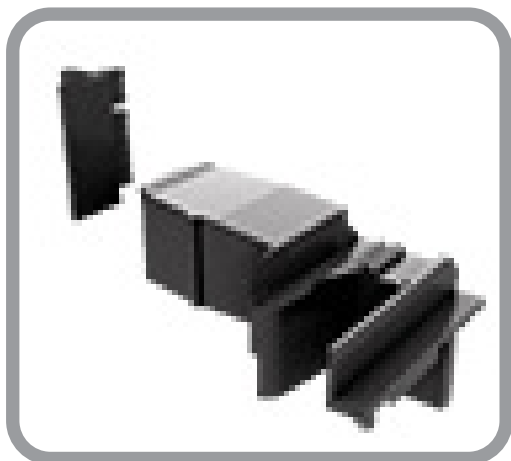



■ **Tappo Riporto Centrale [Ferramenta NASTRO]**  
**ACX04.58**  
▶ *Central Wing Cap [RIBBON Hardware]*  
**ACX04.58**

**Applicazione Accessori**  
*Application of Accessories*

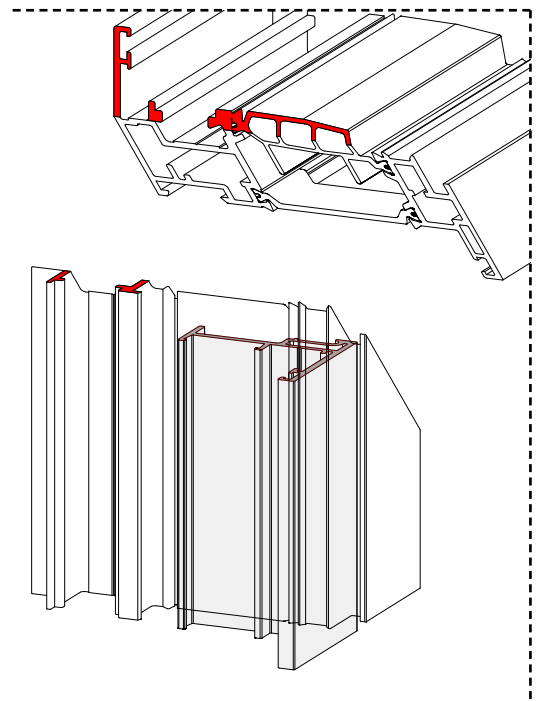
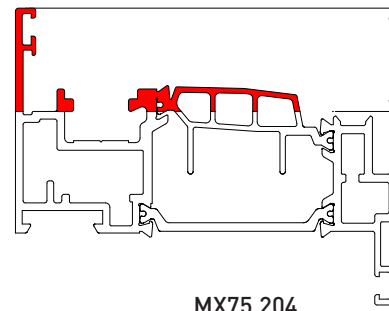
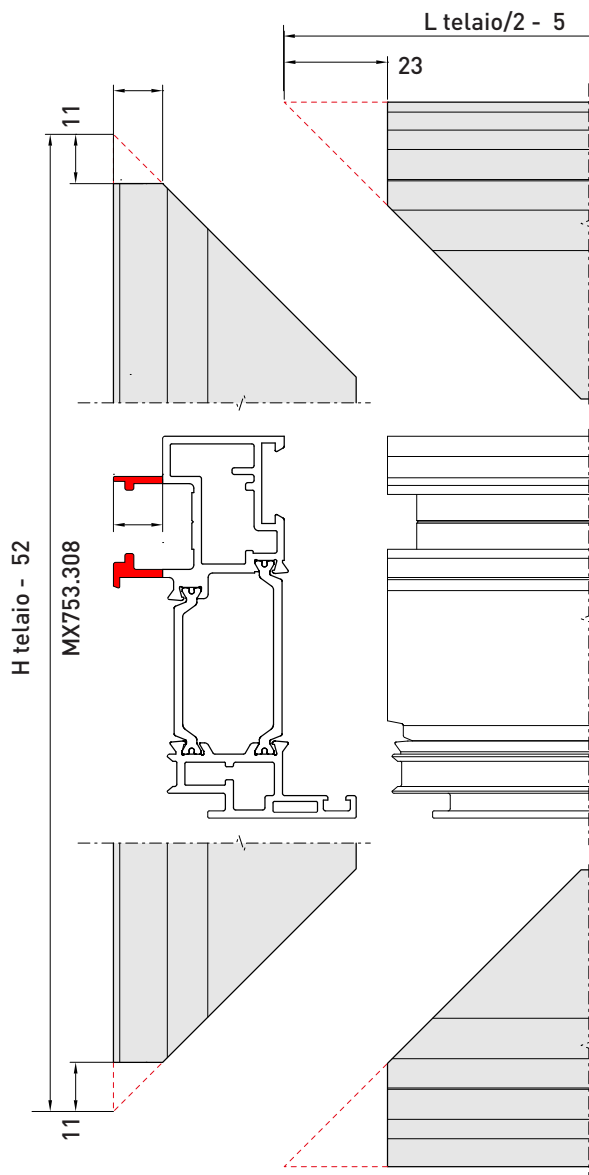
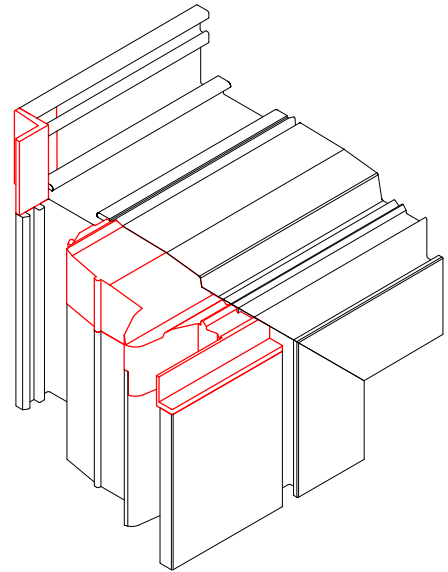
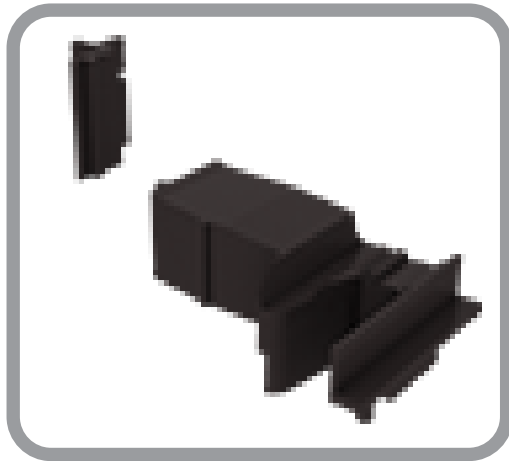



**Applicazione Accessori**  
*Application of Accessories*

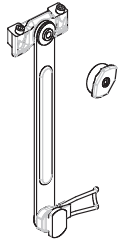

- **BRACCIO LIMITATORE**  
H Anta = DA 260mm a 800mm  
**ACX02.08**
- ▶ **LIMITER ARM DOOR**  
H Sash= from 260mm to 800mm  
**ACX02.08**

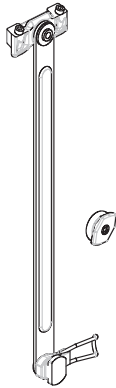

- **BRACCIO LIMITATORE**  
H Anta = DA 600mm a 1600mm  
**ACX02.07**
- ▶ **LIMITER ARM DOOR**  
H Sash= from 600mm to 1600mm  
**ACX02.07**



- **BRACCIO TELESCOPICO A SCATTO**  
**ACX02.09**
- ▶ **ONE CLICK TELESCOPIC ARM**  
**ACX02.09**

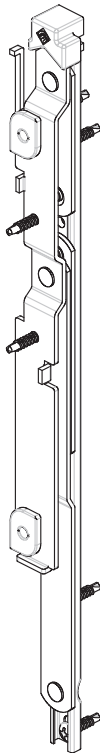
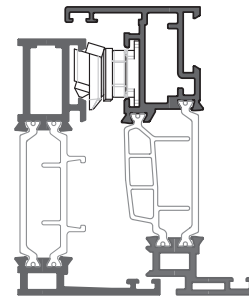

- **CERNIERA A COMPASSO**  
**ACX02.10**
- ▶ **COMPASS HINGE**  
**ACX02.10**

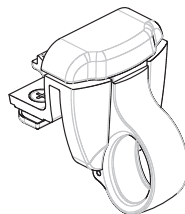
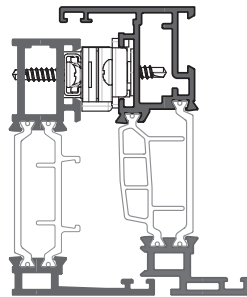

- **CRICCHETTO AD AGGANCIAMENTO CON PIASTRINE**  
**ACX03.01**
- ▶ **COUPLING RATCHET WITH PLATES**  
**ACX03.01**

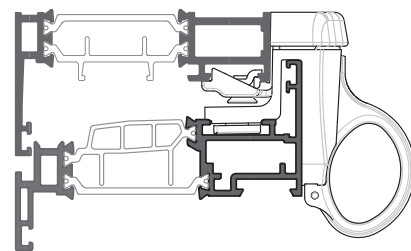



**Applicazione Accessori**  
*Application of Accessories*

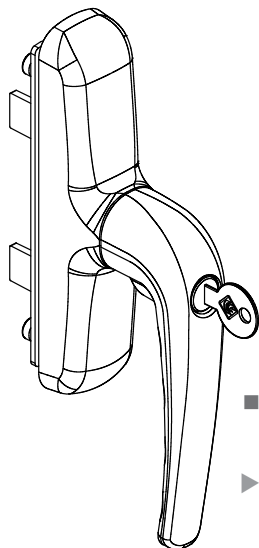

- **CREMONESE CON CHIAVE**  
Interasse 84 - 92 - 104  
**ARX03.07**
- ▶ **CREMONESE HANDLE w/KEY**  
Int. 84 - 92 - 104  
**ARX03.07**

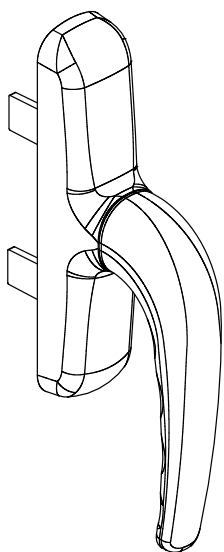
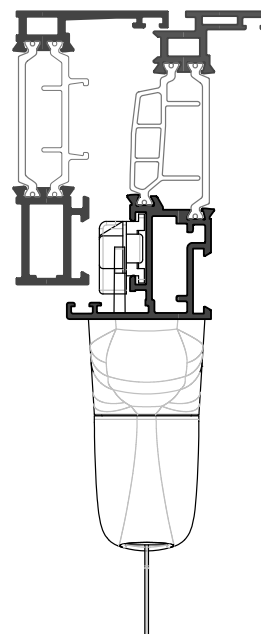
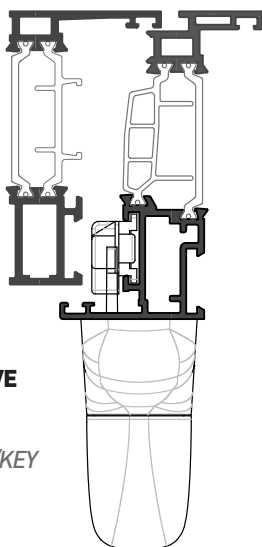

- **CREMONESE**  
Interasse 84 - 92 - 104  
**ARX03.06**
- ▶ **CREMONESE HANDLE**  
Int. 84 - 92 - 104  
**ARX03.06**

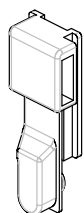
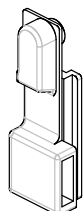
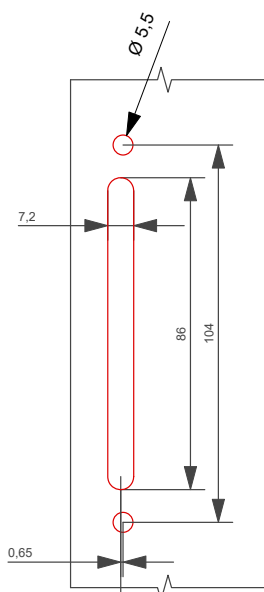

- **INNESTI CREMONESE**  
**ACX03.17**
- ▶ **WINDING PIVOT**  
**ACX03.17**

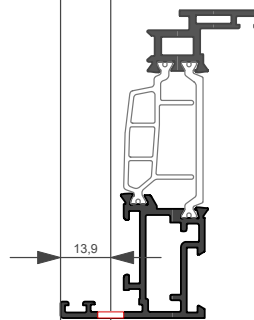



**Applicazione Accessori**  
*Application of Accessories*

■ **“SHARK MINIMAL” ACX08.50**  
**MOVIMENTAZIONE MONODIREZIONALE**  
**ENTRATA 3,3MM CON**

- **“ITALIA” MARTELLINA MINIMAL DESIGN SENZA BASETTA**  
**ACX08.51**
- **“TWIN” MARTELLINA MINIMAL DESIGN SENZA BASETTA**  
**ACX08.52**

► **“SHARK MINIMAL” ACX08.50**  
**ONE-WAY ENTRY HANDLING**  
**3,3MM WITH**

- **“ITALIA” MARTELLINA HANDLE MIN. DESIGN WITHOUT BASE**  
**ACX08.51**
- **“TWIN” MARTELLINA HANDLE MIN. DESIGN WITHOUT BASE**  
**ACX08.52**

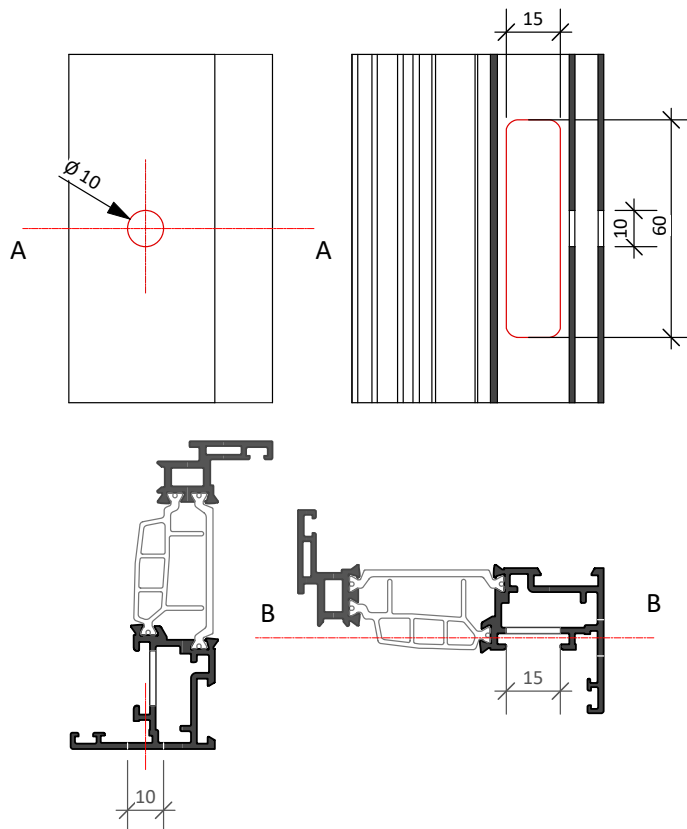

| Articolo        | Immagine | Descrizione   |
|-----------------|----------|---|
| <b>ACX08.50</b> |          | “SHARK MINIMAL”<br>Movimentazione<br>monodirezionale con anti<br>falsa manovra con punto di<br>chiusura<br>- entrata 3,3 mm - |
| <b>ACX08.51</b> |          | “ITALIA” Martellina minimal<br>design - sporgenza quadro<br>24-33,5 mm  |
| <b>ACX08.52</b> |          | “TWIN” Martellina minimal<br>design - sporgenza quadro<br>24-33,5 mm  |

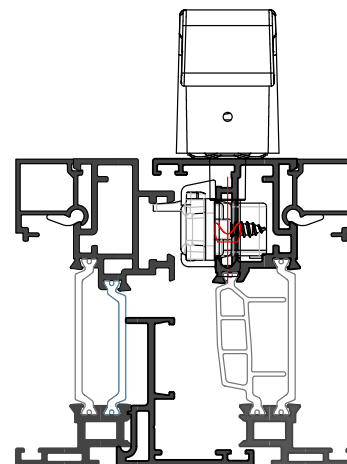
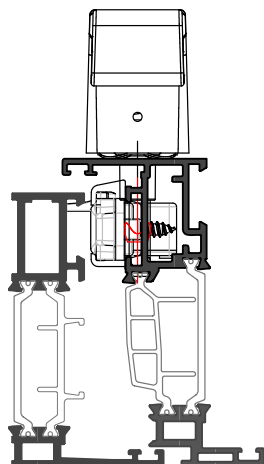



**Applicazione Accessori**  
*Application of Accessories*

■ **"SHARK MINIMAL" ACX08.53**  
**MOVIMENTAZIONE MONODIREZIONALE**  
**ENTRATA 3,3MM CON**

- "ITALIA" MARTELLINA MINIMAL DESIGN CON BASETTA **ACX08.54**
- "TWIN" MARTELLINA MINIMAL DESIGN CON BASETTA **ACX08.55**

▶ **"SHARK MINIMAL" ACX08.53**  
**ONE-WAY ENTRY HANDLING**  
**3,3MM WITH**

- ▶ "ITALIA" MARTELLINA HANDLE MIN. DESIGN W/BASE **ACX08.54**
- ▶ "TWIN" MARTELLINA HANDLE MIN. DESIGN W/BASE **ACX08.55**

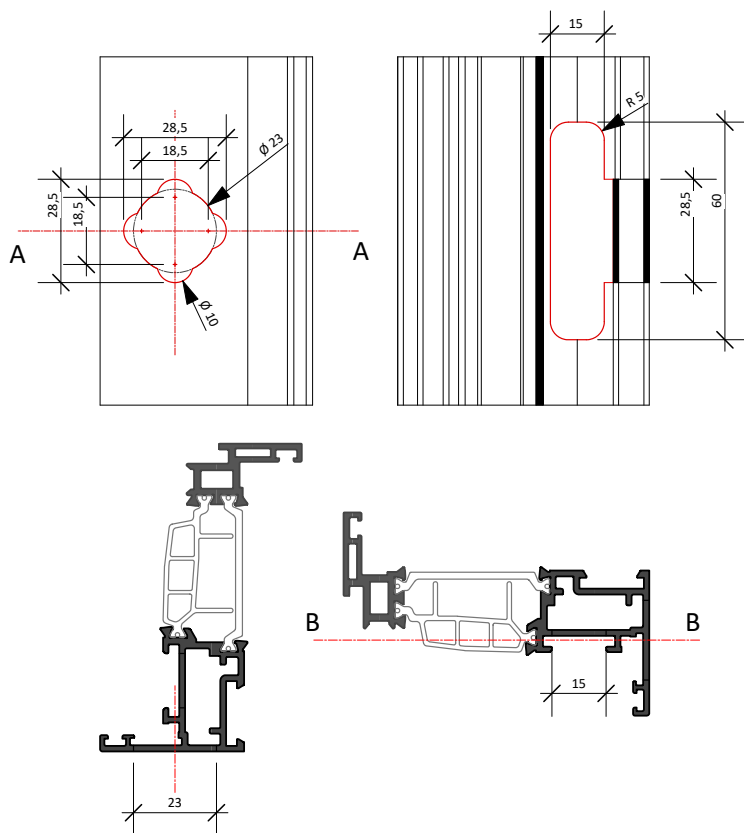

| Articolo        | Immagine | Descrizione  |
|-----------------|----------|--|
| <b>ACX08.53</b> |          | "SHARK MINIMAL" Movimentazione monodirezionale con anti falsa manovra con punto di chiusura - entrata 3,3 mm - |
| <b>ACX08.54</b> |          | "ITALIA" Martellina minimal design - sporgenza quadro 17,5-27 mm   |
| <b>ACX08.55</b> |          | "TWIN" Martellina minimal design - sporgenza quadro 17,5-27 mm   |

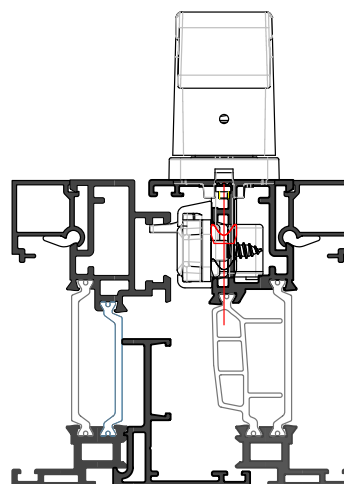
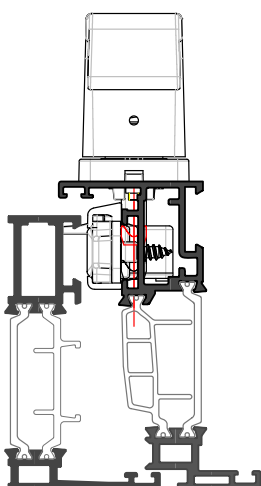





**Applicazione Accessori**  
*Application of Accessories*

■ **“SHARK MINIMAL” ACX08.53**  
**MOVIMENTAZIONE MONODIREZIONALE**  
**ENTRATA 3,3MM CON**

- **“ITALIA” MARTELLINA MINIMAL DESIGN CON BASETTA**  
**INT. 43MM**  
**ACX08.56**
- **“TWIN” MARTELLINA MINIMAL DESIGN CON BASETTA**  
**INT. 43MM**  
**ACX08.57**

► **“SHARK MINIMAL” ACX08.53**  
**ONE-WAY ENTRY HANDLING**  
**3,3MM WITH**

- **“ITALIA” MARTELLINA HANDLE MIN. DESIGN WITH BASE**  
**INT. 43MM**  
**ACX08.56**
- **“TWIN” MARTELLINA HANDLE MIN. DESIGN WITH BASE**  
**INT. 43MM**  
**ACX08.57**

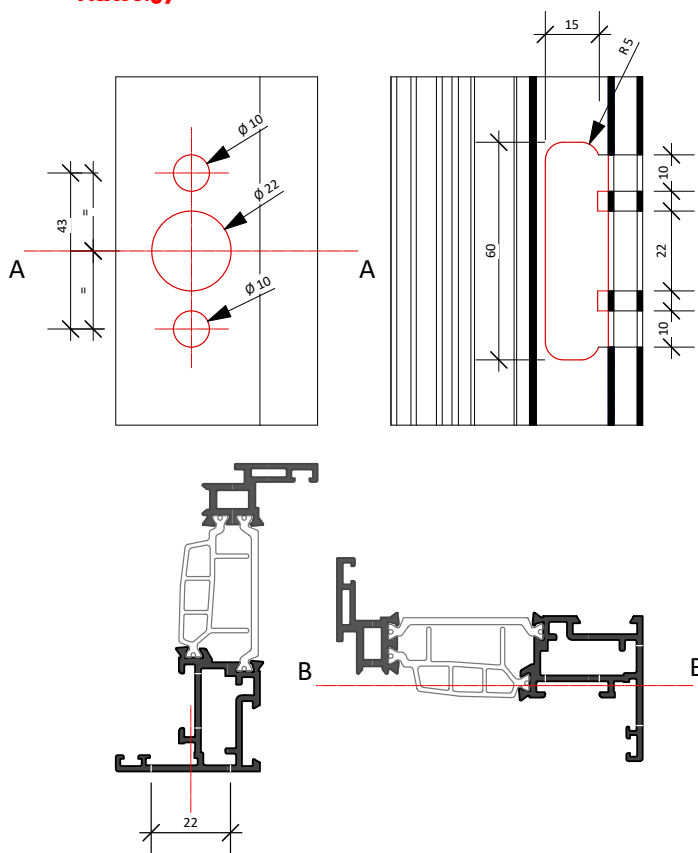

| Articolo        | Immagine | Descrizione   |
|-----------------|----------|---|
| <b>ACX08.53</b> |          | “SHARK MINIMAL”<br>Movimentazione<br>monodirezionale con anti<br>falsa manovra con punto di<br>chiusura<br>- entrata 3,3 mm - |
| <b>ACX08.56</b> |          | “ITALIA” Martellina minimal<br>design - sporgenza quadro<br>17,5-27 mm  |
| <b>ACX08.57</b> |          | “TWIN” Martellina minimal<br>design - sporgenza quadro<br>17,5-27 mm  |

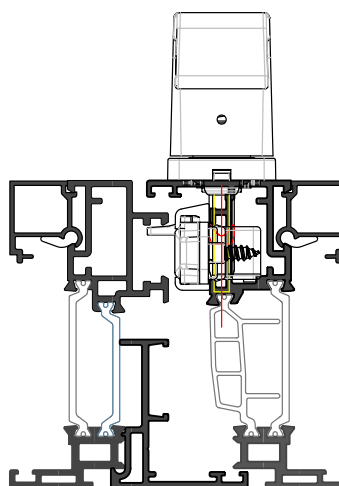
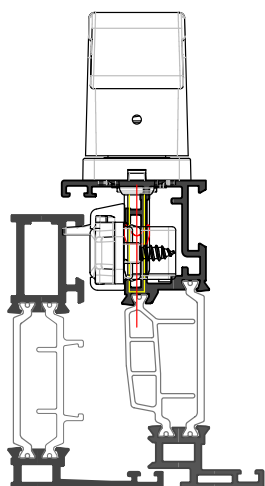



# GRUPPI FRESE



## GRFW21CAS3553

- Gruppo frese Fermavetri "linea ferro"
- ▶ Glazing Bead "Iron Line" Milling Unit

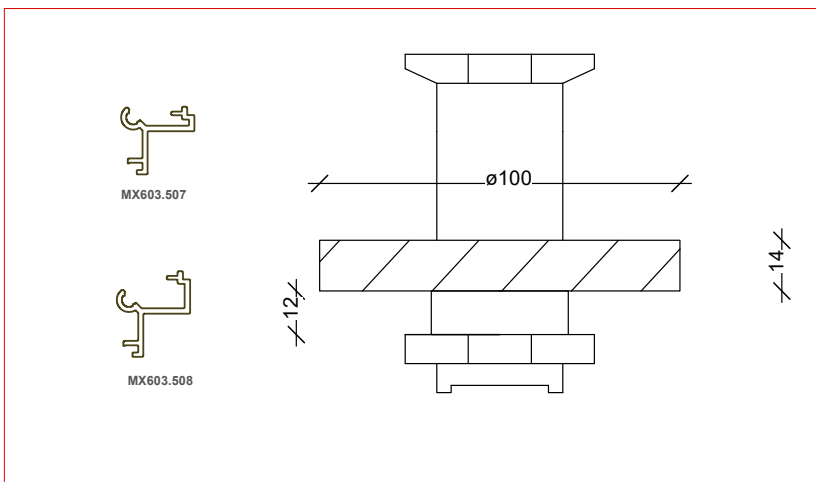

## GRFW41CAS3553

- Gruppo frese Trav/Telaio Parti Fisse
- ▶ Crosspiece/Door frame Milling Unit Fixed Part

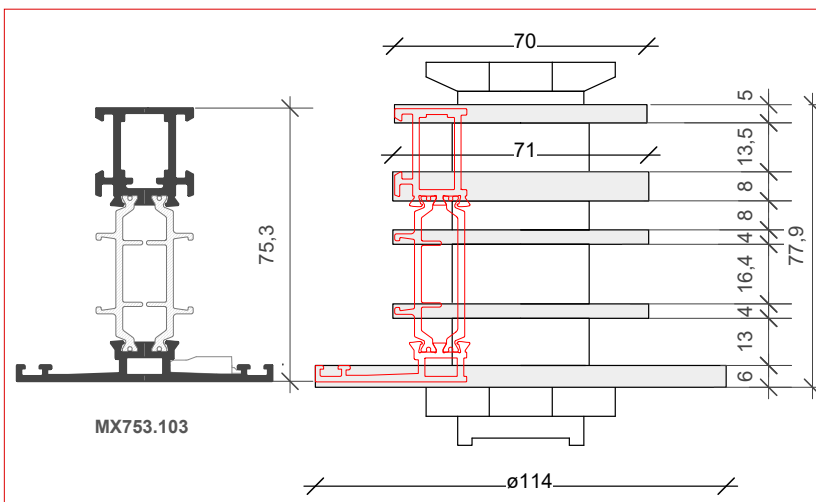

## GRFW42CAS3553

- Gruppo frese Trav/Anta MX753.201
- ▶ Crosspiece/Sash frame Milling Unit MX753.201

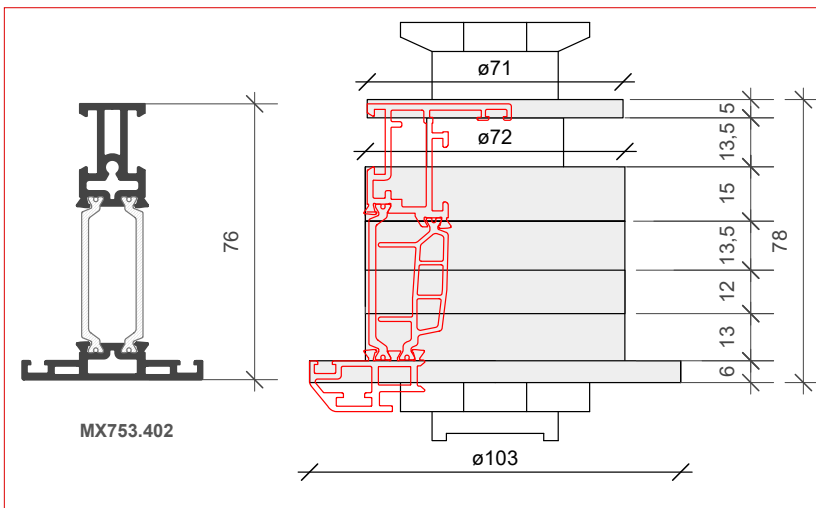



## GRUPPI FRESE



### GRFW43CAS3553

- Gruppo frese Trav/Anta  
**MX753.235**
- ▶ Crosspiece/Sash frame  
Milling Unit  
**MX753.235**

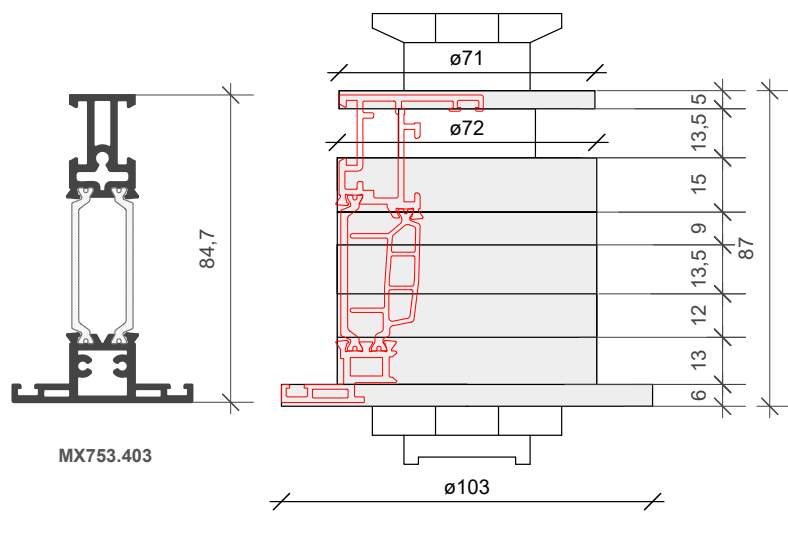

### GRFW44CAS3553

- Gruppo frese Trav/Anta  
**MX753.202**
- ▶ Crosspiece/Sash frame  
Milling Unit  
**MX753.202**

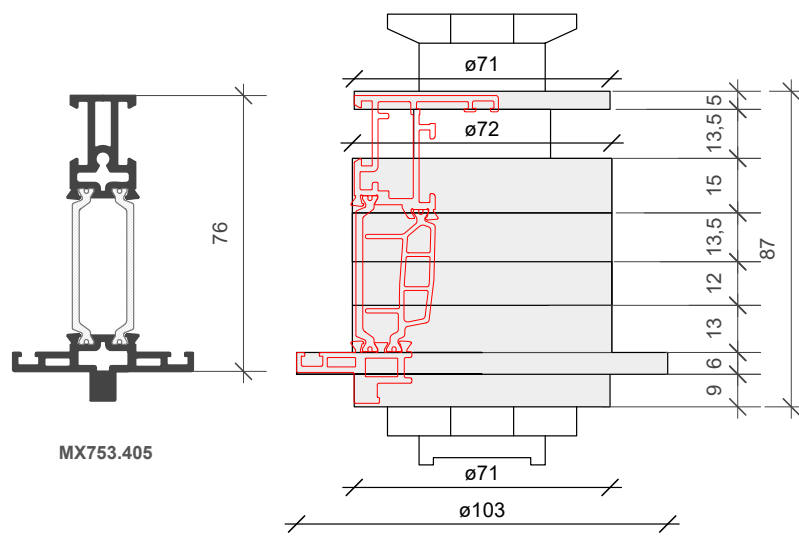



**Applicazione Accessori**  
*Application of Accessories*

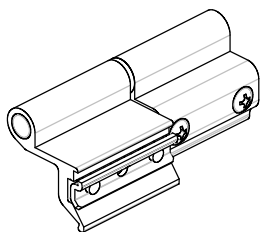

- **CERNIERA A MONTAGGIO RAPIDO A 2 ALI**  
**ACX02.01**
- ▶ *RAPID ASSEMBLY 2-LEAFED HINGE*  
**ACX02.01**

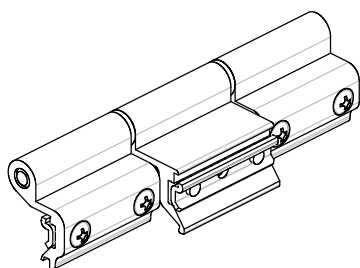

- **CERNIERA A MONTAGGIO RAPIDO A 3 ALI**  
**ACX02.03**
- ▶ *RAPID ASSEMBLY 3-LEAFED HINGE*  
**ACX02.03**

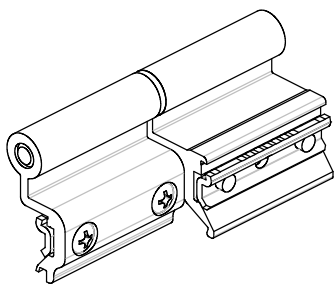
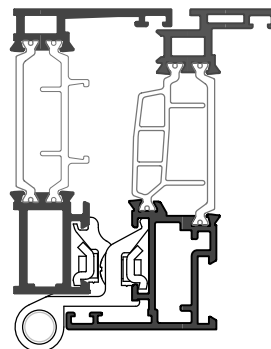

- **CERNIERA A MONTAGGIO RAPIDO A 2 ALI**  
**ACX02.40**
- ▶ *RAPID ASSEMBLY 2-LEAFED HINGE*  
**ACX02.40**

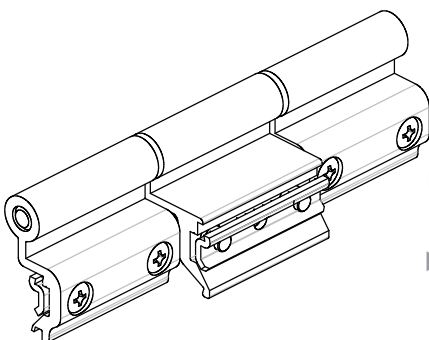

- **CERNIERA A MONTAGGIO RAPIDO A 3 ALI**  
**ACX02.41**
- ▶ *RAPID ASSEMBLY 3-LEAFED HINGE*  
**ACX02.41**

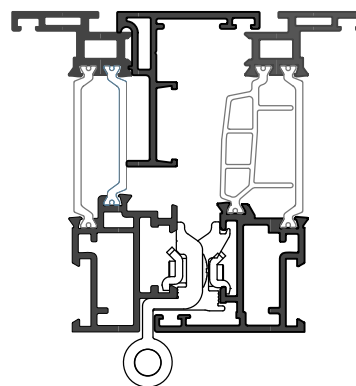



**Applicazione Accessori**  
*Application of Accessories*

■ **WEEN HIDE 180-DX BRACCIO A SCOMPARSA PER APERTURA A BATTENTE**

**ACX08.36**

- *WEEN HIDE 180 - RIGHT RETRACTABLE ARM FOR HINGED OPENING*  
**ACX08.36**

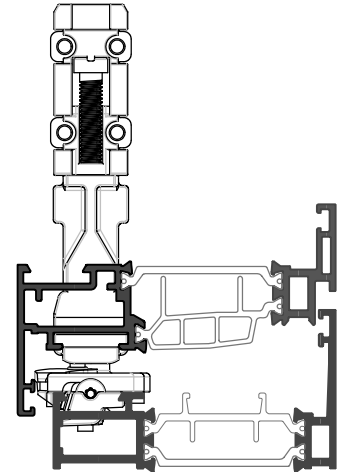
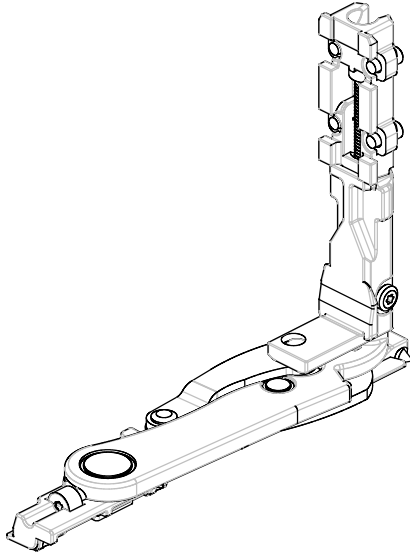

■ **WEEN HIDE 180-SX/DX CERNIERA INFERIORE**

**ACX08.39**

- *WEEN HIDE 180 - BOTTOM LEFT/RIGHT HINGE*  
**ACX08.39**

■ **WEEN HIDE 180-SX BRACCIO A SCOMPARSA PER APERTURA A BATTENTE**

**ACX08.37**

- *WEEN HIDE 180 - LEFT RETRACTABLE ARM FOR HINGED OPENING*  
**ACX08.37**

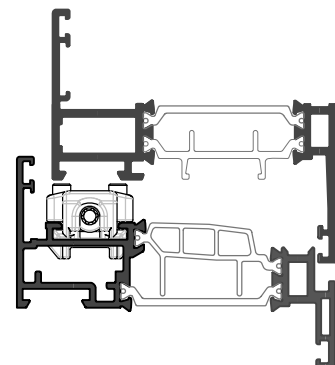
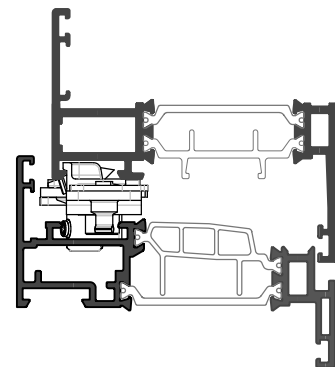
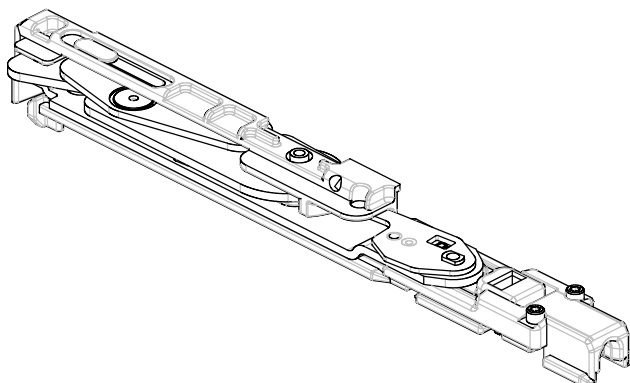



**Applicazione Accessori**  
*Application of Accessories*

■ **WEEN HIDE 180**  
**KIT BASE ANTA RIBALTA CON ANTI**  
**FALSA MANOVRA SULLA CREMONESE**  
**ACX08.40**

► **WEEN HIDE 180**  
*TILT&TURN WINDOW BASE KIT W/WRONG*  
*COUNTER-ACTUATION ON THE CREMONESE BOLT*  
**ACX08.40**

**RIBALTA**

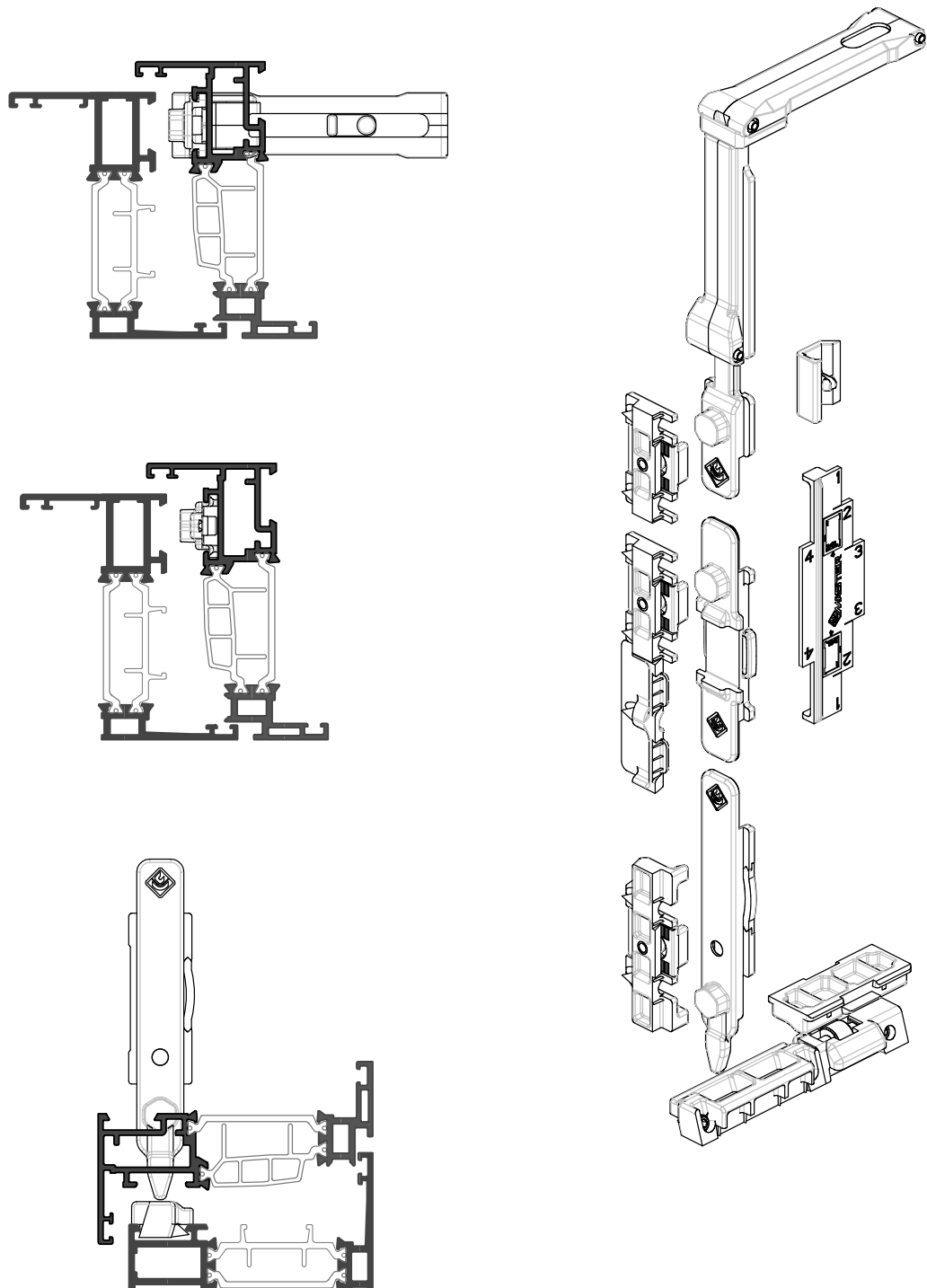



**Applicazione Accessori**  
*Application of Accessories*

■ **WEEN HIDE 180**  
**KIT BASE ANTA RIBALTA CON ANTI**  
**FALSA MANOVRA SULLA CREMONESE**  
**ACX08.41**

► **WEEN HIDE 180**  
*TILT&TURN WINDOW BASE KIT W/WRONG*  
*COUNTER-ACTUATION ON THE CREMONESE BOLT*  
**ACX08.41**

**RIBALTA**

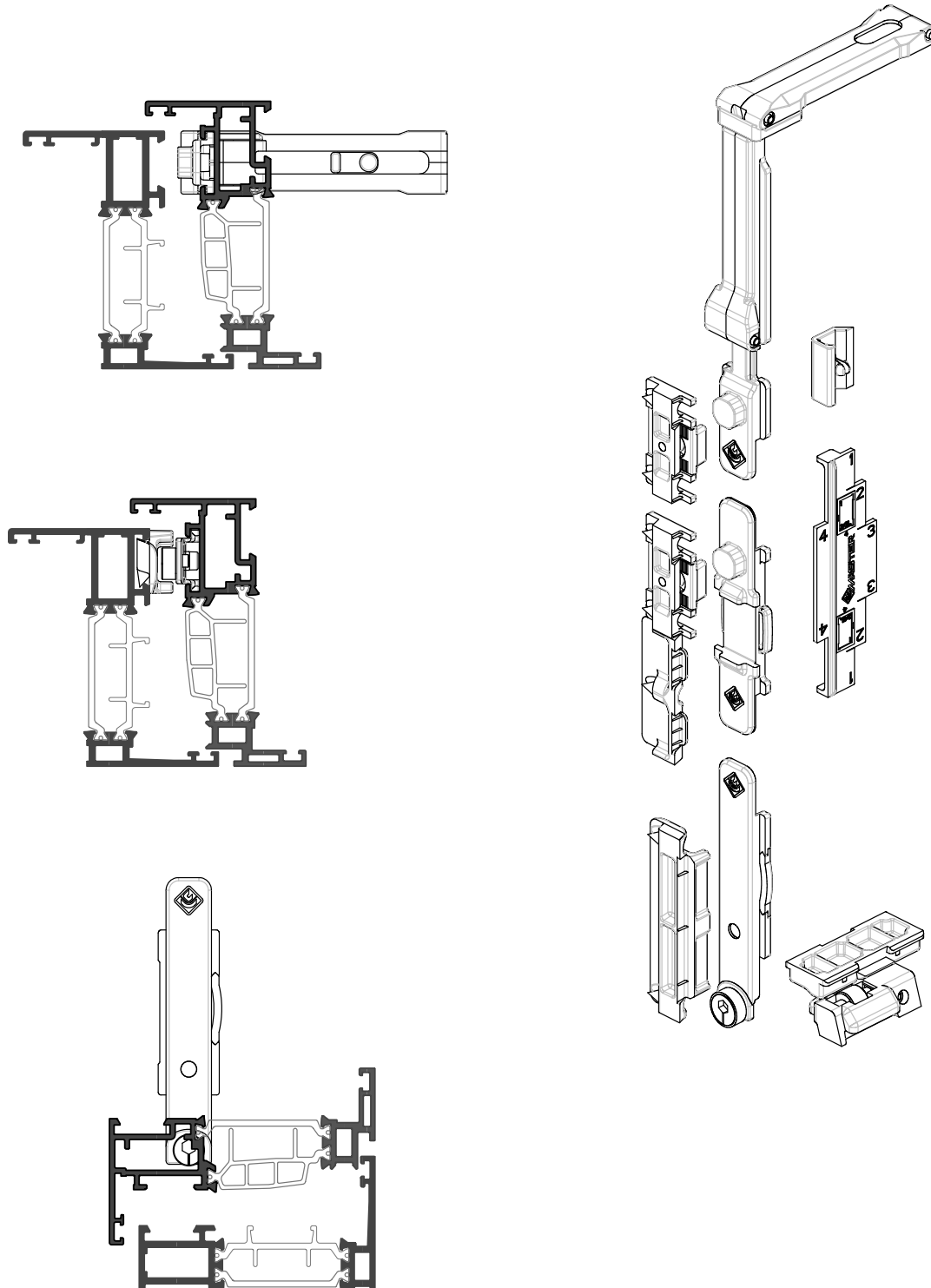



**Applicazione Accessori**  
*Application of Accessories*

■ **KIT BASE ANTA RIBALTA**  
**PORTATA MASSIMA 160KG**  
**ACX08.01**

► **TILT&TURN WINDOW BASE KIT**  
**MAXIMUM LOAD 160KG**  
**ACX08.01**

**RIBALTA**

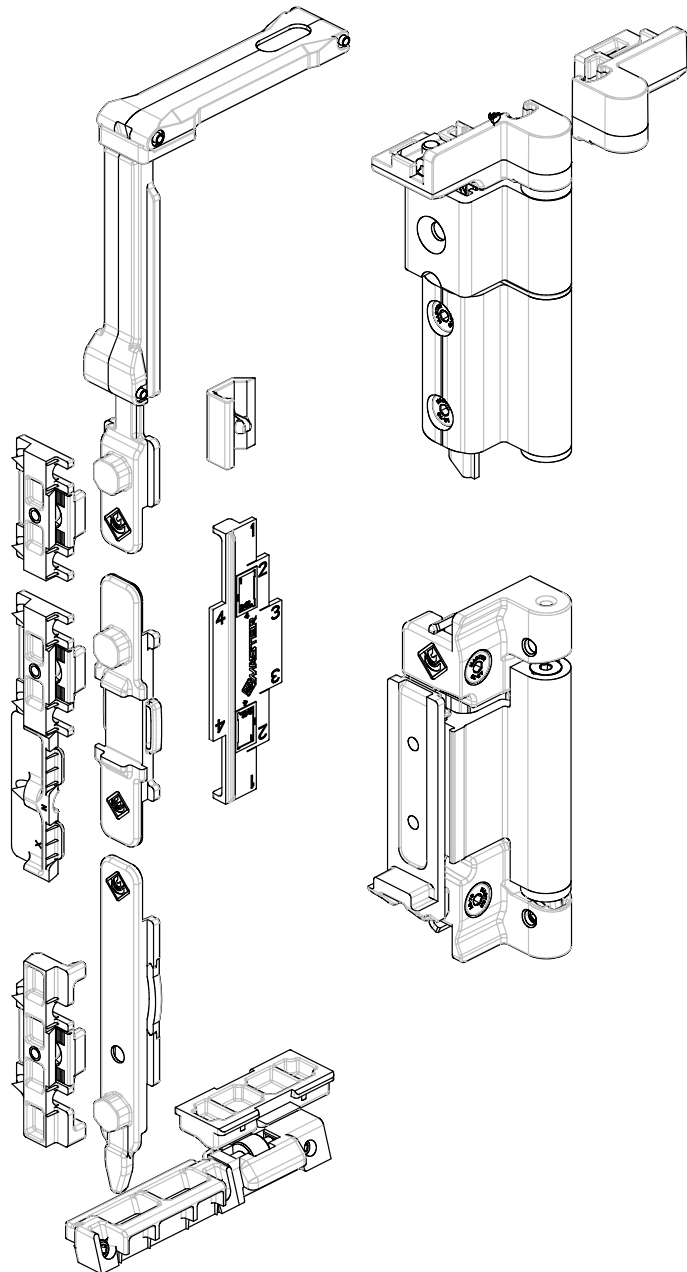
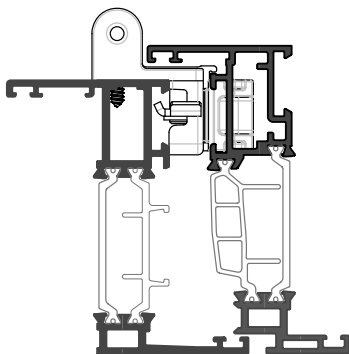
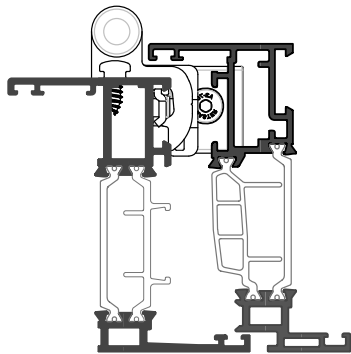





## Applicazione Accessori *Application of Accessories*

### **RIBALTA**

- **KIT CERNIERE E BRACCIO PER ANTA AFFIANCATA**  
**ACX08.25**
- ▶ **HINGES AND ARM KIT FOR SIDE BY SIDE DOOR**  
**ACX08.25**

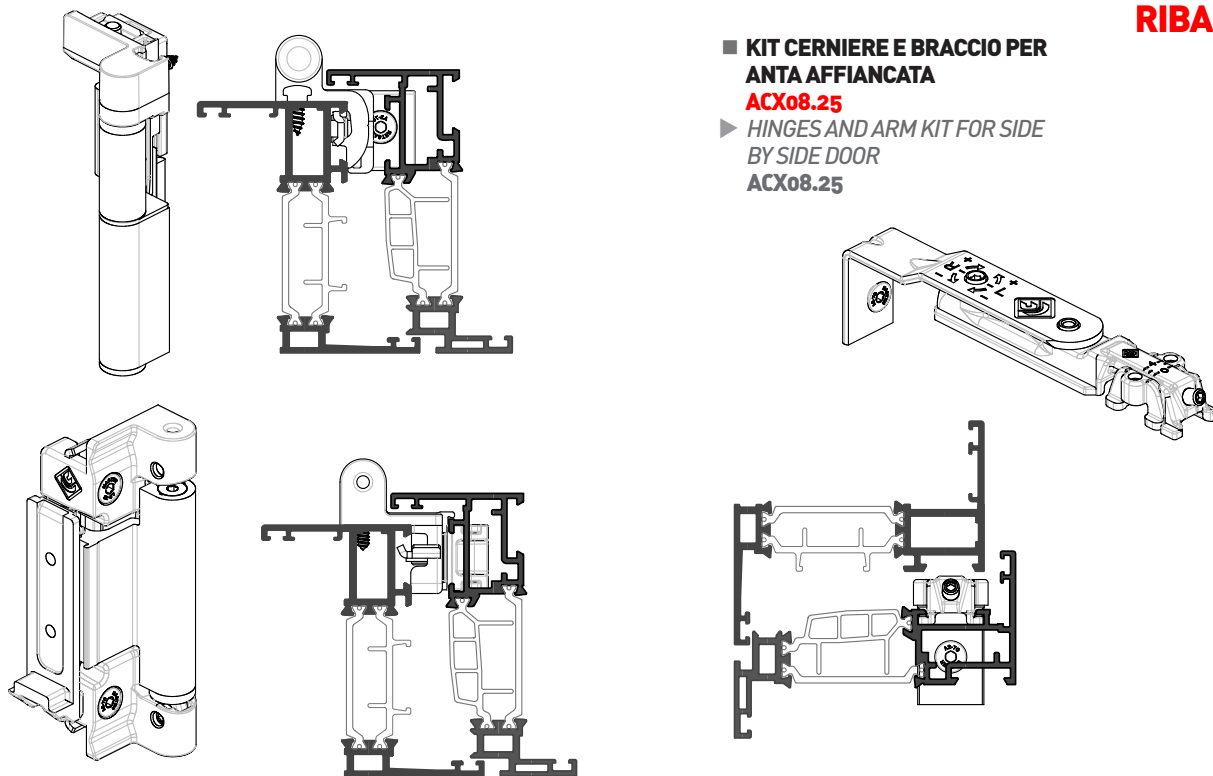

- **"WEEN" BRACCIO LUNGO PER ANTA RIBALTA**  
**ACX08.24**
- ▶ **"WEEN" LONG ARM FOT TILT&TURN DOOR**  
**ACX08.24**

- **"WEEN" BRACCIO MEDIO PER ANTA RIBALTA**  
**ACX08.23**
- ▶ **"WEEN" MEDIUM ARM FOT TILT&TURN DOOR**  
**ACX08.23**

- **"WEEN" BRACCIO CORTO PER ANTA RIBALTA**  
**ACX08.22**
- ▶ **"WEEN" SHORT ARM FOT TILT&TURN DOOR**  
**ACX08.22**

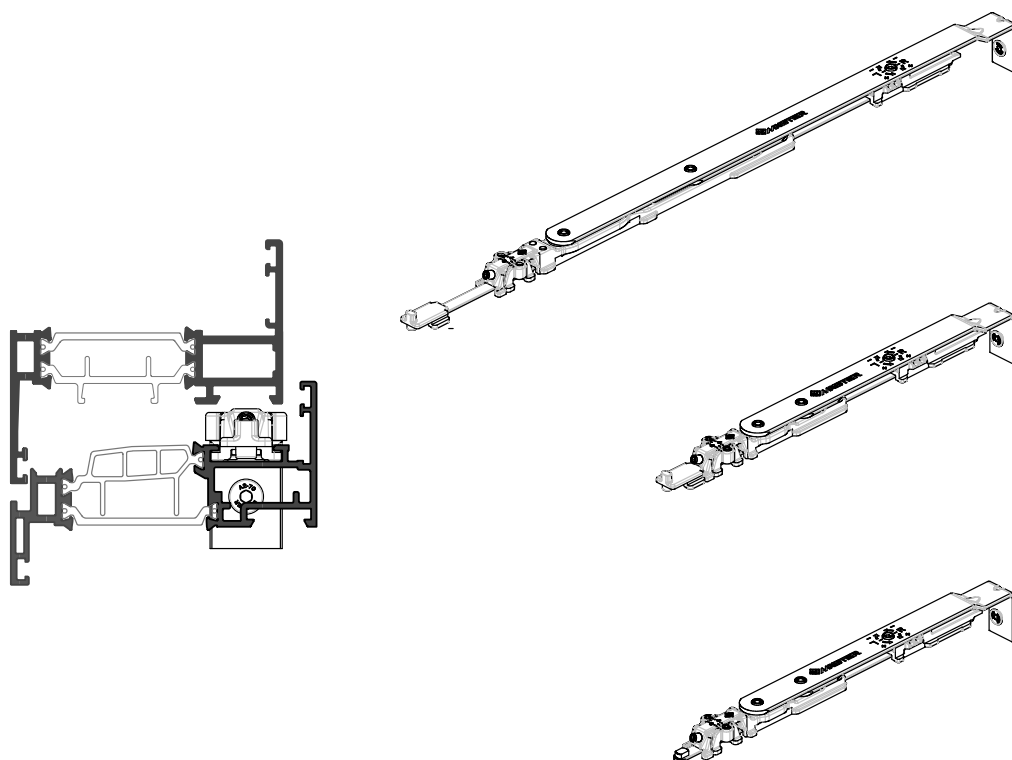



**Applicazione Accessori**  
*Application of Accessories*

**RIBALTA**

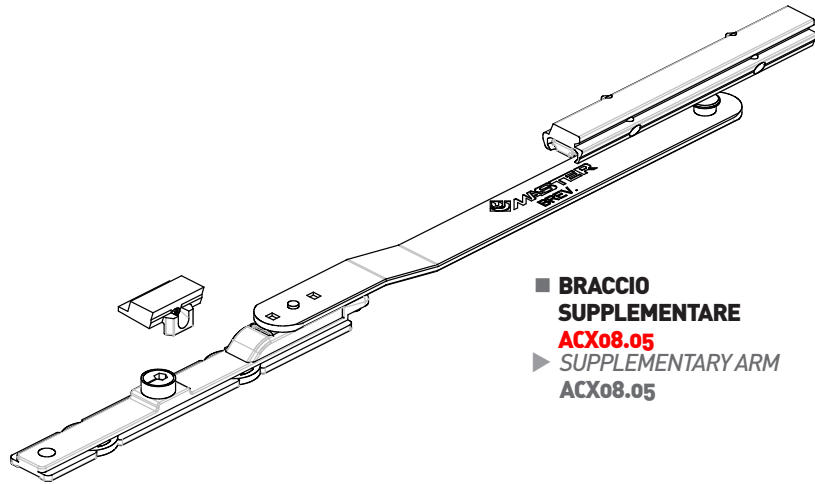
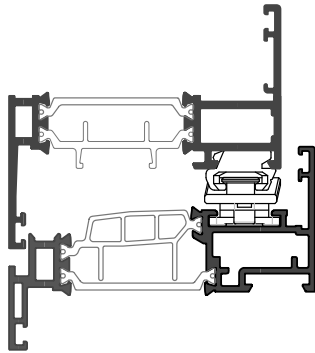

- **BRACCIO SUPPLEMENTARE**  
**ACX08.05**
- ▶ **SUPPLEMENTARY ARM**  
**ACX08.05**

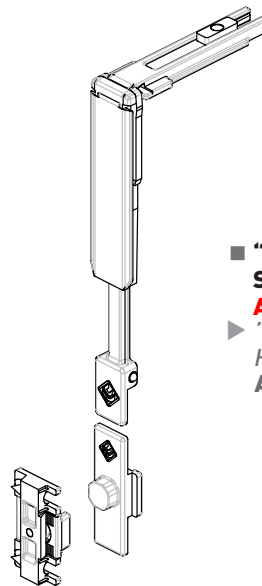
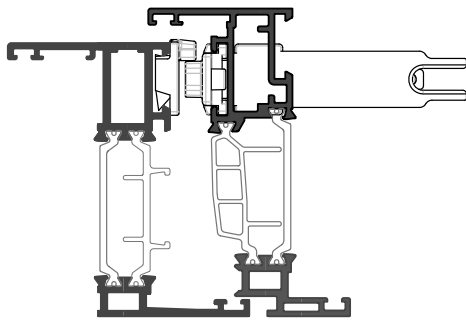

- **"WEEN" CHIUSURA SUPPLEMENTARE ORIZZ/VERT**  
**ACX08.06**
- ▶ **"WEEN" SUPPLEMENTARY HORIZ/VERT ARM**  
**ACX08.06**

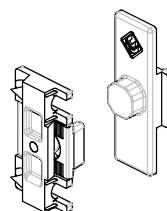
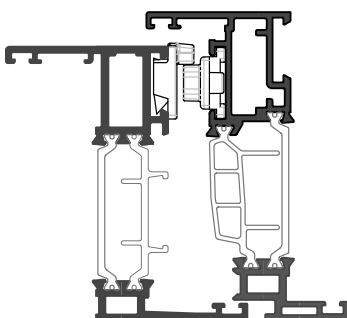

- **"WEEN" PUNTO CHIUSURA SUPPLEMENTARE**  
**ACX08.16**
- ▶ **"WEEN" SUPPLEMENTARY CLOSING POINT**  
**ACX08.16**



**Applicazione Accessori**  
*Application of Accessories*

**RIBALTA**

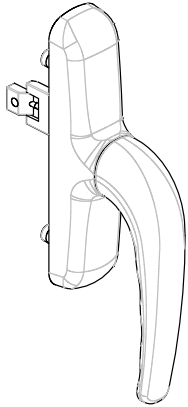

- **CREMONESE PER ANTA A RIBALTA**  
**ARX03.08**
- ▶ **CREMONESE BOLT FOR TILT&TURN DOOR**  
**ARX03.08**

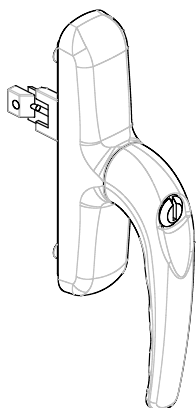
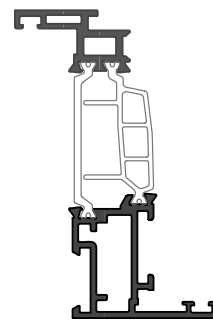
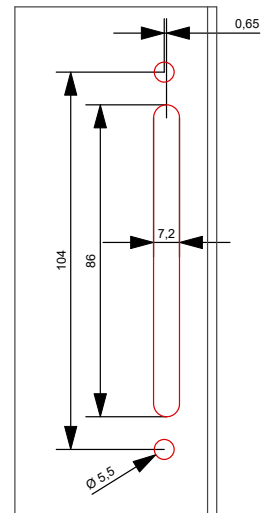
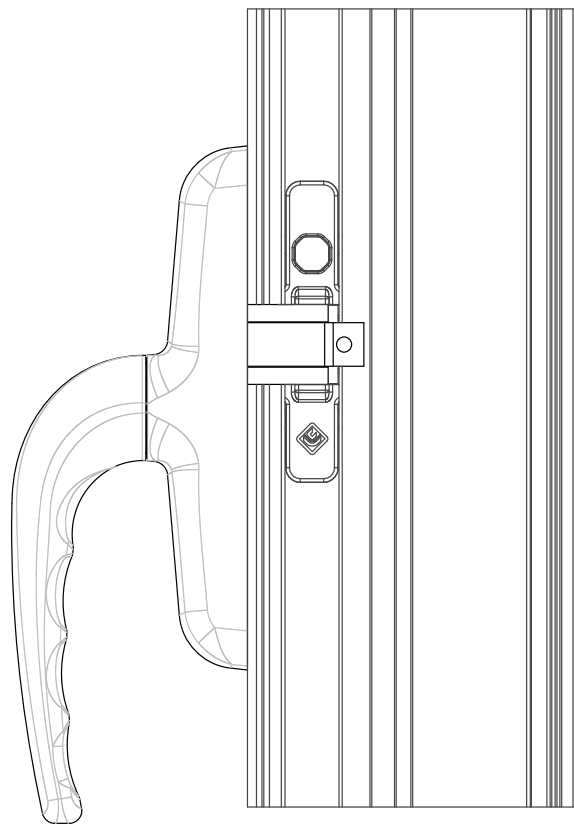

- **CREMONESE CON CHIAVE PER ANTA A RIBALTA**  
**ARX03.46**
- ▶ **CREMONESE BOLT W/CYLINDER LOCK FOR TILT&TURN DOOR**  
**ARX03.46**

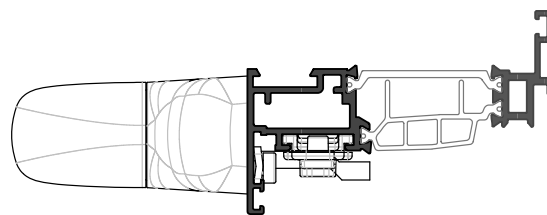



■ **INDICAZIONI PER FORATURA TRAVERSI**

► *INDICATIONS FOR DRILLING CROSSPIECES*

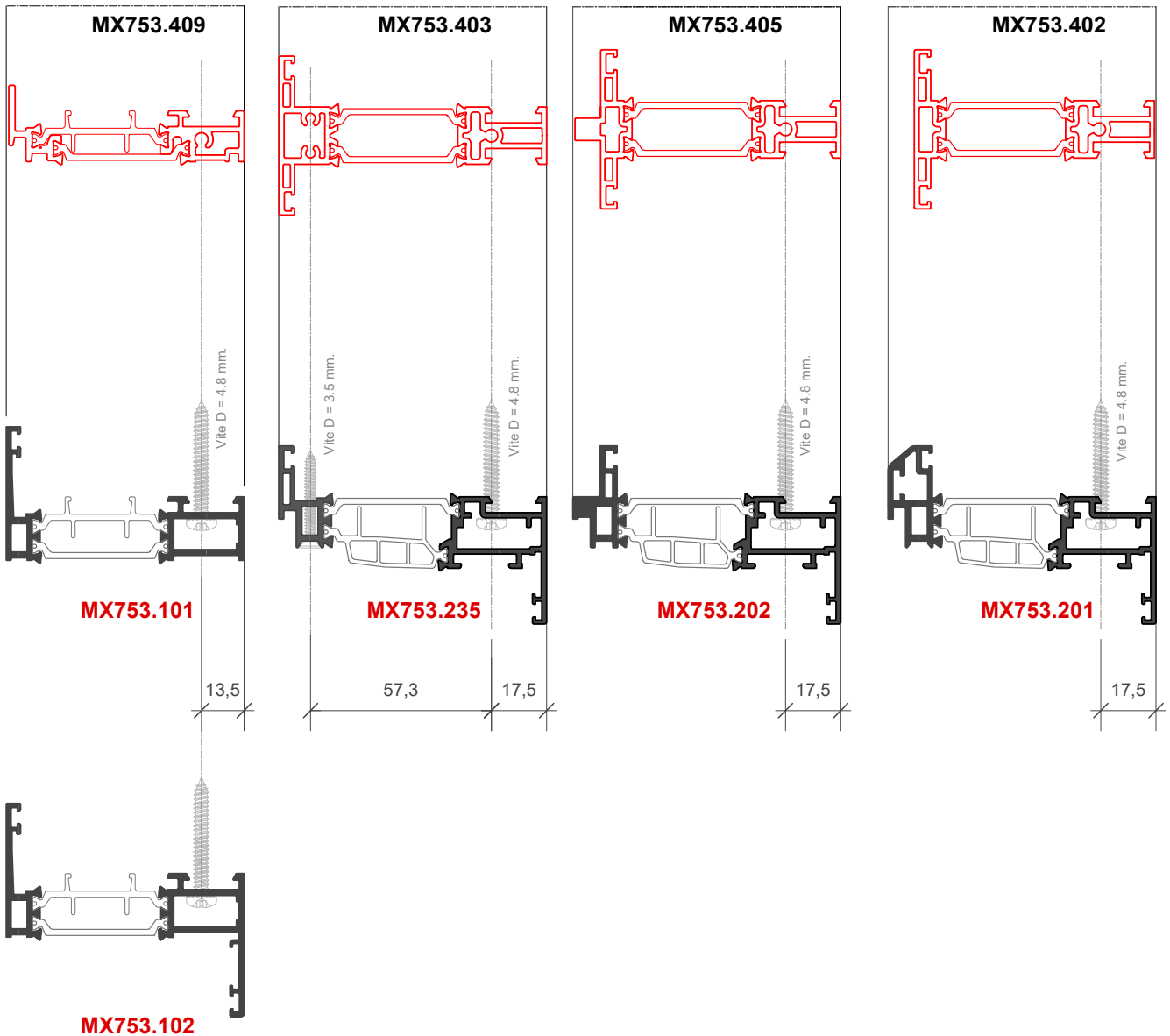



■ **APPLICAZIONE PROFILO**  
**MX603.641**

► **PROFILE APPLICATION**  
**MX603.641**

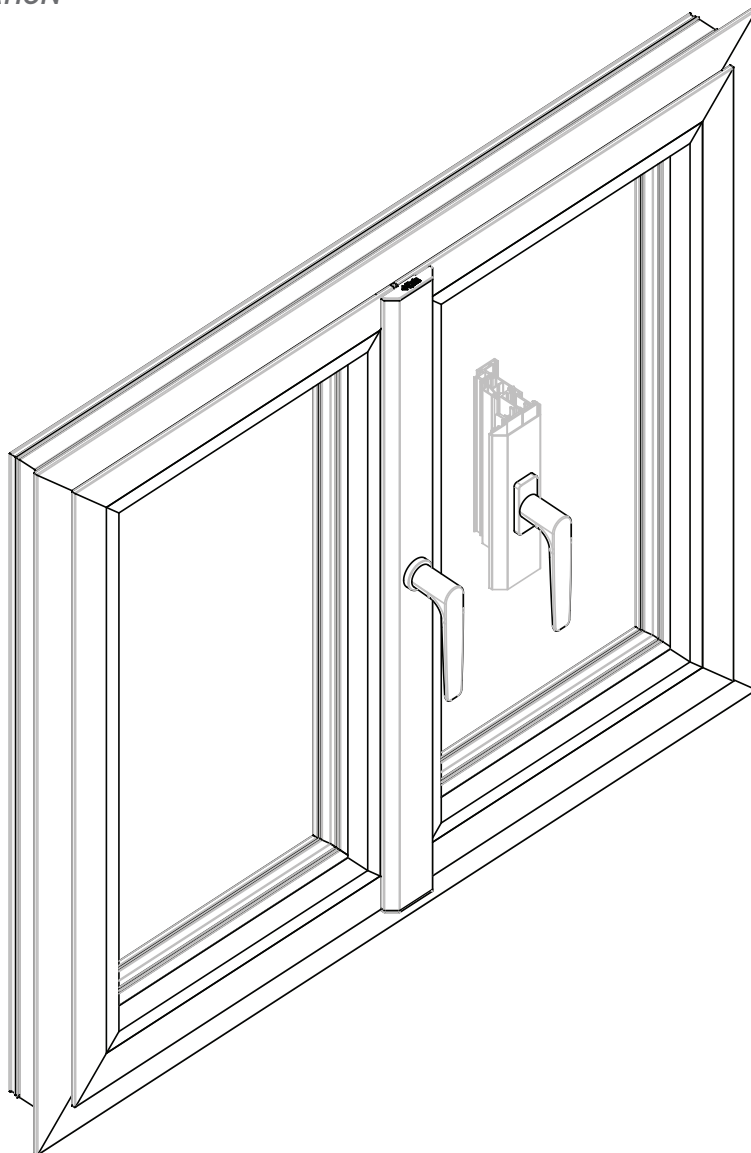

**ACX08.58**

■ **DEVIATORE QUADRO MANIGLIA MINIMAL**  
► **SQUARE DIVERTER MINIMAL HANDLE**

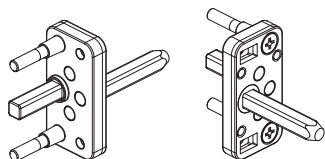

Vista interna

■ **COPPIA DI TAPPI CHIUDI TUBOLARITA'**  
► **PAIR OF TUBULARITY CLOSING WINGS**

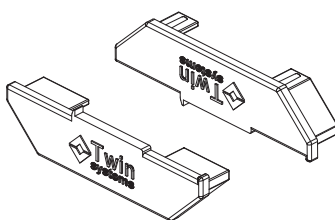

■ **MARTELLINA MINIMAL DESIGN**  
**Sporgenza quadro 17,5-27MM**  
**ACX08.55 | ACX08.57**

► **MARTELLINA HANDLE MINIMAL DESIGN**  
*Square rosette projection*  
**ACX08.55 | ACX08.57**



**ACX08.55**



**ACX08.57**



■ **APPLICAZIONE PROFILO**  
**MX603.641 con ACX08.55**

► **PROFILE APPLICATION**  
**MX603.641 with ACX08.55**

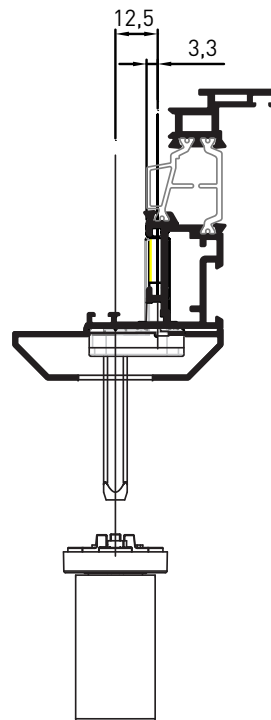
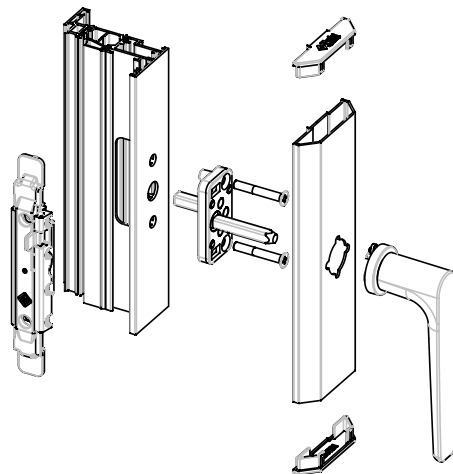

**ACX08.55**



■ **"ITALIA" MARTELLINA MINIMAL DESIGN - Sporgenza quadro 17,5-27MM**  
**ACX08.55**  
► **"ITALIA" MARTELLINA HANDLE MINIMAL DESIGN - Square rosette projec. 17,5-27**  
**ACX08.55**



**NB: Per il montaggio**

■ **Rimuovere il Quadro della maniglia**

**NB: For assembly**

► **Remove the handle follower**

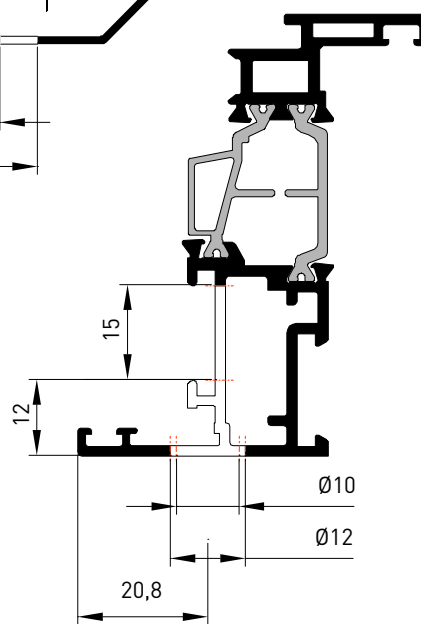
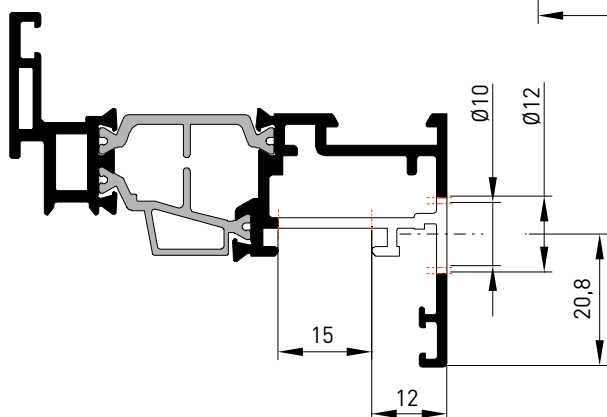
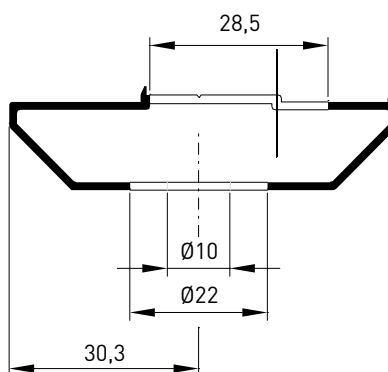
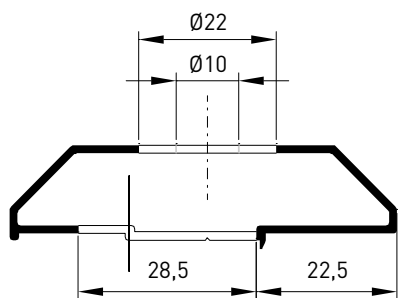



■ **LAVORAZIONE PROFILO**  
**MX603.641 con ACX08.55**

► *PROFILE TOOLING*  
**MX603.641 with ACX08.55**

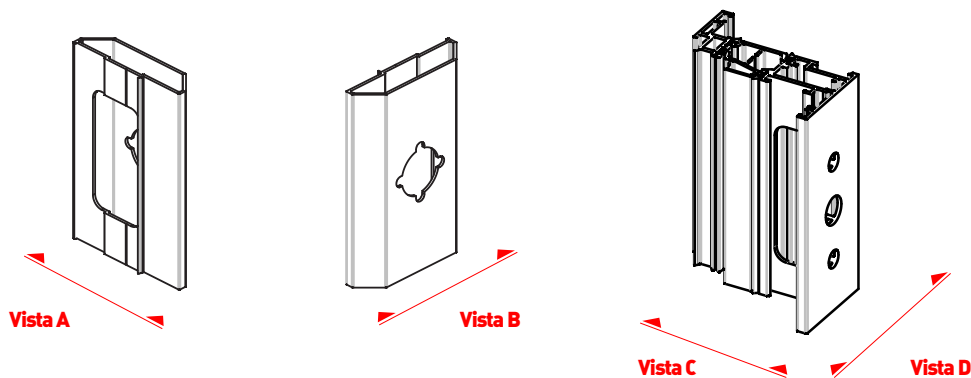
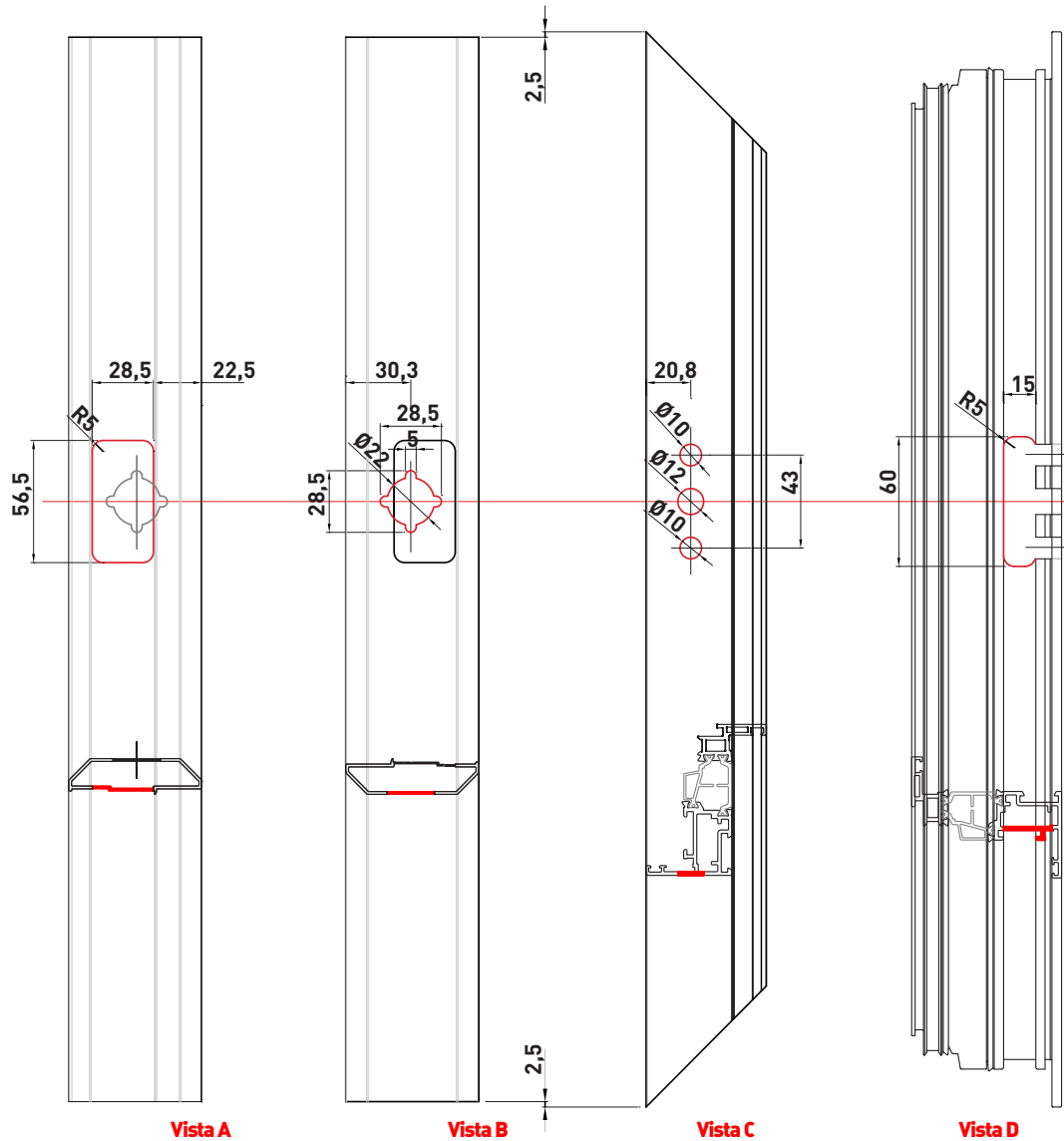



■ **APPLICAZIONE PROFILO**  
**MX603.641 con ACX08.57**

► **PROFILE APPLICATION**  
**MX603.641 with ACX08.57**

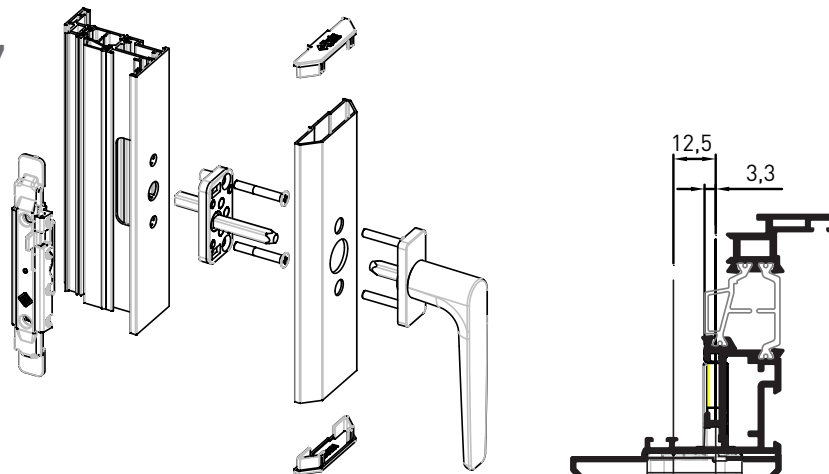

**ACX08.57**



■ **"ITALIA" MARTELLINA MINIMAL DESIGN - Sporgenza quadro 17,5-27MM**  
**ACX08.57**  
► **"ITALIA" MARTELLINA HANDLE MINIMAL DESIGN - Square rosette projec. 17,5-27**  
**ACX08.57**



**NB: Per il montaggio**

- Rimuovere il Quadro della maniglia
- Tagliare le viti in dotazione L=16mm

**NB: For assembly**

- Remove the handle follower
- Cut the screws L = 16mm

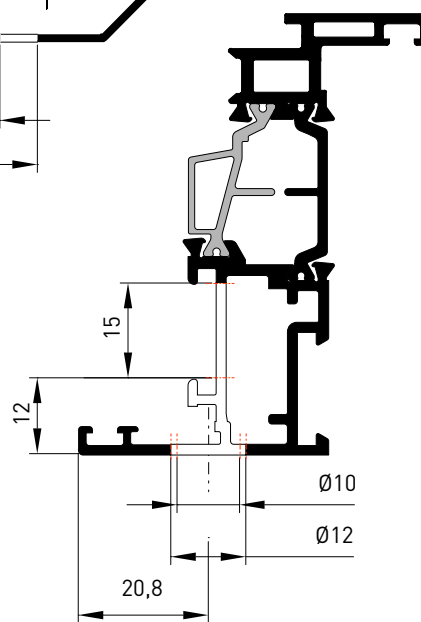
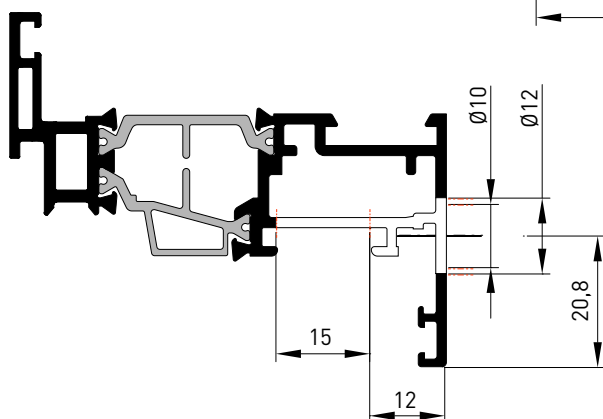
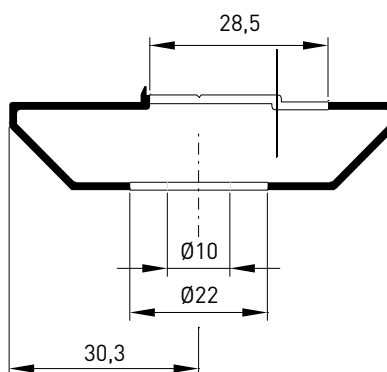
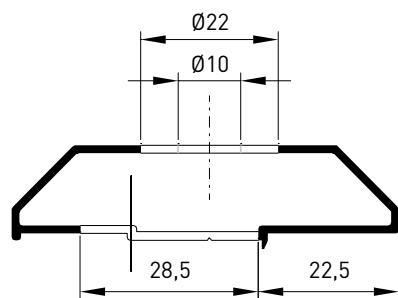
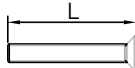





■ **LAVORAZIONE PROFILO**  
**MX603.641 con ACX08.57**  
 ► PROFILE TOOLING  
**MX603.641 with ACX08.57**

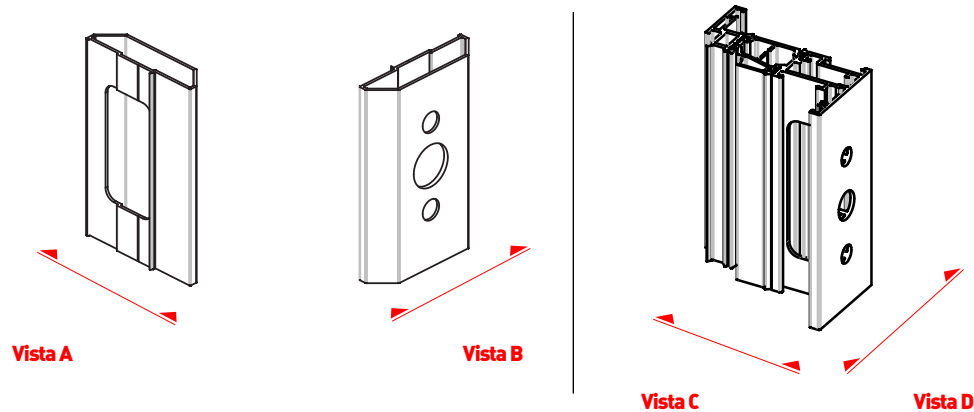
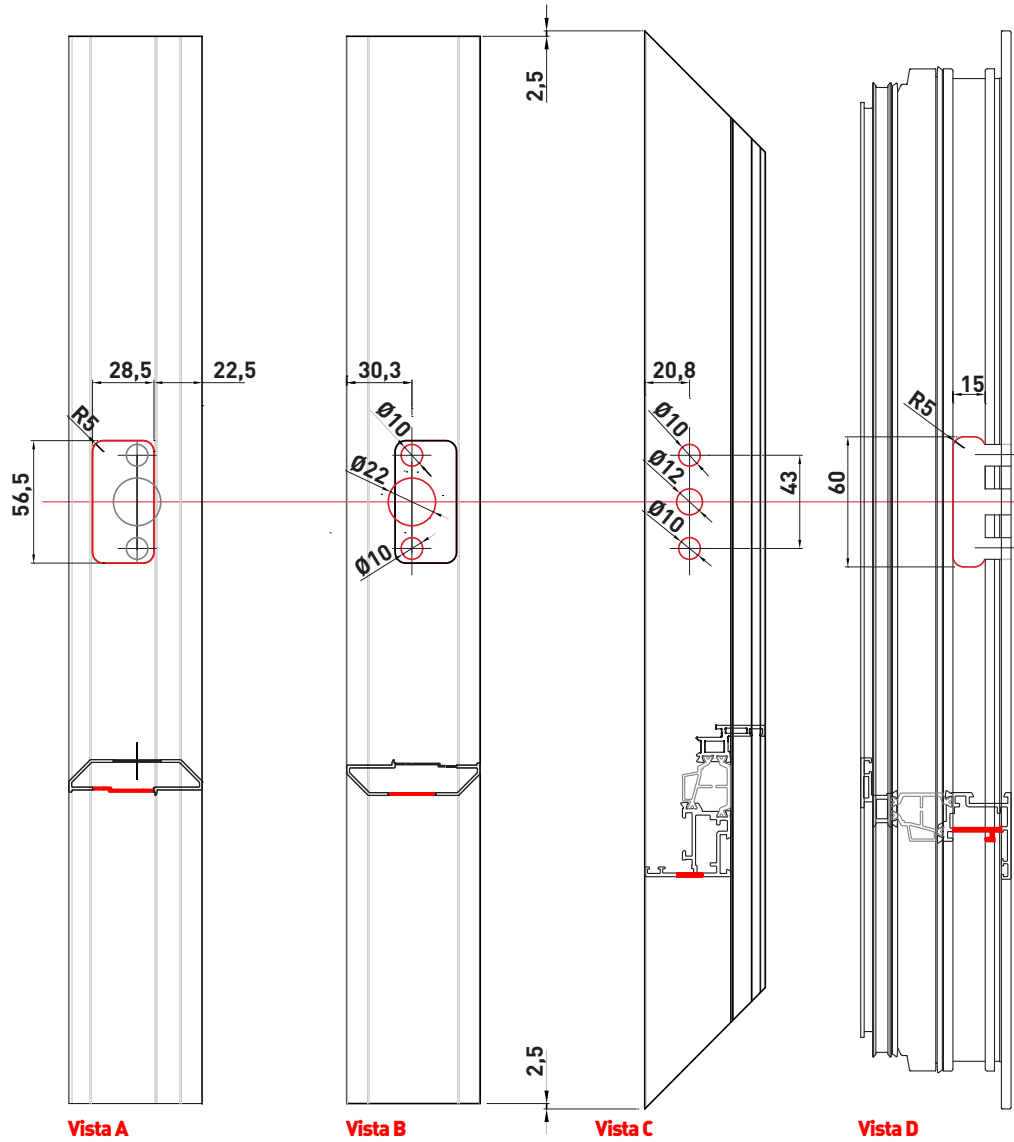



Gli archivi digitali dei prodotti TWIN SYSTEMS  
sono disponibili nei formati:

*The digital files of the TWIN SYSTEMS  
products are available in the formats at:*



[www.twinsystems.it/web/richiesta-dwg](http://www.twinsystems.it/web/richiesta-dwg)

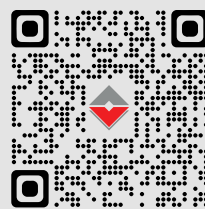

Il presente Catalogo assieme ai cataloghi di tutti i  
prodotti TWIN SYSTEMS sono liberamente scaricabili:

*This Catalog together with the catalogs of all TWIN SYSTEMS  
products can be downloaded freely at:*

[www.twinsystems.it/professionisti/cataloghi/](http://www.twinsystems.it/professionisti/cataloghi/)



**PAGINA** Cataloghi  
**CATALOGUES** Webpage

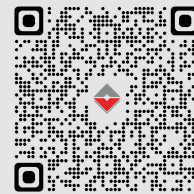

**LINEA** PRODOTTI  
**PRODUCTS** Line

## PAM SYSTEM S.r.L.

S.S. 230 - Fornace Crocicchio 13030 Formigliana (VC)  
Tel. 0161 858811  
www.pamsystemsrl.com | info@pamsystemsrl.com

## ALQ GENOVA s.r.l.

### Genova

Via Colano, 9/A 12/K 16162 Genova Bolzaneto (GE)  
Tel. 010 7491941 - Fax 010 7450155

### Firenze

Via F.lli Cervi 71 50013 Campi Bisenzio (FI)  
Tel. 055 8825060 - Fax 0558824916  
www.alqsystem.it - info@alqgenovasrl.com

## PAESANI GROUP

### Direzione & Magazzino

Via del Grano, 260 47822 Santarcangelo di Romagna (RN)  
Tel. 0541 748511

www.paesani.com - info@paesani.com

### Magazzino Nord

Via Luigi Bonati, 21 29017 Fiorenzuola d'Arda (PC)  
Tel. 0523 943138  
magazzinonord@paesani.com

## DIVA s.a.s

Via Po, 25 - Z.I. Sambuceto 66020 S.Giovanni Teatino (CH)  
Tel. 085 4405210

www.camel-diva.com | info@camel-diva.com

## EUROALL S.r.l.

Strada Comunale della Mola Saracena, 23 00065  
Fiano Romano (RM)  
Tel. 0765 455228/61

www.euroallsl.it - info@euroallsl.it

## PROFILATI UMBRIA S.r.l.

Via Dei Tigli, 35 - 06083 Bastia Umbra (PG)  
Tel. 075 8012385-075 8010328  
profilatiumbria@virgilio.it

## TSL ALLUMINIO S.r.l.

Via delle Industrie, 12 00030 San Cesareo (Roma)  
Tel. 06 2251591 (Ric. Aut.)  
www.tslalluminio.it - info@tstalluminio.it

## ALLCAR SERVICE S.r.l.

Via Acuto, 120 - 00131 Roma  
Tel. 06 4130626 (Ric. Aut.)  
allcarservice@mclink.it

## ALLUCOM S.r.l.

### Andria

Via Vecchia Barletta 237 Z. Ind. - 76123 Andria (BT)  
Tel. 0883 592213

### Bari

Via Zippitelli, 28/B - 70123 (BA)  
Tel. 0805058608  
www.allucom.com - info@allucom.com

## CARUSO S.r.l.

Z.I. Contrada Le Macere 86019 Vinchiaturo (CB)  
Tel. 0874 340024  
carusosrl1@libero.it

## CAIMAR S.n.c.

### Direzione & Magazzino

Strada Prov.le Rimedio-Torregrande Km. 4  
09072 Cabras (OR) - Tel. 0783 290118

### Filiale

Fronte S.S. 131 Km. 17,450 - 09023 Monastir (CA)  
Tel. 070 9166020  
www.caimar.it - caimarmail@caimar.it

## SALENTO METALLI S.r.l.

Via Federico II, 13 - Zona PIP - 73020 Cavallino (LE)  
Tel. 0832 614576  
www.salentometalli.it - info@salentometalli.it

## MIDA ALLUMINIO S.r.l.

### Napoli

Via Piano del Principe, 36  
80047 San Giuseppe Vesuviano (NA)  
Tel. 081 5297373

### Salerno

Loc. Terzerie, Z.I. - 80061 Ogliastro Cilento (SA)  
Tel. 0974 833233  
www.gruppomida.it - info@gruppomida.it

## ITALBACOLOR S.r.l.

C.da Valle S. Maria - 87024 Fuscaldo (CS)  
Tel. 0982 618025  
www.italbacolor.it commerciale@italbacolor.it

## COMAS S.r.l.

Via Porta Palermo, 84 - 91011 Alcamo (TP)  
Tel. 0924 507050 - 0883 592213  
www.comasgroup.it - info@comasgroup.it

## ALUK TIM

### Aluk Tim D.o.o.

Žegoti 10, 51215 Kastav Croazia, UE  
Tel: +385 (0) 51/691 461

### Filiale di Zagabria

Franje Lučića, 34A Zagabria Croazia, UE  
Tel: +385 (0) 1 6462 611 | Mob: +385 (0) 99 2939656  
zagreb@aluk.hr

### Filiale Spalato

Street Sv. Nikole Tavelića, 13A 21204  
Dugopolje Croazia, UE  
Tel: +385 (0) 21225525 |  
Mob: +385 (0) 99 2199228  
split@aluk.hr



  [www.twinsystems.it](http://www.twinsystems.it)  
[info@twinsystems.it](mailto:info@twinsystems.it)

Consorzio **TWIN SYSTEMS**  
Via delle Macere, 20 | 00060 Formello [Roma]  
Tel./Fax 06 23260298