

CX450

FINESTRE A BATTENTE
CASEMENT WINDOWS



TWIN
SYSTEMS

ARCHITETTURE IN ALLUMINIO

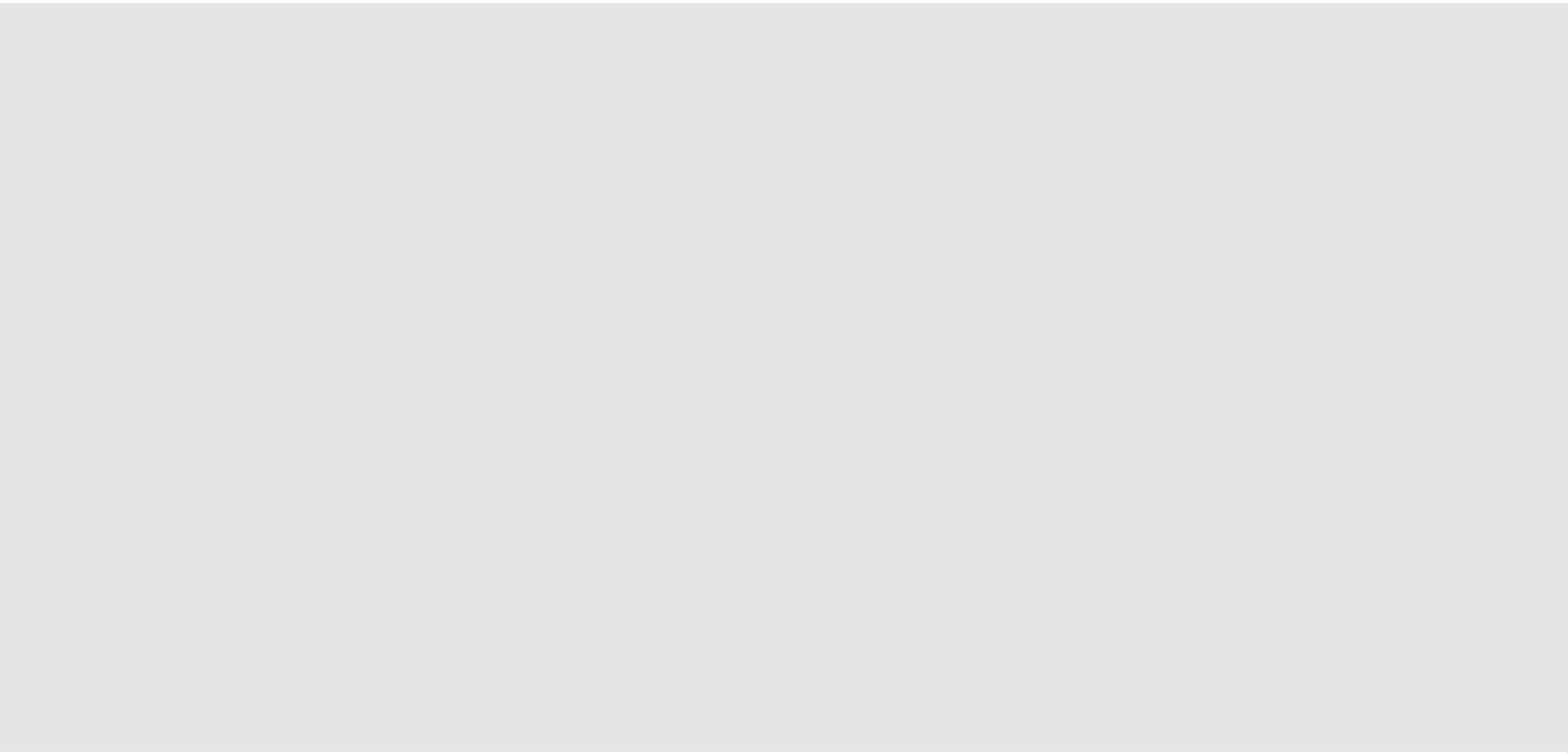

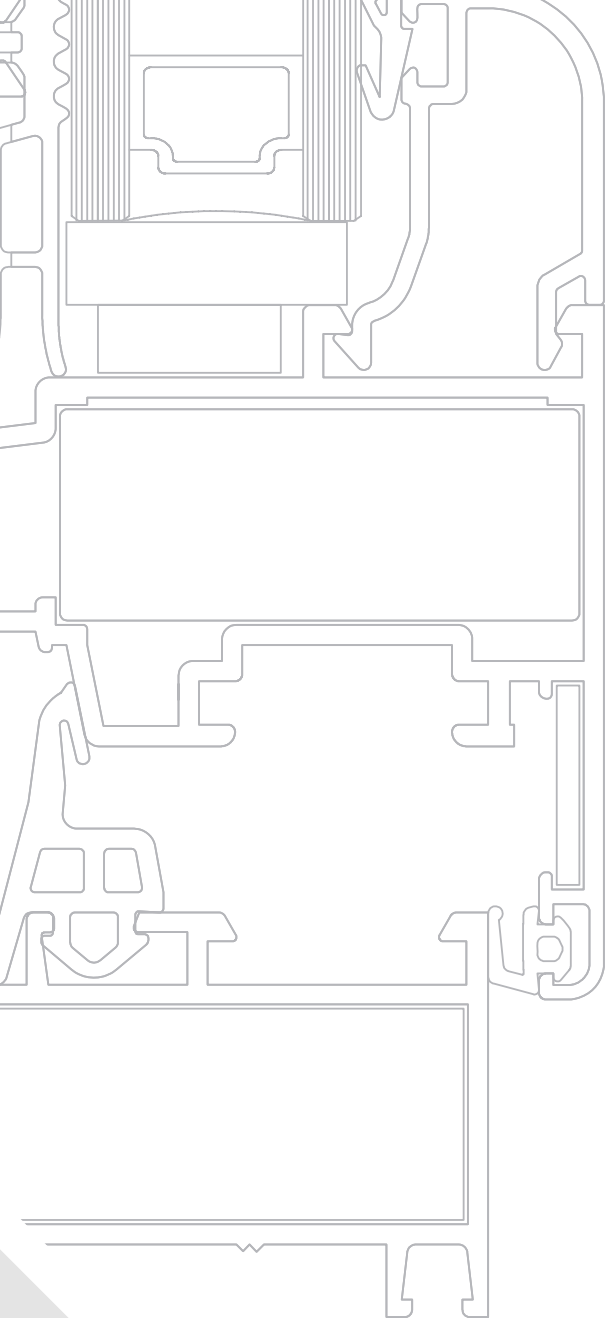

CX450

FINESTRE A BATTENTE
CASEMENT WINDOWS





Gruppo A
Informazioni Generali
General Information

Caratteristiche Alluminio | *Aluminum Features*
Descrizione Tecnica Sistema | *System Tech. Description*
Descrizione Tecnica Capitolato | *Tech. Description Specs*
Collaudi Prestazionali | *Technical Performance Tests*

Gruppo B
Profilati
Profiles

Elenco profilati | *Profiles List*
Profilati scala | *Profiles*
1:1 | *Scale 1:1*

Gruppo C
Accessori e Guarnizioni
Accessories and Gaskets

Elenco accessori | *Accessories List*
Elenco guarnizioni | *Gaskets List*
Accessori Avvolgibile | *Rolling Shutters Accessories*

Gruppo D
Nodi
Sections

Nodi principali | *Main Sections*
in scala 1:1 | *w/Accessories*
con relativi accessori | *Scale 1:1*

Gruppo E
Tipologie
Typologies

Principali tipologie di | *Main types of*
finestre | *windows*

Gruppo F
Collegamento Muratura
Wall Joint

Sezione particolareggiata | *Wall Joint Detail*
attacco alla muratura

Gruppo G
Lavorazioni/Montaggi
Processing/Assembly

Schemi Lavorazioni | *Processing Schemes*
Frese | *Mills*
Attrezzature | *Equipment*

Tutti i dati riportati sul presente catalogo sono indicativi e non impegnativi. La società si riserva il diritto di apportare in qualsiasi momento modifiche atte a migliorare i prodotti. Per informazioni tecniche riguardanti il catalogo contattare l'ufficio tecnico .

All the data shown in this catalog are indicative and not binding. The company reserves the right to make changes to improve the products at any time. For technical information regarding the catalog, contact the technical department.



**TWIN
SYSTEMS**

ARCHITETTURE IN ALLUMINIO



Note Generali
General Info

Gruppo A

Caratteristiche Alluminio	<i>Aluminum Features</i>
Descrizione Tecnica Sistema	<i>System Tech. Description</i>
Descrizione Tecnica Capitolato	<i>Tech. Description Specs</i>
Collaudi Prestazionali	<i>Technical Performance Tests</i>



DIMENSIONI E TIPOLOGIA DEI SERRAMENTI

La valutazione delle dimensioni dei serramenti, richiede la considerazione di vari fattori quali: il momento d'inerzia dei profilati, le dimensioni e il peso dei tamponamenti (vetri-pannelli), la larghezza e l'altezza delle parti apribili caratteristiche e portate degli accessori, le condizioni e le quantità degli ancoraggi alle opere morte, l'esposizione, ecc... Fattori che sono valutabili e applicabili, grazie alla buona conoscenza dello stato dell'arte, alle informazioni riportate dai cataloghi, manuali tecnici e dalle normative vigenti. Consigliamo, al fine di evitare inutili contestazioni, di consultare il nostro servizio tecnico sistemi, prima di realizzare serramenti che, per dimensione, forma, esposizione e/o altro possono essere ritenuti atipici. Le soluzioni e le combinazioni proposte in questo catalogo, non hanno carattere limitativo, ma presentano solo le situazioni e combinazioni più comunemente riscontrabili nella realtà. Soluzioni e combinazioni diverse, così come l'adozione di componentistica particolare, ad esempio meccanismi per la realizzazione di ante scorrevoli parallele, ante scorrevoli a libro o altro, sono possibili. A questo proposito il nostro servizio tecnico prodotti per l'edilizia può valutare e proporre le soluzioni più idonee.

DIMENSIONS AND TYPES OF WINDOWS

The evaluation of the dimensions of the windows requires the consideration of various factors such as: the moment of inertia of the profiles, the dimensions and weight of the infill panels (glass-panels), the width and height of the opening parts, characteristics and capacities of the accessories, the conditions and quantities of the anchors to the dead works, the exposure, etc ... Factors that can be evaluated and applicable, thanks to a good knowledge of the state of the art, to the information reported in catalogs, technical manuals and current regulations. We recommend, in order to avoid unnecessary disputes, to consult our systems technical service, before making windows that, due to size, shape, exposure and / or other, can be considered atypical. The solutions and combinations proposed in this catalog do not have a limiting character, but only show the situations and combinations most commonly found in reality. Different solutions and combinations, as well as the adoption of particular components, for example mechanisms for the creation of parallel sliding doors, folding sliding doors or other, are possible. In this regard, our construction products technical service can evaluate and propose the most suitable solutions.



PESO PROFILATI

Il peso indicato è quello teorico e potrà variare in funzione delle tolleranze di spessore e dimensionali dei profilati (NORMA UNI EN 12020-2)

LEGA DI ESTRUSIONE

I profilati sono estrusi in lega EN-AW-6060 (UNI EN 573/3)

DIMENSIONI DEI PROFILATI

Le dimensioni indicate sono quelle teoriche, potranno quindi variare in funzione delle tolleranze dimensionali di estrusione (norma UNI EN 12020-2). Questa variabilità che interessa tutti i profilati, può influire, anche se minimamente, sulle dimensioni di taglio e quindi finali del serramento. Anche la verniciatura, aumentando gli spessori, contribuisce a far variare la dimensione dei profilati e, particolarmente, riduce lo spazio nelle sedi di inserimento delle guarnizioni e degli accessori.

DIMENSIONI DI TAGLIO E LAVORAZIONI

Le dimensioni teoriche di taglio e le quote delle lavorazioni indicate nel presente catalogo sono esatte, ovvero matematicamente corrette, in certi casi dovranno, nella pratica, essere adattate in base alla precisione ed al tipo di impostazione delle misure delle macchine utilizzate. È pertanto consigliabile nei primi lavori o nel caso di importanti quantità di serramenti effettuare delle campionature di prova.

PROTEZIONE SUPERFICIALE

Al fine di limitare i processi di corrosione filiforme è importante applicare le seguenti regole:

Utilizzare accessori di assemblaggio in alluminio

Utilizzare viti in acciaio inox

Proteggere le parti tagliate e lavorate con prodotti idonei

Evitare ristagni di condense all'interno dei profilati.

Per la realizzazione di serramenti è necessario attenersi alla tecnologia costruttiva e utilizzare le guarnizioni e gli accessori originali riportati sul catalogo tecnico e al rispetto delle norme, prescrizioni e raccomandazioni vigenti. L'osservanza di quanto sopra determina la garanzia. Su queste basi sono stati realizzati campioni che, collaudati in laboratorio hanno ottenuto i risultati indicati nelle certificazioni. Per il buon funzionamento e la durata degli infissi realizzati con profilati ed accessori del sistema, è necessario effettuare alcune semplici operazioni:

Una buona pulizia, eliminando residui di calce, cemento e/o altro.

È consigliabile peraltro proteggere il manufatto sino al momento della messa in esercizio, lubrificare con olio o grasso neutri le parti in movimento e gli organi di chiusura, controllare il corretto serraggio delle viti e dei grani, controllare gli assetti, registrandoli laddove sono previste regolazioni.

Si raccomanda di effettuare queste operazioni almeno con cadenza semestrale. In caso di funzionamento anomalo di qualche componente, evitare assolutamente interventi atti a modificarne le caratteristiche e la sostituzione con ricambi non originali. Ci sembra utile ricordare che interventi di regolazione e/o sostituzione, con particolare riferimento ai meccanismi per oscillo-battente, andranno eseguiti da personale specializzato. Si raccomanda inoltre, in occasione delle operazioni di pulizia, di non utilizzare detergenti che possano deteriorare i trattamenti superficiali, escludendo tassativamente acidi, solventi, materiali abrasivi, spazzole metalliche o comunque in grado di scalfire le superfici, pagliette metalliche e altro.

WEIGHT OF PROFILES

The indicated weight is the theoretical one and may vary according to the thickness and dimensional tolerances of the profiles (UNI EN 12020-2 STANDARD)

EXTRUSION ALLOY

The profiles are extruded in EN-AW-6060 alloy (UNI EN 573/3)

DIMENSIONS OF THE PROFILES

The dimensions indicated are the theoretical ones, and may therefore vary according to the dimensional tolerances of extrusion (UNI EN 12020-2 standard). This variability, which affects all the profiles, can affect, even if minimally, the cutting and therefore final dimensions of the window frame. Even the painting, by increasing the thickness, helps to vary the size of the profiles and, in particular, reduces the space in the seats for inserting the gaskets and accessories.

DIMENSIONS OF CUTTING AND PROCESSING

The theoretical cutting dimensions and the machining dimensions indicated in this catalog are exact, that is mathematically correct, in some cases they must, in practice, be adapted according to the precision and type of setting of the measures of the machines used. It is therefore advisable to carry out test samples in the first works or in the case of large quantities of windows.

SURFACE PROTECTION

In order to limit filiform corrosion processes it is important to apply the following rules:

Use aluminum assembly accessories.

Use stainless steel screws

Protect the cut and machined parts with suitable products

Avoid stagnation of condensation inside the profiles.

For the construction of windows and doors it is necessary to comply with the construction technology and use the original gaskets and accessories shown in the technical catalog and to comply with the standards, prescriptions and recommendations in force. Observance of the above determines the guarantee. On these bases, samples were made which, tested in the laboratory, obtained the results indicated in the certifications. For the proper functioning and duration of the frames made with profiles and accessories of the system, it is necessary to carry out some simple operations:

A good cleaning, eliminating residues of lime, cement and / or other.

It is also advisable to protect the product until the moment of commissioning, lubricate the moving parts and the closing devices with neutral oil or grease, check the correct tightening of the screws and dowels, check the settings, adjusting them where adjustments are required.

It is recommended to carry out these operations at least every six months. In case of anomalous functioning of any component, absolutely avoid interventions aimed at modifying its characteristics and replacing it with non-original spare parts. It seems useful to remember that adjustment and / or replacement interventions, with particular reference to swing-swing mechanisms, must be carried out by specialized personnel. It is also recommended, during cleaning operations, not to use detergents that may deteriorate the surface treatments, strictly excluding acids, solvents, abrasive materials, metal brushes or in any case able to scratch surfaces, steel wool and more.



DESCRIZIONE TECNICA PER CAPITOLATO

TECHNICAL DESCRIPTION

COMPOSIZIONE FISICA

I profilati per serramenti saranno in lega di alluminio ENAW 6060 (EN 573-3 e EN 755-2) con stato fisico di fornitura UNI EN 515

PHYSICAL COMPOSITION

The profiles for doors and windows will be in ENAW 6060 aluminum alloy (EN 573-3 e EN 755 -2) with physical state of supply UNI EN 515

INFISSI

Le finestre e le porte finestre dovranno avere un profilato di telaio fisso con profondità minima 45 o 53 mm. ed un profilato di anta mobile con profondità minima 45 o 53 mm.

I profilati di telaio fisso dovranno prevedere, dove necessario, alette incorporate di battuta interna sulla muratura da 22 mm

. I profilati di ante mobili dovranno avere un'aletta esterna di battuta per vetro con altezza di 22 mm ed una aletta di battuta interna sul telaio fisso con sormonto di 8 mm.

WINDOWS

Windows and French windows must have a fixed frame profile with a minimum depth of 45 or 53 mm. and a mobile leaf profile with a minimum depth of 45 or 53 mm.

The fixed frame profiles must include, where necessary, built-in internal rebate fins on the masonry of 22 mm. The profiles of movable doors must have an external rabbet flap for glass with a height of 22 mm and an internal rabbet flap on the fixed frame with an 8 mm overlap.

DRENAGGI E VENTILAZIONE

I profilati esterni delle ante mobili dovranno prevedere una gola ribassata per la raccolta delle acque di infiltrazione e di condensa onde poter permettere il libero deflusso delle stesse attraverso apposite asole di scarico.

Le barrette in poliammide dovranno avere una conformazione geometrica atta ad evitare eventuale ristagno di acque di infiltrazione e di condensa ed essere perfettamente complanari con le pareti trasversali dei profilati di alluminio.

DRAINAGE AND VENTILATION

The external profiles of the movable doors must have a lowered groove for the collection of infiltration and condensate water in order to allow the free flow of the same through special drain slots.

The polyamide bars must have a geometric conformation suitable to avoid any stagnation of infiltration and condensation water and be perfectly coplanar with the transversal walls of the aluminum profiles.

ACCESSORI DI ASSEMBLAGGIO

Le giunzioni tra profilati orizzontali e verticali dovranno essere perfettamente solidali e ben allineate tra di loro, sia nella parte esterna che interna dei profilati ed unite mediante apposite squadrette a bottone o, in alternativa, in alluminio estruso o pressofuso, con metodo a spino-cianfrinatura od a cianfrinatura totale. Le sezioni dei profilati orizzontali e verticali dovranno essere opportunamente sigillate prima di essere unite con le squadrette. I fermavetri saranno accoppiati a scatto e posizionati nei canali dei profilati in alluminio.

ASSEMBLY ACCESSORIES

The junctions between horizontal and vertical profiles must be perfectly integral and well aligned with each other, both in the external and internal part of the profiles and joined by means of special button brackets or, alternatively, in extruded or die-cast aluminum, with the pin-crimping method or with total crimping. The sections of the horizontal and vertical profiles must be properly sealed before being joined with the brackets. The glazing beads will be snap coupled and positioned in the channels of the aluminum profiles.

GUARNIZIONI

Tutte le guarnizioni: cingivetro, di tenuta, di battuta doppia dovranno essere in elastomero (EPDM).

In particolare la guarnizione di tenuta centrale (giunto aperto) dovrà assicurare la continuità perimetrale mediante l'impiego di angoli vulcanizzati preformati incollati alla stessa o in alternativa mediante telai vulcanizzati.

SEALS

All gaskets: glass, sealing, double rabbet must be in elastomer (EPDM). In particular, the central sealing gasket (open joint) must ensure perimeter continuity through the use of pre-formed vulcanized corners glued to it or alternatively by vulcanized frames.

PRESTAZIONI

I serramenti dovranno avere prestazioni di permeabilità all'aria, tenuta all'acqua e resistenza ai carichi del vento conformemente alle norme : (UNI-EN 12207 - 12208 - 12210 e UNI-EN 1026 - 1027 - 12211)

PERFORMANCE

The windows must have performances of air permeability, water tightness and resistance to wind loads in accordance with the standards: (UNI-EN 12207 - 12208 - 12210 e UNI-EN 1026 - 1027 - 12211)

PERMEABILITÀ ALL'ARIA: CLASSE _____

TENUTA ALL'ACQUA: CLASSE _____

RESISTENZA AL VENTO: CLASSE _____

AIR PERMEABILITY: CLASS _____

WATER RESISTANCE: CLASS _____

WIND RESISTANCE: CLASS _____



DESCRIZIONE TECNICA PER CAPITOLATO PERSIANE

I profilati persiane saranno in lega di alluminio ENAW (EN 573-3 e EN 755-2) con stato fisico di fornitura UNI EN 515

PERSIANE

Il telaio fisso avrà una profondità di mm. 45 (nella soluzione complanare mm. 53), ed una larghezza di mm. 75 (in alternativa mm. 90 o mm. 120).

La sovrapposizione dell'aletta di battuta interna al muro dovrà essere di mm. 25 (in alternativa mm. 40 o mm. 70). Il telaio apribile (anta) avrà una profondità di mm. 53 ed una larghezza di mm. 60, 64, 71, 86 mm.

La cava per inserimento lamelle fisse od orientabili avrà una dimensione di 22.5, 25, 35.3 mm. Il sistema di chiusura è costituito, da una maniglia "tipo cremonese", che comanda l'astina permettendo il movimento per il serraggio dell'anta sul telaio.

Gli accessori di movimentazione delle lamelle sono in materiale opportunamente formulato in modo da poter sopportare sbalzi termici senza ledere la resistenza meccanica.

Il montaggio dei meccanismi avviene senza lavorazioni sui profilati in alluminio.

Sarà possibile la sostituzione delle lamelle danneggiate senza smontare alcun telaio/anta. Nelle ante sarà possibile applicare lo sportello a sporgere.

Gli accessori di portata sono costituiti da cerniere in alluminio estruso con perno di acciaio inserito in una guaina di nylon auto lubrificante e saranno montati e bloccati per contrasto, onde consentire la loro eventuale regolazione e sostituzione.

ACCESSORI

La giunzione degli angoli a 45° viene realizzata mediante l'utilizzo di apposite squadrette in lega di alluminio pressofuso a tirare. Le giunzioni a "T" sono effettuate con viti in acciaio autofilettanti nelle sedi di fissaggio profilo. Le cerniere di alluminio possono essere di colore RAL. Il posizionamento ed il fissaggio delle lamelle fisse, ovaline, è garantito da un sistema detto "tranciato" in alluminio in modo da non avere interruzioni cromatiche tra i vari profili del serramento o con opportuni accessori in materiale plastico denominati selle.

Per i modelli a lamella orientabile, invece, i meccanismi presentano una struttura che garantisce la massima robustezza e l'assoluta resistenza alla corrosione anche in zone marine.

Il colore della movimentazione delle lamelle solitamente è nero. La lamella orientabile presenta una sagomatura a goccia in grado di garantire l'incastro perfetto tra 2 di esse a lamella chiusa: questo evita l'utilizzo di guarnizioni tra lamelle esteticamente poco opportune.

Nel giunto inferiore tra zoccolo e pavimento è possibile montare un profilo porta spazzolino con annesso spazzolino per una tenuta per tutta la larghezza.

GUARNIZIONI

Tutte le Guarnizioni di battuta dovranno essere in elastomero (EPDM)

POSA IN OPERA

Il fissaggio della persiana alle strutture murarie viene eseguito con viti sul contro telaio premurato realizzato con lamiera profilata di acciaio zincato. I fissaggi, preferibilmente, devono distare dagli angoli del telaio non più di mm. 150, e fra loro non più di mm. 800. I fissaggi, preferibilmente, devono distare dagli angoli del telaio non più di mm. 150, e fra loro non più di mm. 800.

PRESTAZIONI

Le prove di certificazione delle persiane dovranno essere conformi alle normative: (UNI-EN 13659:2009, UNI-EN 1932:2002, UNI-EN 13527:2001).

TECHNICAL DESCRIPTION FOR SHUTTER SPECIFICATIONS

The shutter profiles will be in ENAW aluminum alloy (EN 573-3 and EN 755-2) with physical state of supply UNI EN 515

SHUTTERS

The fixed frame will have a depth of mm. 45 (in the coplanar solution mm. 53), and a width of mm. 75 (alternatively 90 mm or 120 mm). The overlap of the internal stop flap to the wall must be mm. 25 (alternatively 40 mm or 70 mm). The opening frame (door) will have a depth of mm. 53 and a width of mm. 60, 64, 71, 86 mm. The slot for inserting fixed or adjustable slats will have a size of 22.5, 25, 35.3 mm. The closing system consists of a "Cremonese type" handle, which controls the rod allowing the movement to tighten the door on the frame. The accessories for moving the slats are made of suitably formulated material so as to be able to withstand thermal changes without affecting the mechanical strength. The assembly of the mechanisms takes place without machining on the aluminum profiles. It will be possible to replace damaged slats without disassembling any frame / door. In the doors it will be possible to apply the protruding door. The range accessories consist of extruded aluminum hinges with a steel pin inserted in a self-lubricating nylon sheath and will be mounted and locked by contrast, in order to allow their eventual adjustment and replacement.

ACCESSORIES

The junction of the corners at 45° is achieved through the use of special brackets in die-cast aluminum alloy to pull. The "T" joints are made with self-tapping steel screws in the profile fixing seats. The aluminum hinges can be of RAL color. The positioning and fixing of the fixed slats, oval, is guaranteed by a system called "sheared" in aluminum so as not to have chromatic interruptions between the various profiles of the window or with appropriate accessories in plastic material called saddles. For the adjustable reed models, however, the mechanisms have a structure that guarantees maximum strength and absolute resistance to corrosion even in marine areas. The color of the movement of the slats is usually black. The adjustable slat has a drop shape able to ensure the perfect fit between 2 of them with closed slats: this avoids the use of gaskets between aesthetically inappropriate slats. In the lower joint between the plinth and the floor it is possible to mount a toothbrush holder profile with attached brush for a seal along the entire width.

GASKETS

All the stop gaskets must be in elastomer (EPDM)

INSTALLATION

The fixing of the shutter to the wall structures is carried out with screws on the premade subframe made with profiled galvanized steel sheet. The fixings, preferably, should be no more than mm away from the corners of the frame. 150, and between them not more than mm. 800. The fixings, preferably, must be no more than mm. 800. Away from the corners of the frame. 150, and between them not more than mm. 800.

PERFORMANCE

The certification tests of the shutters must comply with the regulations: (UNI-EN 13659: 2009, UNI-EN 1932: 2002, UNI-EN 13527: 2001).

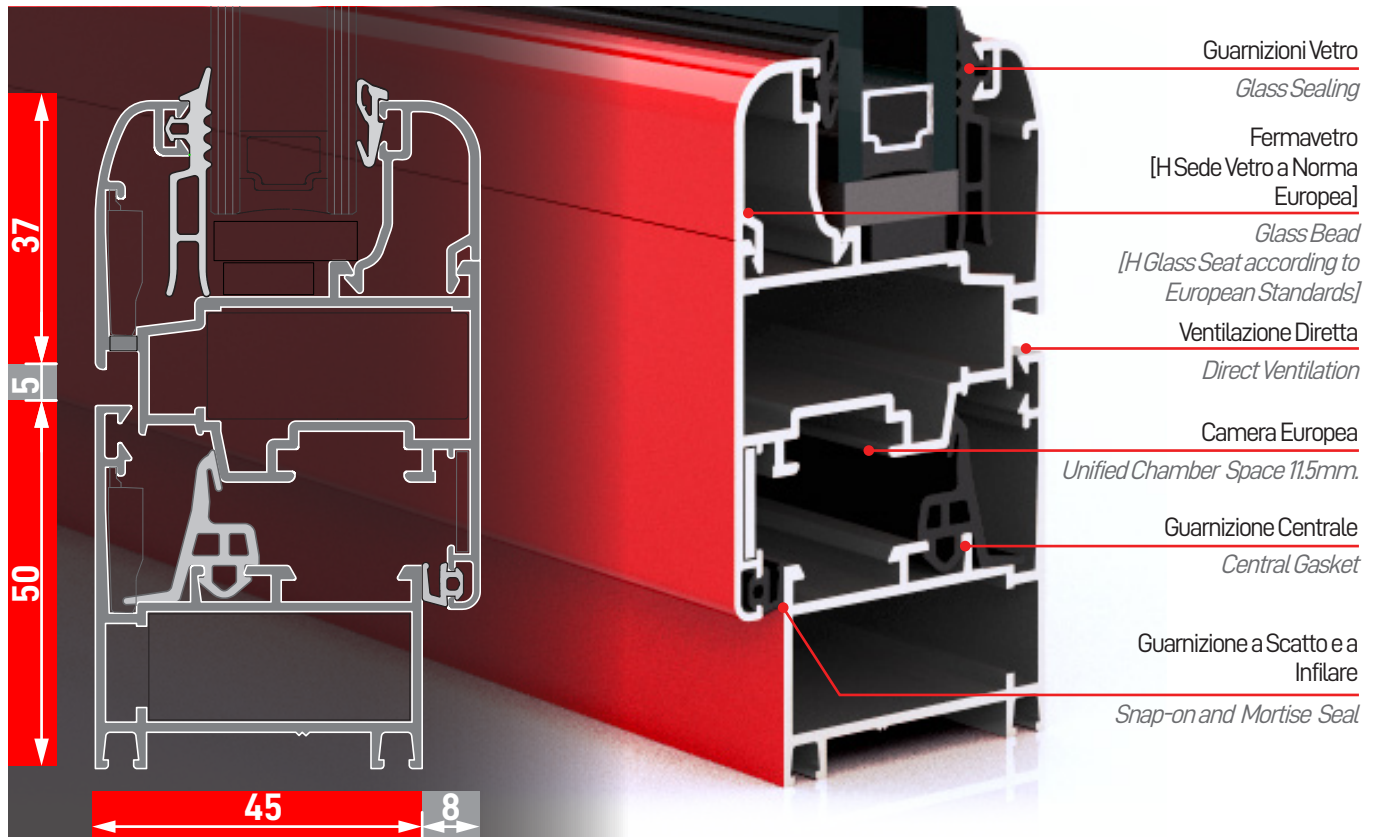

Profilati estrusi lega | Extruded Profiles Alloy: ENAV 6060 [EN 573 - 3]

Stato di Fornitura | Temper: T5 (EN 752 - 2)

Tolleranze Dimensioni Spessori | Width Tolerances: EN 755 - 9

Tipo di tenuta aria/acqua: Finestre: Guarnizione Centrale (Giunto Aperto) | Porte: Doppia Battuta
Seal Type: Windows: Central Gasket (Open Joint) | Doors: Double Rabbet

Inserimento del vetro: Fermavetro a scatto sia rettangolare che arrotondato.
Glass Insertion: Snap Stop Glass Bead both Round and Squared Design

Altezza Utile Alloggiamento Vetro: 22 mm Possibilità di inserimento Volumi di Vetro o Pannelli con Spessori Variabili tra 4 e 40mm.
Useful Height Glass Housing: 22 mm Possibility of inserting Glass Volumes or Panels with Variable Thicknesses between 4 and 40mm.

Telaio Fisso: 45 o 53 mm. (Complanare)
Fix Frame: 45 o 53 mm. (Coplanar)

Telaio Mobile: 45 o 53 mm. (Complanare)
Mobile Frame: 45 o 53 mm. (Coplanar)

Controtelaio: 40 mm.
Counterframe: 40 mm.

Fuga perimetrale interna ed esterna: 5 mm.
Internal and External Clearance: 5 mm.

Alloggiamento accessori: Camera Europea Spazio 11.5 mm.
Alloggiamento accessori: Camera Europea Spazio 11.5 mm.

Giunzione angolare: Squadrette
Corner Joint: Metal Joint

IMPIEGO: | USE:

Profilati per finestre che consentono la costruzione di infissi ad una, due o più ante a battente, nella versione agiunto aperto o con doppia guarnizione di battuta complanari all'esterno e a sormonto all'interno. Sono possibili anche specchiature fisse, wasistas, anta-ribalta. Profilati per porte: consentono la costruzione di porte ad una o due ante, apribili sia all'interno che all'esterno, con sopraluci fissi od apribili e vetrine.

Window profiles that allow the construction of window frames with one, two or more hinged doors, in the open joint version or with double rabbet gasket coplanar on the outside and overlapping inside. Fixed mirrors, wasistas, tilt and turn are also possible. Door profiles: allow the construction of doors with one or two doors, which can be opened both inside and outside, with fixed or opening fanlights and display cases.



TWIN
SYSTEMS

ARCHITETTURE IN ALLUMINIO



Profili
Profiles

Gruppo B

Elenco Profili
Profili in Scala
1:1

Profiles List
Scale 1:1

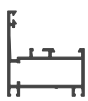

CX45.101			Tavola B 12
Telaio ad L piccolo			
Peso	kg/ml. 0.777		
Jx	4.59 cm ⁴ Wx 1.46 cm ³		
Jy	7.87 cm ⁴ Wy 3.02 cm ³		

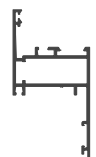
CX45.111			Tavola B 14
Telaio a Z aletta battuta 40 mm.			
Peso	kg/ml. 0.975		
Jx	14.37 cm ⁴ Wx 2.83 cm ³		
Jy	11.40 cm ⁴ Wy 4.78 cm ³		

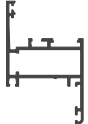
CX45.102			Tavola B 12
Telaio a Z piccolo			
Peso	kg/ml. 0.898		
Jx	7.95 cm ⁴ Wx 2.16 cm ³		
Jy	10.06 cm ⁴ Wy 4.38 cm ³		

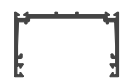
CX45.113			Tavola B 13
Telaio di compensazione			
Peso	kg/ml. 0.801		
Jx	4.28 cm ⁴ Wx 1.68 cm ³		
Jy	17.79 cm ⁴ Wy 5.83 cm ³		

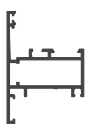
CX45.103			Tavola B 12
Telaio a T piccolo			
Peso	kg/ml. 0.899		
Jx	8.04 cm ⁴ Wx 2.19 cm ³		
Jy	8.96 cm ⁴ Wy 3.17 cm ³		

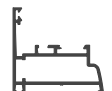
CX45.114			Tavola B 16
Telaio ad L ellittico			
Peso	kg/ml. 0.805		
Jx	4.66 cm ⁴ Wx 1.47 cm ³		
Jy	9.88 cm ⁴ Wy 3.04 cm ³		

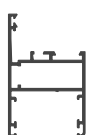
CX45.104			Tavola B 12
Telaio ad h piccolo-soglia			
Peso	kg/ml. 0.974		
Jx	10.55 cm ⁴ Wx 2.79 cm ³		
Jy	11.36 cm ⁴ Wy 4.48 cm ³		

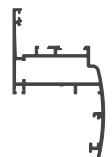
CX45.115			Tavola B 16
Telaio a Z ellittico aletta 40 mm.			
Peso	kg/ml. 1.080		
Jx	17.34 cm ⁴ Wx 3.57 cm ³		
Jy	16.53 cm ⁴ Wy 5.87 cm ³		

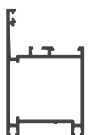
CX45.105			Tavola B 13
Telaio ad L grande			
Peso	kg/ml. 1.026		
Jx	16.49 cm ⁴ Wx 3.87 cm ³		
Jy	11.82 cm ⁴ Wy 4.69 cm ³		

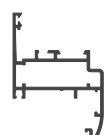
CX45.120			Tavola B 15
Telaio a Z compl. aletta 25 mm.			
Peso	kg/ml. 1.002		
Jx	10.52 cm ⁴ Wx 2.80 cm ³		
Jy	14.60 cm ⁴ Wy 5.45 cm ³		

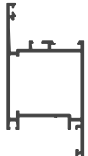
CX45.106			Tavola B 13
Telaio a Z grande			
Peso	kg/ml. 1.127		
Jx	23.71 cm ⁴ Wx 4.86 cm ³		
Jy	13.96 cm ⁴ Wy 6.15 cm ³		

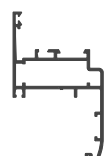
CX45.121			Tavola B 15
Telaio a Z compl. aletta 40 mm.			
Peso	kg/ml. 1.083		
Jx	17.48 cm ⁴ Wx 3.58 cm ³		
Jy	16.30 cm ⁴ Wy 5.82 cm ³		

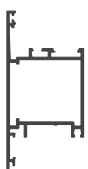
CX45.107			Tavola B 13
Telaio a T grande			
Peso	kg/ml. 1.153		
Jx	24.08 cm ⁴ Wx 4.96 cm ³		
Jy	13.14 cm ⁴ Wy 4.83 cm ³		

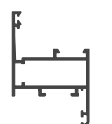
CX45.122			Tavola B 16
Telaio/anta picc. doppia battuta			
Peso	kg/ml. 0.845		
Jx	6.72 cm ⁴ Wx 1.93 cm ³		
Jy	9.39 cm ⁴ Wy 4.06 cm ³		

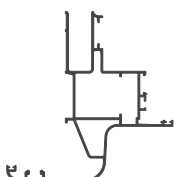
CX45.109			Tavola B 40
Telaio per capannoni			
Peso	kg/ml. 2.610		
Jx	162.17 cm ⁴ Wx 20.44 cm ³		
Jy	83.52 cm ⁴ Wy 12.03 cm ³		



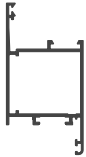

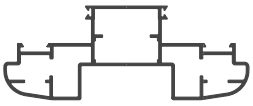
CX45.123			Tavola B 16
Telaio/anta grande doppia batt.			
Peso	kg/ml. 1.064		
Jx	19.55 cm ⁴ Wx 4.86cm ³		
Jy	12.84 cm ⁴ Wy 5.59 cm ³		

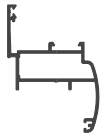
CX45.151			Tavola B18
Telaio Romana Persiana/Finestra			
Peso	kg/ml. 2.144		
Jx	0.00 cm ⁴ Wx 0.00 cm ³		
Jy	0.00 cm ⁴ Wy 0.00 cm ³		

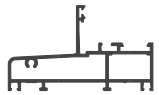
CX45.125			Tavola B19
Telaio per controltelaio 40 mm.			
Peso	kg/ml. 0.906		
Jx	12.82 cm ⁴ Wx 4.75 cm ³		
Jy	9.58 cm ⁴ Wy 2.50 cm ³		

E70.146			Tavola B18
Telaio abb.scorrevole E 700			
Peso	kg/ml. 1.267		
Jx	31.36 cm ⁴ Wx 7.09 cm ³		
Jy	6.02 cm ⁴ Wy 1.77 cm ³		

CX45.132			Tavola B17
Telaio a L piccolo liscio			
Peso	kg/ml. 0.695		
Jx	3.75 cm ⁴ Wx 1.27 cm ³		
Jy	6.76 cm ⁴ Wy 2.55 cm ³		

E70.147			Tavola B18
Telaio abb.scorrevole E 700			
Peso	kg/ml. 1.370		
Jx	0.00 cm ⁴ Wx 0.00 cm ³		
Jy	0.00 cm ⁴ Wy 0.00 cm ³		

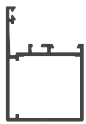
CX45.133			Tavola B17
Telaio a L grande liscio			
Peso	kg/ml. 0.915		
Jx	12.84 cm ⁴ Wx 3.29 cm ³		
Jy	10.34 cm ⁴ Wy 4.04 cm ³		

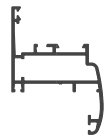
CX45.158			Tavola B19
Telaio a Z ellittico aletta 25 mm.			
Peso	kg/ml. 0.981		
Jx	14.33 cm ⁴ Wx 5.12 cm ³		
Jy	10.24 cm ⁴ Wy 2.71 cm ³		

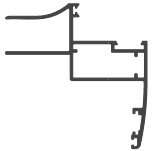
CX45.134			Tavola B35
Telaio porte interne			
Peso	kg/ml. 1.261		
Jx	20.76 cm ⁴ Wx 4.06 cm ³		
Jy	28.82 cm ⁴ Wy 5.52 cm ³		

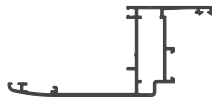
CX45.165			Tavola B19
Telaio a Z aletta battuta 70 mm.			
Peso	kg/ml. 1.207		
Jx	19.07 cm ⁴ Wx 6.06 cm ³		
Jy	40.00 cm ⁴ Wy 5.72 cm ³		

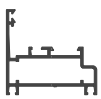
CX45.135			Tavola B15
Telaio a L piccolo complanare			
Peso	kg/ml. 0.837		
Jx	4.80 cm ⁴ Wx 1.50 cm ³		
Jy	10.86 cm ⁴ Wy 3.49 cm ³		

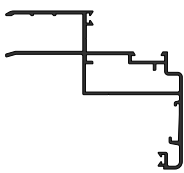
CX45.166			Tavola B15
Telaio per Porte			
Peso	kg/ml. 1.463		
Jx	00,00 cm ⁴ Wx 0,00 cm ³		
Jy	00,00 cm ⁴ Wy 0,00 cm ³		

CX45.139		Solo persiana Only for jalousie window 	Tavola B38
Telaio a Z ellittico aletta 40 mm.			
Peso	kg/ml. 1.073		
Jx	17.32 cm ⁴ Wx 3.55 cm ³		
Jy	16.51 cm ⁴ Wy 5.85 cm ³		

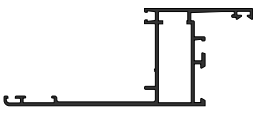
CX45.186			Tavola B17
Telaio Z Aletta 65 mm			
Peso	kg/ml. 1.114		
Jx	00,00 cm ⁴ Wx 0,00 cm ³		
Jy	00,00 cm ⁴ Wy 0,00 cm ³		

CX45.140			Tavola B17
Telaio a L di riporto su tubolare			
Peso	kg/ml. 0.442		
Jx	0,00 cm ⁴ Wx 0,00 cm ³		
Jy	0,00 cm ⁴ Wy 0,00 cm ³		

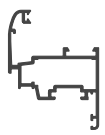
CX45.201			Tavola B20
Anta tonda piccola c/fermavetro			
Peso	kg/ml. 1.005		
Jx	9.30 cm ⁴ Wx 2.64 cm ³		
Jy	13.56 cm ⁴ Wy 5.09 cm ³		



CX45.202		
Anta tonda grande c/fermavetro		
Peso	kg/ml.	1.269
Jx	27.56 cm ⁴	Wx 5.79 cm ³
Jy	19.30 cm ⁴	Wy 7.20 cm ³



Tavola
B20

CX45.210		
Anta ellittica grande vetro infilare		
Peso	kg/ml.	1.384
Jx	31.19 cm ⁴	Wx 6.44 mm ³
Jy	22.95 cm ⁴	Wy 7.68 mm ³



Tavola
B22

CX45.203		
Anta tonda piccola v/infilare		
Peso	kg/ml.	1.080
Jx	9.73 cm ⁴	Wx 2.68 cm ³
Jy	14.12 cm ⁴	Wy 4.79 cm ³



Tavola
B21

CX45.211		
Anta picc.vetro inf. doppia battuta		
Peso	kg/ml.	0.960
Jx	9.63 cm ⁴	Wx 2.72 mm ³
Jy	10.98 cm ⁴	Wy 4.52 mm ³



Tavola
B23

CX45.204		
Anta tonda piccola f/nastro		
Peso	kg/ml.	1.207
Jx	13.94 cm ⁴	Wx 3.58 cm ³
Jy	17.34 cm ⁴	Wy 6.15 cm ³

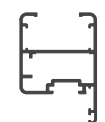

Tavola
B27

CX45.212		
Anta piccola apertura esterna		
Peso	kg/ml.	0.975
Jx	9.53 cm ⁴	Wx 2.51 mm ³
Jy	10.09 cm ⁴	Wy 3.77 mm ³



Tavola
B23

CX45.205		
Anta apertura esterna		
Peso	kg/ml.	1.306
Jx	30.41 cm ⁴	Wx 6.27 cm ³
Jy	18.66 cm ⁴	Wy 5.97 cm ³

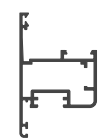

Tavola
B30

CX45.213		
Anta persiana complanare		
Peso	kg/ml.	1.031
Jx	9.46 cm ⁴	Wx 2.63 cm ³
Jy	13.96 cm ⁴	Wy 4.53 cm ³

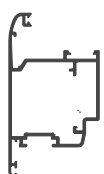

Tavola
B24

CX45.206		
Anta tonda grande v/infilare		
Peso	kg/ml.	1.335
Jx	30.33 cm ⁴	Wx 6.15 cm ³
Jy	20.60 cm ⁴	Wy 7.24 cm ³



Tavola
B21

CX45.214		
Anta grande apertura esterna		
Peso	kg/ml.	1.265
Jx	27.53 cm ⁴	Wx 5.53 cm ³
Jy	14.54 cm ⁴	Wy 5.63 cm ³



Tavola
B23

CX45.207		
Anta apertura bilico		
Peso	kg/ml.	1.383
Jx	33.41 cm ⁴	Wx 6.66 cm ³
Jy	19.32 cm ⁴	Wy 6.02 cm ³

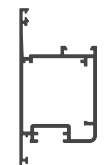

Tavola
B30

CX45.217		
Anta porta interna pann. 40 mm.		
Peso	kg/ml.	0.911
Jx	6.82 cm ⁴	Wx 2.06 cm ³
Jy	12.93 cm ⁴	Wy 4.30 cm ³

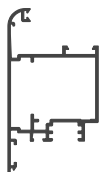

Tavola
B35

CX45.208		
Anta persiana complan. ellittica		
Peso	kg/ml.	1.102
Jx	10.32 cm ⁴	Wx 2.88 cm ³
Jy	16.86 cm ⁴	Wy 5.13 cm ³

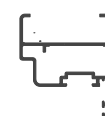

Tavola
B24

CX45.218		
Anta/persiana grande ellittica		
Peso	kg/ml.	1.364
Jx	28.56 cm ⁴	Wx 6.25 cm ³
Jy	23.45 cm ⁴	Wy 7.32 cm ³



Tavola
B38

CX45.209		
Anta ellittica piccola vetro infilare		
Peso	kg/ml.	1.118
Jx	10.64 cm ⁴	Wx 2.94 cm ³
Jy	16.18 cm ⁴	Wy 5.37 cm ³



Tavola
B22

CX45.219		
Anta per porte va e vieni		
Peso	kg/ml.	1.167
Jx	21,67 cm ⁴	Wx 4,66 cm ³
Jy	13,16 cm ⁴	Wy 5,19 cm ³







Tavola
B22

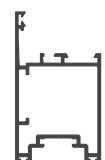

CX45.222			Tavola B25
Anta persiana ellittica raggiata			
Peso	kg/ml. 1.100		
Jx	10.34 cm ⁴ Wx 2.89 cm ³		
Jy	16.88 cm ⁴ Wy 5.14 cm ³		

CX45.403			Tavola B29
Fascia mm. 158			
Peso	kg/ml. 2.160		
Jx	25.57 cm ⁴ Wx 10.15 cm ³		
Jy	149.57 cm ⁴ Wy 18.93 cm ³		

CX45.301			Tavola B20
Riporto tondo			
Peso	kg/ml. 0.990		
Jx	7.01 cm ⁴ Wx 2.05 cm ³		
Jy	9.48 cm ⁴ Wy 3.84 cm ³		

CX45.404			Tavola B29
Zoccolo mm. 158			
Peso	kg/ml. 2.352		
Jx	27.80 cm ⁴ Wx 11.54 cm ³		
Jy	181.36 cm ⁴ Wy 21.20 cm ³		

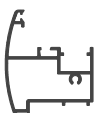
CX45.302			Tavola B27
Riporto tondo f/nastro			
Peso	kg/ml. 0.983		
Jx	7.00 cm ⁴ Wx 1.96 cm ³		
Jy	9.42 cm ⁴ Wy 3.83 cm ³		

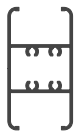
CX45.405			Tavola B26
Traverso v/infilare mm. 96			
Peso	kg/ml. 1.126		
Jx	14.71 cm ⁴ Wx 4.09 cm ³		
Jy	9.04 cm ⁴ Wy 4.67 cm ³		

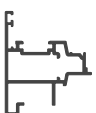
CX45.303			Tavola B30
Riporto/inversione bilico			
Peso	kg/ml. 0.913		
Jx	6.79 cm ⁴ Wx 2.09 cm ³		
Jy	8.76 cm ⁴ Wy 2.74 cm ³		

CX45.406			Tavola B26
Traverso v/infilare mm. 158			
Peso	kg/ml. 1.960		
Jx	21.88 cm ⁴ Wx 10.72 cm ³		
Jy	178.72 cm ⁴ Wy 22.62 cm ³		

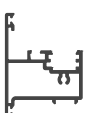
CX45.304			Tavola B20
Riporto dritto			
Peso	kg/ml. 0.934		
Jx	6.85 cm ⁴ Wx 1.96 mm ³		
Jy	9.36 cm ⁴ Wy 3.76 mm ³		

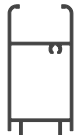
CX45.407			Tavola B26
Soprazoccolo v/infilare mm. 74			
Peso	kg/ml. 1.074		
Jx	22.96 cm ⁴ Wx 5.53 cm ³		
Jy	9.33 cm ⁴ Wy 4.81 cm ³		

CX45.306			Tavola B22
Riporto su telaio porte va e vieni			
Peso	kg/ml. 0.621		
Jx	2,00 cm ⁴ Wx 1,44 mm ³		
Jy	5,09 cm ⁴ Wy 2,07 mm ³		

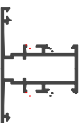
CX45.408			Tavola B28
Traverso piccolo mm. 72			
Peso	kg/ml. 0.954		
Jx	8.93 cm ⁴ Wx 2.31 cm ³		
Jy	9.20 cm ⁴ Wy 3.28 cm ³		

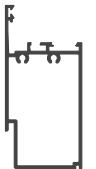
CX45.401			Tavola B28
Soprazoccolo			
Peso	kg/ml. 1.324		
Jx	38.83 cm ⁴ Wx 7.49 mm ³		
Jy	15.17 cm ⁴ Wy 6.27 mm ³		

CX45.409			Tavola B14
Soglia bassa			
Peso	kg/ml. 0.545		
Jx	0.45 cm ⁴ Wx 0.32 cm ³		
Jy	4.81 cm ⁴ Wy 2.03 cm ³		

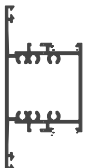
CX45.402			Tavola B28
Traverso mm.96			
Peso	kg/ml. 1.492		
Jx	26.39 cm ⁴ Wx 5.50 mm ³		
Jy	14.04 cm ⁴ Wy 5.28 mm ³		

CX45.410			Tavola B24
Fascia persiana 40 mm x 92 mm.			
Peso	kg/ml. 1.304		
Jx	37.30 cm ⁴ Wx 8.11 cm ³		
Jy	12.17 cm ⁴ Wy 5.71 cm ³		





PX45.411			Tavola B35
Fascia mm. 100			
Peso	kg/ml. 1.428		
Jx	0.00 cm ⁴ Wx 0.00 cm ³		
Jy	0.00 cm ⁴ Wy 0.00 cm ³		

CX70.524			Tavola B41
Fermavetro tondo mm. 26			
Peso	kg/ml. 0.314		
Jx	0.00 cm ⁴ Wx 0.00 cm ³		
Jy	0.00 cm ⁴ Wy 0.00 cm ³		

CX45.412			Tavola B38
Fascia entrata 25 mm.(140 x 40)			
Peso	kg/ml. 1.730		
Jx	0.00 cm ⁴ Wx 0.00 cm ³		
Jy	0.00 cm ⁴ Wy 0.00 cm ³		

CX70.525			Tavola B41
Fermavetro tondo mm. 30			
Peso	kg/ml. 0.350		
Jx	0.00 cm ⁴ Wx 0.00 cm ³		
Jy	0.00 cm ⁴ Wy 0.00 cm ³		

CX45.416			Tavola B28
Soglia H = 38 mm.			
Peso	kg/ml. 0.637		
Jx	0.00 cm ⁴ Wx 0.00 cm ³		
Jy	0.00 cm ⁴ Wy 0.00 cm ³		

CX70.526			Tavola B41
Fermavetro diritto mm. 14			
Peso	kg/ml. 0.279		
Jx	0.00 cm ⁴ Wx 0.00 cm ³		
Jy	0.00 cm ⁴ Wy 0.00 cm ³		

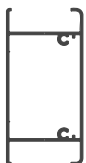
CX45.418			Tavola B24
Fascia persiana 45 mm x 92 mm.			
Peso	kg/ml. 1.253		
Jx	0.00 cm ⁴ Wx 0.00 cm ³		
Jy	0.00 cm ⁴ Wy 0.00 cm ³		

CX70.527			Tavola B41
Fermavetro diritto mm. 18			
Peso	kg/ml. 0.290		
Jx	0.00 cm ⁴ Wx 0.00 cm ³		
Jy	0.00 cm ⁴ Wy 0.00 cm ³		

CX45.419			Tavola B25
Fascia persiana 45 mm x 100 mm			
Peso	kg/ml. 1.311		
Jx	0.00 cm ⁴ Wx 0.00 cm ³		
Jy	0.00 cm ⁴ Wy 0.00 cm ³		

CX70.528			Tavola B41
Fermavetro diritto mm. 22			
Peso	kg/ml. 0.307		
Jx	0.00 cm ⁴ Wx 0.00 cm ³		
Jy	0.00 cm ⁴ Wy 0.00 cm ³		

CX70.521			Tavola B41
Fermavetro tondo mm. 14			
Peso	kg/ml. 0.266		
Jx	0.00 cm ⁴ Wx 0.00 cm ³		
Jy	0.00 cm ⁴ Wy 0.00 cm ³		

CX70.529			Tavola B41
Fermavetro diritto mm. 26			
Peso	kg/ml. 0.327		
Jx	0.00 cm ⁴ Wx 0.00 cm ³		
Jy	0.00 cm ⁴ Wy 0.00 cm ³		

CX70.522			Tavola B41
Fermavetro tondo mm. 18			
Peso	kg/ml. 0.277		
Jx	0.00 cm ⁴ Wx 0.00 cm ³		
Jy	0.00 cm ⁴ Wy 0.00 cm ³		

CX70.530			Tavola B41
Fermavetro diritto mm. 30			
Peso	kg/ml. 0.362		
Jx	0.00 cm ⁴ Wx 0.00 cm ³		
Jy	0.00 cm ⁴ Wy 0.00 cm ³		

CX70.523			Tavola B41
Fermavetro tondo mm. 22			
Peso	kg/ml. 0.294		
Jx	0.00 cm ⁴ Wx 0.00 cm ³		
Jy	0.00 cm ⁴ Wy 0.00 cm ³		

CX70.531			Tavola B41
Fermavetro tondo mm. 35			
Peso	kg/ml. 0.370		
Jx	0.00 cm ⁴ Wx 0.00 cm ³		
Jy	0.00 cm ⁴ Wy 0.00 cm ³		





CX70.532			Tavola B41
Fermavetro diritto mm. 35			
Peso	kg/ml. 0.383		
Jx 000.00 cm ⁴	Wx 000.00 cm ³		
Jy 000.00 cm ⁴	Wy 000.00 cm ³		

CX70.575			Tavola B42
Fermavetro clips tondo mm. 30			
Peso	kg/ml. 0.340		
Jx 000.00 cm ⁴	Wx 000.00 cm ³		
Jy 000.00 cm ⁴	Wy 000.00 cm ³		

CX70.533			Tavola B41
Fermavetro diritto mm. 5			
Peso	kg/ml. 0.252		
Jx 000.00 cm ⁴	Wx 000.00 cm ³		
Jy 000.00 cm ⁴	Wy 000.00 cm ³		

CX70.581			Tavola B42
Fermavetro clips tondo mm. 35			
Peso	kg/ml. 0.361		
Jx 000.00 cm ⁴	Wx 000.00 cm ³		
Jy 000.00 cm ⁴	Wy 000.00 cm ³		

CX45.534			Tavola B23
Riduttore vetro spazio mm. 12			
Peso	kg/ml. 0.321		
Jx 000.00 cm ⁴	Wx 000.00 cm ³		
Jy 000.00 cm ⁴	Wy 000.00 cm ³		

XX70.601			Tavola B21
Gocciolatoio			
Peso	kg/ml. 0.269		
Jx 000.00 cm ⁴	Wx 000.00 cm ³		
Jy 000.00 cm ⁴	Wy 000.00 cm ³		

CX70.537			Tavola B41
Fermavetro diritto mm. 40			
Peso	kg/ml. 0.403		
Jx 000.00 cm ⁴	Wx 000.00 cm ³		
Jy 000.00 cm ⁴	Wy 000.00 cm ³		

XX70.602			Tavola B29
Porta spazzolino			
Peso	kg/ml. 0.372		
Jx 000.00 cm ⁴	Wx 000.00 cm ³		
Jy 000.00 cm ⁴	Wy 000.00 cm ³		

CX70.571			Tavola B42
Fermavetro clips tondo mm. 14			
Peso	kg/ml. 0.216		
Jx 000.00 cm ⁴	Wx 000.00 cm ³		
Jy 000.00 cm ⁴	Wy 000.00 cm ³		

XX70.603			Tavola B29
Soglia piatta da mm. 5			
Peso	kg/ml. 0.275		
Jx 000.00 cm ⁴	Wx 000.00 cm ³		
Jy 000.00 cm ⁴	Wy 000.00 cm ³		

CX70.572			Tavola B42
Fermavetro clips tondo mm. 18			
Peso	kg/ml. 0.262		
Jx 000.00 cm ⁴	Wx 000.00 cm ³		
Jy 000.00 cm ⁴	Wy 000.00 cm ³		

CX45.604			Tavola B30
Inversione di battuta			
Peso	kg/ml. 0.761		
Jx 4.51 cm ⁴	Wx 1.46 cm ³		
Jy 6.22 cm ⁴	Wy 2.20 cm ³		

CX70.573			Tavola B42
Fermavetro clips tondo mm. 22			
Peso	kg/ml. 0.283		
Jx 000.00 cm ⁴	Wx 000.00 cm ³		
Jy 000.00 cm ⁴	Wy 000.00 cm ³		

CX70.605			Tavola B21
Astina			
Peso	kg/ml. 0.146		
Jx 0,00 cm ⁴	Wx 0,00 cm ³		
Jy 0,00 cm ⁴	Wy 0,00 cm ³		

CX70.574			Tavola B42
Fermavetro clips tondo mm. 26			
Peso	kg/ml. 0.313		
Jx 000.00 cm ⁴	Wx 000.00 cm ³		
Jy 000.00 cm ⁴	Wy 000.00 cm ³		

XX70.606			Tavola B14
Scivolo esterno soglia bassa			
Peso	kg/ml. 0.322		
Jx 0,00 cm ⁴	Wx 0,00 cm ³		
Jy 0,00 cm ⁴	Wy 0,00 cm ³		



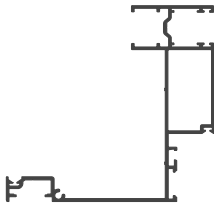

XX70.607			Tavola B14
Scivolo interno soglia bassa			
Peso	kg/ml. 0.224		
Jx	0,00 cm ⁴ Wx 0,00 cm ³		
Jy	0,00 cm ⁴ Wy 0,00 cm ³		

CX45.702			Tavola B31
Spalla laterale aperta			
Peso	kg/ml. 2.003		
Jx	127.01 cm ⁴ Wx 19.52 cm ³		
Jy	89.54 cm ⁴ Wy 10.96 cm ³		

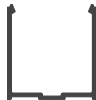
RX70.609			Tavola B17
Profilo a scatto pilastro riportato			
Peso	kg/ml. 0.393		
Jx	0.10 cm ⁴ Wx 0.11 cm ³		
Jy	3.99 cm ⁴ Wy 1.53 cm ³		

RX70.610			Tavola B17
Pilastrino riportato			
Peso	kg/ml. 0.994		
Jx	12.49 cm ⁴ Wx 3.56 cm ³		
Jy	17.78 cm ⁴ Wy 6.84 cm ³		

XX70.703			Tavola B31
Traverso superiore monoblocco			
Peso	kg/ml. 0.791		
Jx	000.00 cm ⁴ Wx 000.00 cm ³		
Jy	000.00 cm ⁴ Wy 000.00 cm ³		

XX70.611			Tavola B37
Squadretta a cianfrinare			
Peso	kg/ml. 3.426		
Jx	000.00 cm ⁴ Wx 000.00 cm ³		
Jy	000.00 cm ⁴ Wy 000.00 cm ³		

XX70.704			Tavola B32
Coprivite			
Peso	kg/ml. 0.135		
Jx	000.00 cm ⁴ Wx 000.00 cm ³		
Jy	000.00 cm ⁴ Wy 000.00 cm ³		

CX45.612			Tavola B14
Riporto esterno telaio ad H (25)			
Peso	kg/ml. 0.226		
Jx	0.83 cm ⁴ Wx 0.50 cm ³		
Jy	0.22 cm ⁴ Wy 0.16 cm ³		

XX70.705			Tavola B32
Profilo battuta cassonetto			
Peso	kg/ml. 0.155		
Jx	000.00 cm ⁴ Wx 000.00 cm ³		
Jy	000.00 cm ⁴ Wy 000.00 cm ³		

SX11.612			Tavola B14
Profilo battuta riportata 25 mm			
Peso	kg/ml. 0.254		
Jx	0.83 cm ⁴ Wx 0.50 cm ³		
Jy	0.22 cm ⁴ Wy 0.16 cm ³		

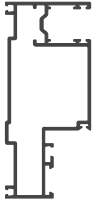
CX45.706			Tavola B32
Mezza spalla monoblocco			
Peso	kg/ml. 1.680		
Jx	90.10 cm ⁴ Wx 14.20 cm ³		
Jy	17.70 cm ⁴ Wy 6.41 cm ³		

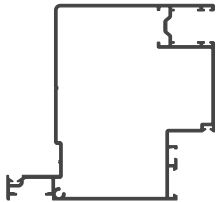
CX45.701			Tavola B31
Spalla laterale chiusa			
Peso	kg/ml. 2.286		
Jx	156.06 cm ⁴ Wx 26.16 cm ³		
Jy	123.94 cm ⁴ Wy 18.06 cm ³		

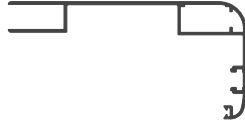

XX70.801			Tavola B34
Imbotte da mm.120			
Peso	kg/ml. 1.317		
Jx 76.93 cm ⁴	Wx 9.91 cm ³		
Jy 20.54 cm ⁴	Wy 4.10 cm ³		

XX70.809			Tavola B34
Imbotte da mm.140			
Peso	kg/ml. 1.580		
Jx 102.00 cm ⁴	Wx 10.00 cm ³		
Jy 22.30 cm ⁴	Wy 4.30 cm ³		

XX70.802			Tavola B34
Prolunga da 90 mm. per imbotte			
Peso	kg/ml. 0.882		
Jx 000.00 cm ⁴	Wx 000.00 cm ³		
Jy 000.00 cm ⁴	Wy 000.00 cm ³		

CX45.3362			Tavola B33
Profilo centrale cassonetto			
Peso	kg/ml. 1.150		

XX70.803			Tavola B34
Prolunga da 50 mm. per imbotte			
Peso	kg/ml. 0.570		
Jx 000.00 cm ⁴	Wx 000.00 cm ³		
Jy 000.00 cm ⁴	Wy 000.00 cm ³		

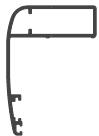
CX45.804			Tavola B36
Imbotte interna porte da mm.52			
Peso	kg/ml. 0.884		
Jx 17.16 cm ⁴	Wx 3.47 cm ³		
Jy 10.51 cm ⁴	Wy 3.03 cm ³		

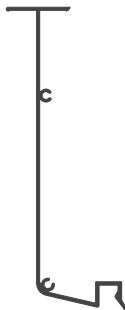
CX45.3363			Tavola B33
Profilo sup./ inf. cassonetto			
Peso	kg/ml. 1.379		

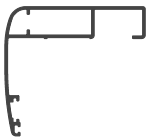
CX45.805			Tavola B36
Imbotte interna porte da mm.82			
Peso	kg/ml. 1.098		
Jx 20.41 cm ⁴	Wx 3.75 cm ³		
Jy 30.59 cm ⁴	Wy 5.67 cm ³		

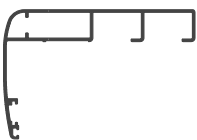
CX45.806			Tavola B36
Imbotte interna porte da mm.112			
Peso	kg/ml. 1.311		
Jx 22.42 cm ⁴	Wx 3.93 cm ³		
Jy 67.96 cm ⁴	Wy 9.46 cm ³		

RX450.3570			Tavola B39
Angolo variabile			
Peso	kg/ml. 0.922		
Jx 2,96 cm ⁴	Wx 1,25 cm ³		
Jy 11,43 cm ⁴	Wy 3,58 cm ³		

CX45.807			Tavola B36
Prolunga imbotte porte da mm.50			
Peso	kg/ml. 0.415		
Jx 0.52 cm ⁴	Wx 0.41 cm ³		
Jy 14.21 cm ⁴	Wy 1.51 cm ³		

RX450.9303			Tavola B39
Controltelaio di compensazione			
Peso	kg/ml. 0.462		
Jx 1.00 cm ⁴	Wx 0.49 cm ³		
Jy 6.05 cm ⁴	Wy 2.50 cm ³		

XX70.808			Tavola B34
Profilo jolly per imbotte			
Peso	kg/ml. 0.750		
Jx 000.00 cm ⁴	Wx 000.00 cm ³		
Jy 000.00 cm ⁴	Wy 000.00 cm ³		

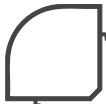
RX450.9525			Tavola B39
Profilo angolo 90 °			
Peso	kg/ml. 1.037		
Jx 14.04 cm ⁴	Wx 5.10 cm ³		
Jy 14.04 cm ⁴	Wy 5.10 cm ³		



Linea **elite**

CX45.250	
Anta/persiana grande ellittica	
Peso	kg/ml. 1.374
Jx	28.56 cm ⁴
Wx	6.25 cm ³
Jy	23.45 cm ⁴
Wy	7.32 cm ³



Tavola
B46

CX45.456	
Fascia ornamentale da mm.136	
Peso	kg/ml. 1.870
Jx	33.40 cm ⁴
Wx	12.52 cm ³
Jy	136.47 cm ⁴
Wy	20.07 cm ³



Tavola
B48

CX45.253	
Anta/persiana picc.ornamentale	
Peso	kg/ml. 1.090
Jx	12.14 cm ⁴
Wx	3.14 cm ³
Jy	14.90 cm ⁴
Wy	5.01 cm ³



Tavola
B45

CX45.457	
Soprazoccolo ornam.da mm.70	
Peso	kg/ml. 1.302
Jx	23.91 cm ⁴
Wx	6.47 cm ³
Jy	18.96 cm ⁴
Wy	7.14 cm ³

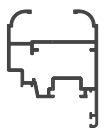

Tavola
B48

CX45.256	
Anta/persiana gran.ornamentale	
Peso	kg/ml. 1.262
Jx	26.08 cm ⁴
Wx	5.59 cm ³
Jy	18.88 cm ⁴
Wy	6.49 cm ³

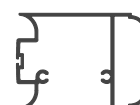

Tavola
B45

CX45.458	
Soprazoccolo ornam.da mm.127	
Peso	kg/ml. 1.820
Jx	34.01 cm ⁴
Wx	12.65 cm ³
Jy	131.25 cm ⁴
Wy	19.02 cm ³

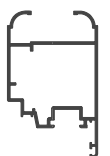

Tavola
B47

CX45.259	
Anta/persiana piccola ellittica	
Peso	kg/ml. 1.179
Jx	13.04 cm ⁴
Wx	3.43 cm ³
Jy	17.62 cm ⁴
Wy	5.50 cm ³



Tavola
B46

CX45.652	
Porta spazzolino per fascia orn.	
Peso	kg/ml. 0.562
Jx	0.11 cm ⁴
Wx	0.11 cm ³
Jy	3.76 cm ⁴
Wy	1.44 cm ³



Tavola
B47

CX45.351	
Riporto centrale Elite	
Peso	kg/ml. 0.953
Jx	10.09 cm ⁴
Wx	3.94 cm ³
Jy	7.18 cm ⁴
Wy	2.06 cm ³



Tavola
B47

CX45.450	
Fascia ornamentale da mm.100	
Peso	kg/ml. 1.558
Jx	25.50 cm ⁴
Wx	9.52 cm ³
Jy	56.89 cm ⁴
Wy	11.38 cm ³



Tavola
B48

CX45.455	
Fascia ornamentale da mm. 60	
Peso	kg/ml. 1.218
Jx	16.72 cm ⁴
Wx	6.21 cm ³
Jy	11.97 cm ⁴
Wy	3.99 cm ³

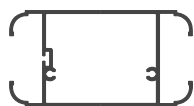

Tavola
B48

Nota tecnica:

I profili della "Linea Elite" devono essere utilizzati, sia nella versione a giunto aperto che doppia battuta/persiana, con il profilo di riporto unico art. CX45.351 e relativo tappo per il riporto centrale. Possono altresì essere utilizzati nella versione doppia battuta/persiana anche con i profili di riporto art. CX45.301 (tondo) e art. CX45.304 (diritto)

Technical Note:

The profiles of the "Linea Elite" must be used, both in the open and double joint version rebate/shutter, with a single profile art. CX45.351 and relative cap for the central filling.

They can also be used in the version double rebate/shutter also with carry-over profiles art. CX45.301 (round) and art. CX45.304 (straight)





Linea Persiana
LUXOR 36.2 mm.

<p>CX45.216</p> <p>Anta persiana entrata 36.2 mm.</p> <p>Peso kg/ml. 1.057</p> <p>Jx 00.00 cm⁴ Wx 0.00 cm³</p> <p>Jy 00.00 cm⁴ Wy 0.00 cm³</p>		<p>Tavola B49</p>	<p>CX45.625</p> <p>Mezza -lamella ridotta Perla 70</p> <p>Peso kg/ml. 0.313</p> <p>Jx 00.00 cm⁴ Wx 0.00 cm³</p> <p>Jy 00.00 cm⁴ Wy 0.00 cm³</p>		<p>Tavola B50</p>
<p>CX45.413</p> <p>Fascia da mm.100 entr. 36.2 mm.</p> <p>Peso kg/ml. 1.377</p> <p>Jx 00.00 cm⁴ Wx 0.00 cm³</p> <p>Jy 00.00 cm⁴ Wy 0.00 cm³</p>		<p>Tavola B49</p>	<p>CX45.221</p> <p>Anta pers.ellittica entr. 36.2 mm.</p> <p>Peso kg/ml. 1.137</p> <p>Jx 00.00 cm⁴ Wx 0.00 cm³</p> <p>Jy 00.00 cm⁴ Wy 0.00 cm³</p>		<p>Tavola B49</p>
<p>CX45.620</p> <p>Ovalina 50 mm. x 10 mm.</p> <p>Peso kg/ml. 0.364</p> <p>Jx 00.00 cm⁴ Wx 0.00 cm³</p> <p>Jy 00.00 cm⁴ Wy 0.00 cm³</p>		<p>Tavola B50</p>	<p>CX45.236</p> <p>Anta pers.grande entr. 36.2 mm.</p> <p>Peso kg/ml. 1.294</p> <p>Jx 00.00 cm⁴ Wx 0.00 cm³</p> <p>Jy 00.00 cm⁴ Wy 0.00 cm³</p>		<p>Tavola B49</p>
<p>CX45.621</p> <p>Base per mezza-lamella</p> <p>Peso kg/ml. 0.308</p> <p>Jx 00.00 cm⁴ Wx 0.00 cm³</p> <p>Jy 00.00 cm⁴ Wy 0.00 cm³</p>		<p>Tavola B50</p>			
<p>CX45.622</p> <p>Lamella Perla 70</p> <p>Peso kg/ml. 0.530</p> <p>Jx 00.00 cm⁴ Wx 0.00 cm³</p> <p>Jy 00.00 cm⁴ Wy 0.00 cm³</p>		<p>Tavola B50</p>			
<p>CX45.623</p> <p>Mezza -lamella Perla 70</p> <p>Peso kg/ml. 0.448</p> <p>Jx 00.00 cm⁴ Wx 0.00 cm³</p> <p>Jy 00.00 cm⁴ Wy 0.00 cm³</p>		<p>Tavola B50</p>			
<p>CX45.624</p> <p>Profilo chiudi-cava da 36 mm.</p> <p>Peso kg/ml. 0.270</p> <p>Jx 00.00 cm⁴ Wx 0.00 cm³</p> <p>Jy 00.00 cm⁴ Wy 0.00 cm³</p>		<p>Tavola B50</p>			





Linea Kosmica

CX45.229			Tavola B51
Anta Kosmica			
Peso	kg/ml. 1.365		
Jx	22.54 cm ⁴ Wx 7.27 cm ³		
Jy	17.67 cm ⁴ Wy 4.26 cm ³		

CX45.4641			Tavola B51
Lamella reversibile			
Peso	kg/ml. 0.566		
Jx	00.00 cm ⁴ Wx 0.00 cm ³		
Jy	00.00 cm ⁴ Wy 0.00 cm ³		

CX45.3352			Tavola B51
Fascia mm.100x40 entr.22.5 mm.			
Peso	kg/ml. 1.698		
Jx	00.00 cm ⁴ Wx 0.00 cm ³		
Jy	00.00 cm ⁴ Wy 0.00 cm ³		

CX45.4645			Tavola B51
Compensatore			
Peso	kg/ml. 0.524		
Jx	00.00 cm ⁴ Wx 0.00 cm ³		
Jy	00.00 cm ⁴ Wy 0.00 cm ³		

CX45.4103			Tavola B51
Fascia sagom. s/compensatore			
Peso	kg/ml. 1.107		
Jx	00.00 cm ⁴ Wx 0.00 cm ³		
Jy	00.00 cm ⁴ Wy 0.00 cm ³		

CX45.5986			Tavola B51
Lamella			
Peso	kg/ml. 0.532		
Jx	00.00 cm ⁴ Wx 0.00 cm ³		
Jy	00.00 cm ⁴ Wy 0.00 cm ³		

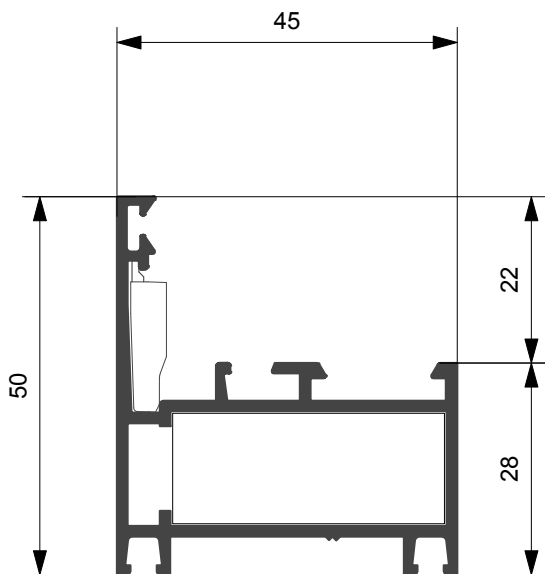

CX45.101

Kg/ml 0,777
--- mm. 78,0

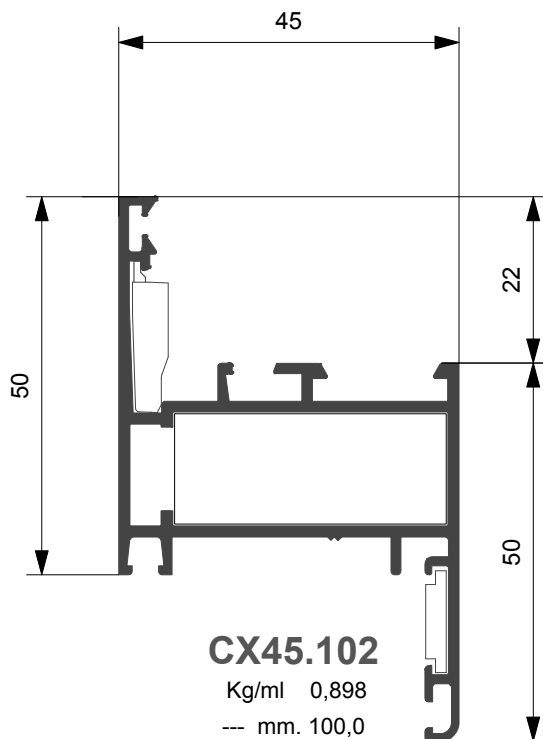

CX45.102

Kg/ml 0,898
--- mm. 100,0

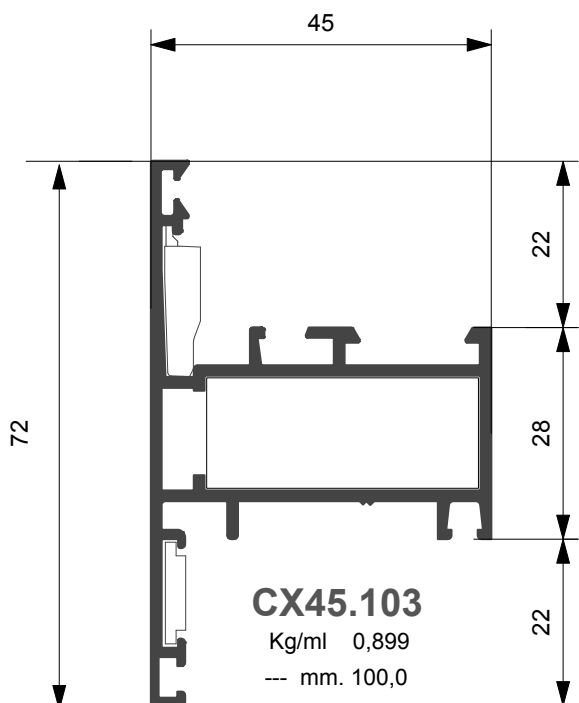

CX45.103

Kg/ml 0,899
--- mm. 100,0

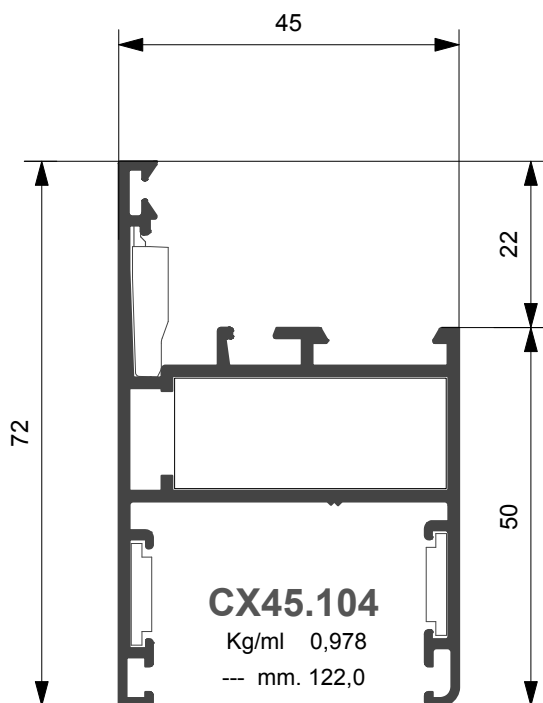

CX45.104

Kg/ml 0,978
--- mm. 122,0

Profilato	Squadretta esterna		Squadretta interna			Squadretta allineamento	
	Cianfrinare	Spinare	Bottone	Cianfrinare	Spinare	Esterna	Interna
CX45.101			ACX.21.SQ			ARX.15.SQ	
CX45.102			ACX.21.SQ			ARX.15.SQ	ARX.10.SQ
CX45.103			ACX.21.SQ			ARX.15.SQ	ARX.10.SQ
CX45.104			ACX.21.SQ			ARX.15.SQ	ARX.10.SQ

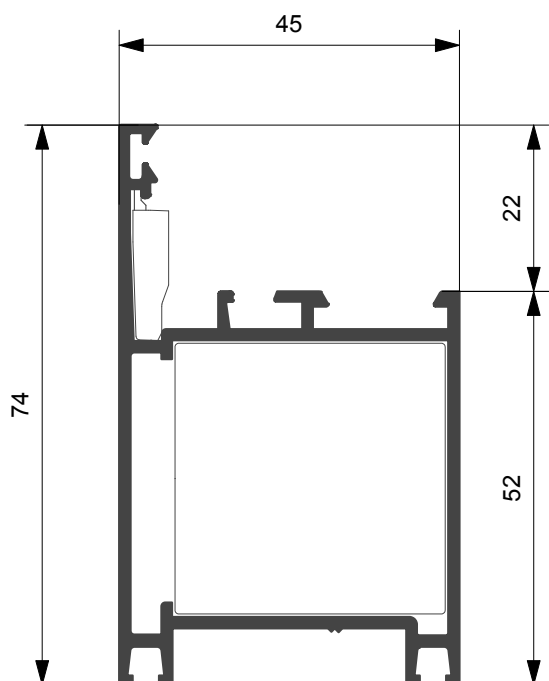

CX45.105

Kg/ml 1.026
--- mm. 126,0

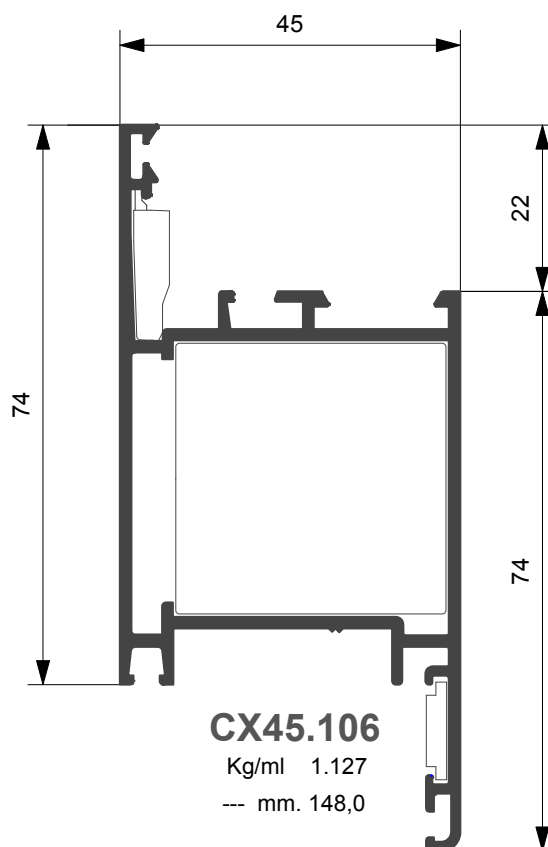

CX45.106

Kg/ml 1.127
--- mm. 148,0

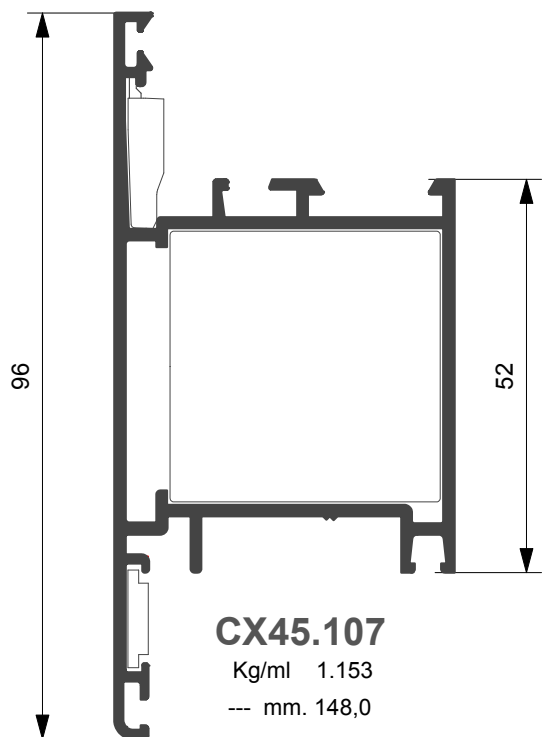

CX45.107

Kg/ml 1.153
--- mm. 148,0

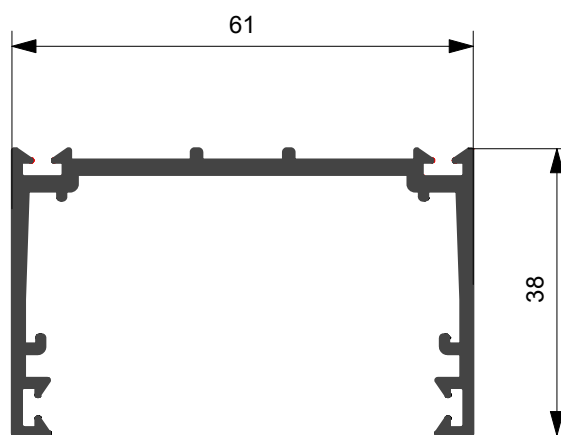

CX45.113

Kg/ml 0.801
--- mm. 86,0

Profilato	Squadretta esterna		Squadretta interna			Squadretta allineamento	
	Cianfrinare	Spinare	Bottone	Cianfrinare	Spinare	Esterna	Interna
CX45.105			ACX.22.SQ			ARX.15.SQ	
CX45.106			ACX.22.SQ			ARX.15.SQ	ARX.10.SQ
CX45.107			ACX.22.SQ			ARX.15.SQ	ARX.10.SQ

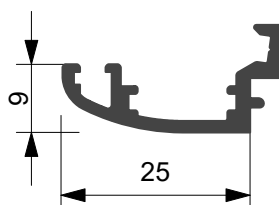
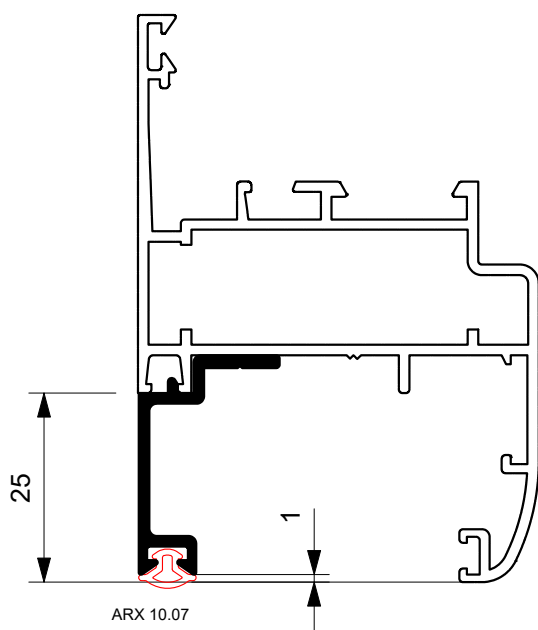
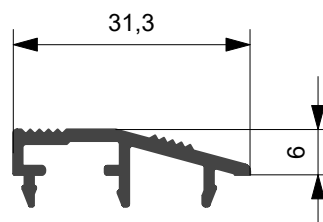
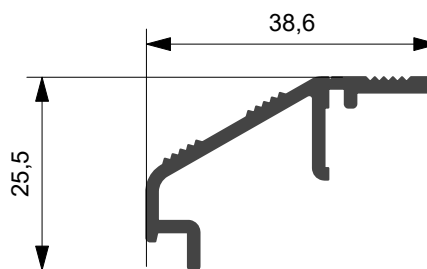
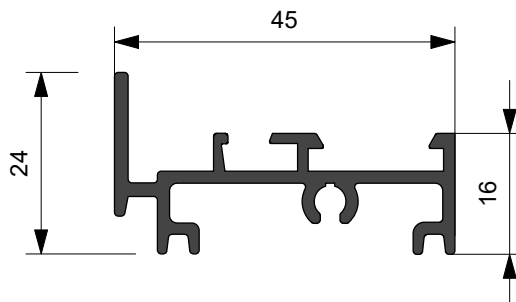
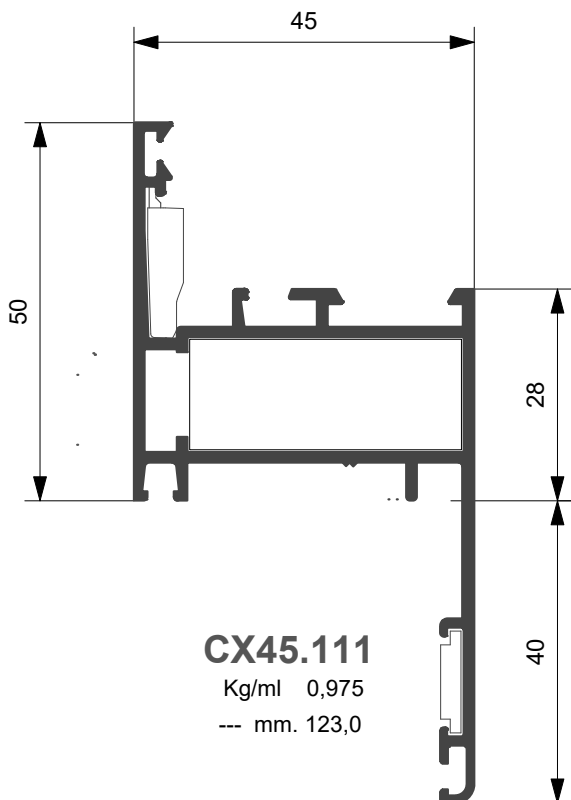

Profilato	Squadretta esterna		Squadretta interna			Squadretta allineamento	
	Cianfrinare	Spinare	Bottone	Cianfrinare	Spinare	Esterna	Interna
CX45.111			ACX.21.SQ			ARX.15.SQ	ARX.10.SQ

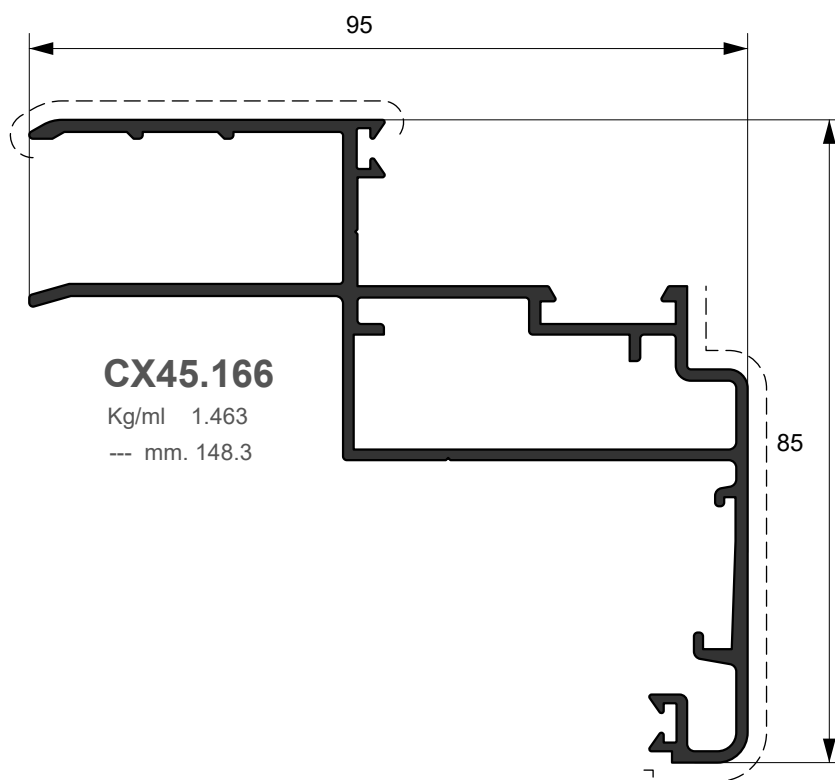
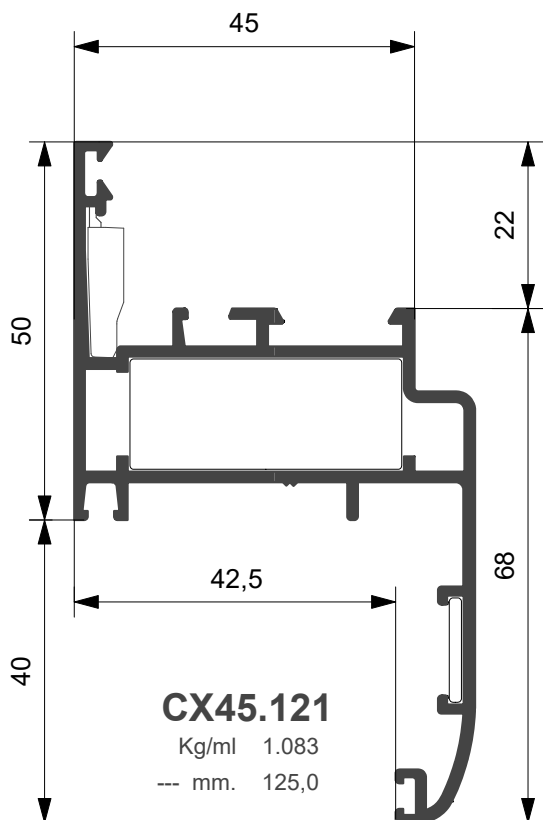
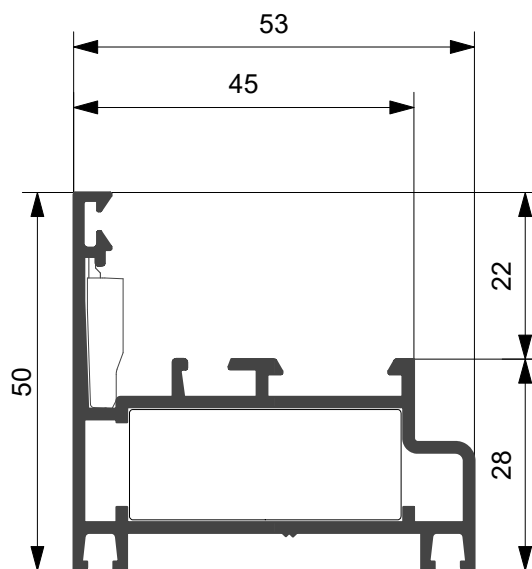
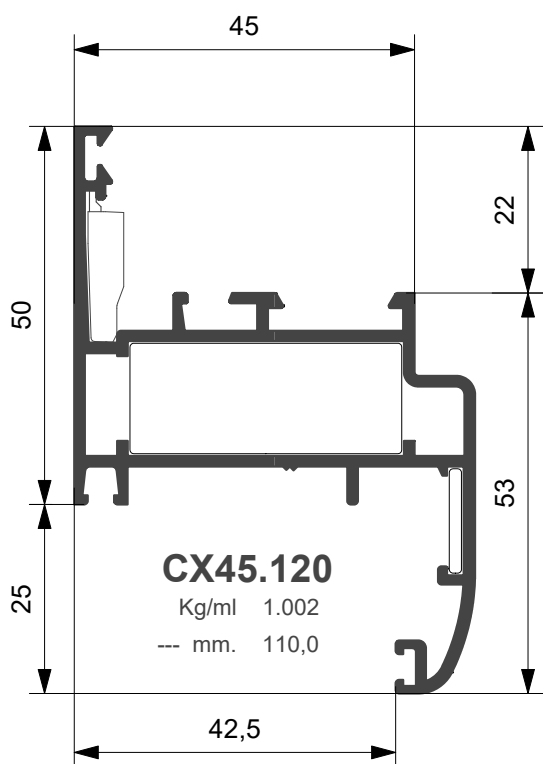

Profilato	Squadretta esterna		Squadretta interna			Squadretta allineamento	
	Cianfrinare	Spinare	Bottone	Cianfrinare	Spinare	Esterna	Interna
CX45.120			ACX.21.SQ			ARX.15.SQ	ARX.10.SQ
CX45.121			ACX.21.SQ			ARX.15.SQ	ARX.10.SQ
CX45.135			ACX.21.SQ			ARX.15.SQ	

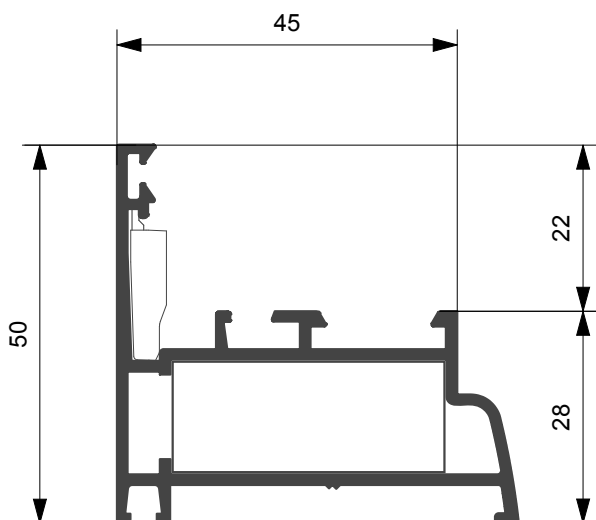

CX45.114

Kg/ml 0.805
--- mm. 78,0

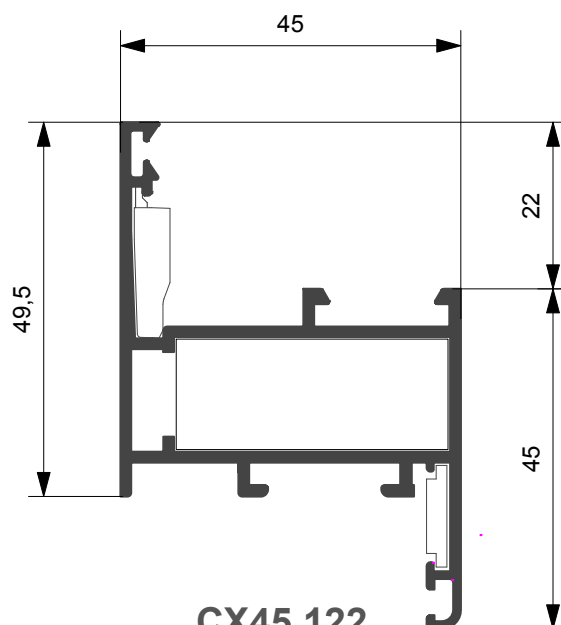

CX45.122

Kg/ml 0.845
--- mm. 100,0

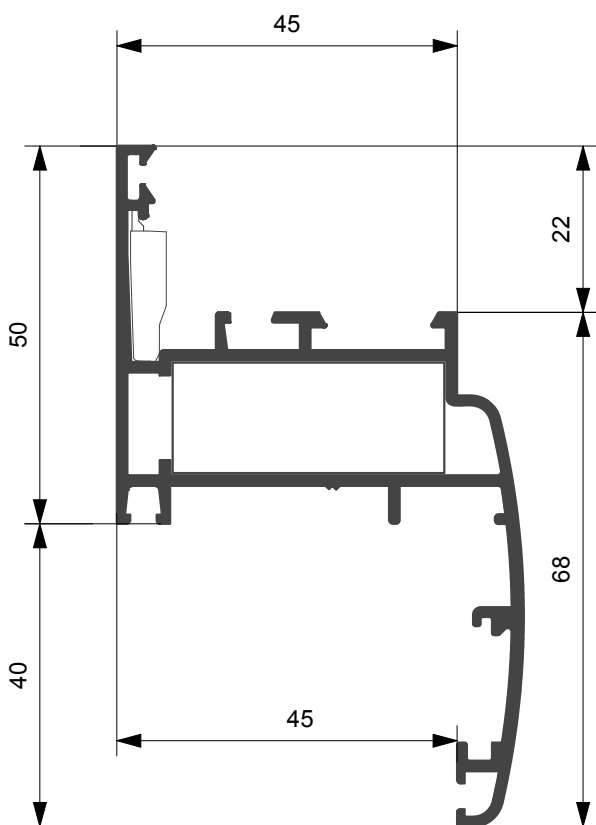

CX45.115

Kg/ml 1.080
--- mm. 120,0

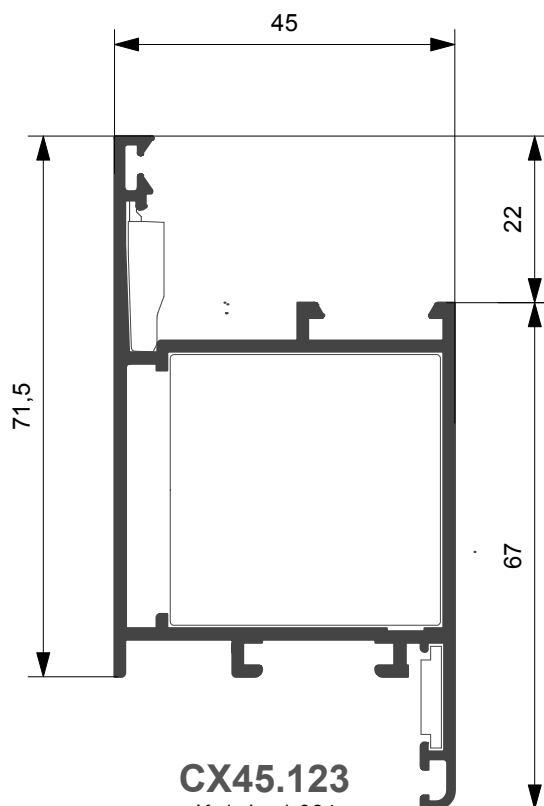

CX45.123

Kg/ml 1.064
--- mm. 148,0

Profilato	Squadretta esterna		Squadretta interna			Squadretta allineamento	
	Cianfrinare	Spinare	Bottone	Cianfrinare	Spinare	Esterna	Interna
CX45.114			ACX.21.SQ			ARX.15.SQ	ARX.10.SQ
CX45.115			ACX.21.SQ			ARX.15.SQ	ARX.10.SQ
CX45.122			ACX.21.SQ			ARX.15.SQ	ARX.10.SQ
CX45.123			ACX.21.SQ			ARX.15.SQ	

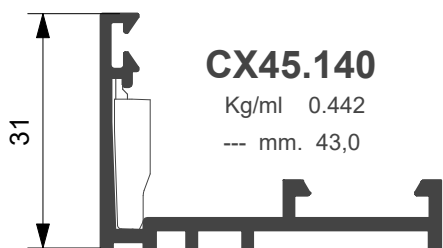

CX45.140

Kg/ml 0.442
--- mm. 43,0

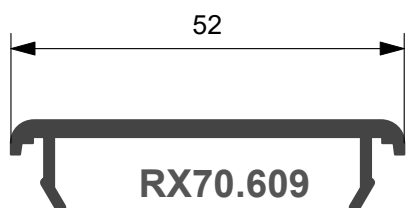

RX70.609

Kg/ml 0,391
--- mm. 55,0

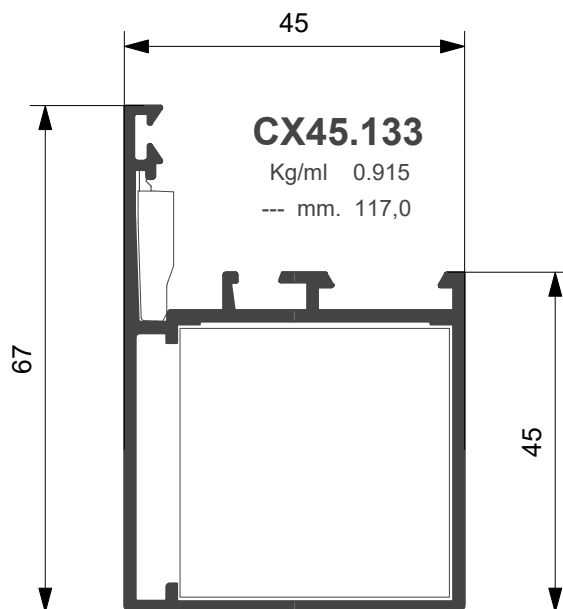

CX45.133

Kg/ml 0.915
--- mm. 117,0

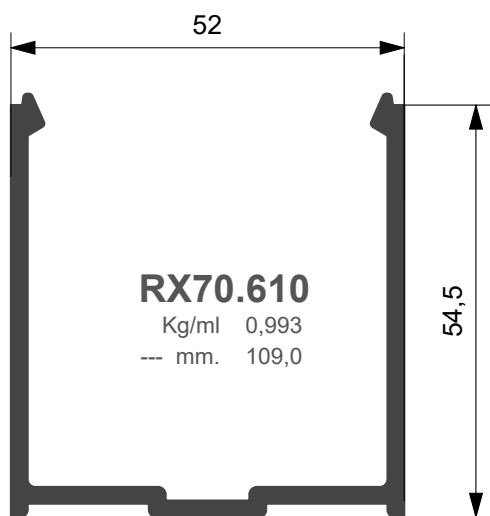

RX70.610

Kg/ml 0,993
--- mm. 109,0

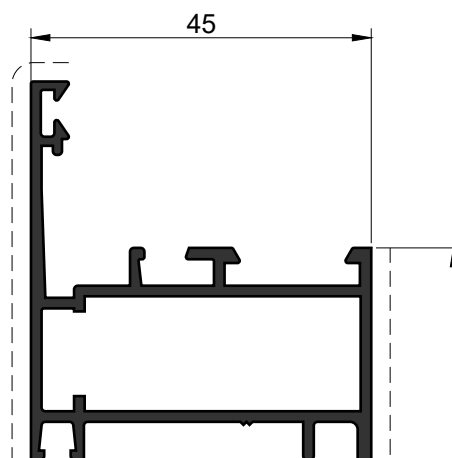

CX45.186

Kg/ml 1,114
--- mm. 159,2

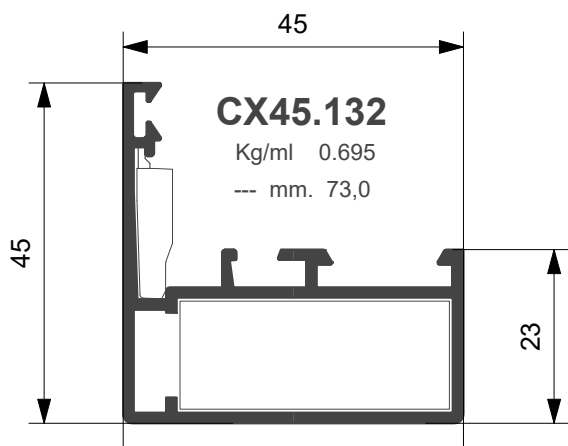

CX45.132

Kg/ml 0.695
--- mm. 73,0

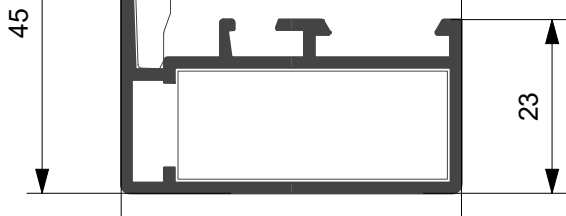

Profilato	Squadretta esterna		Squadretta interna			Squadretta allineamento	
	Cianfrinare	Spinare	Bottone	Cianfrinare	Spinare	Esterna	Interna
CX45.132			ACX.21.SQ			ARX.15.SQ	
CX45.133			ACX.22.SQ			ARX.15.SQ	
CX45.140						ARX.15.SQ	

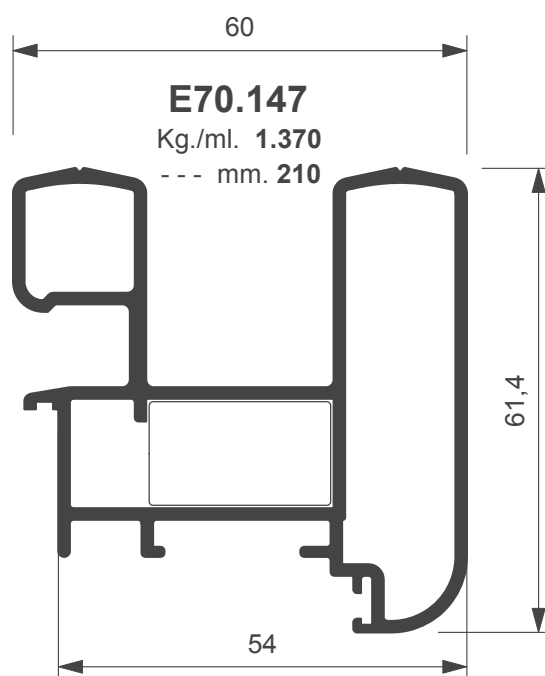
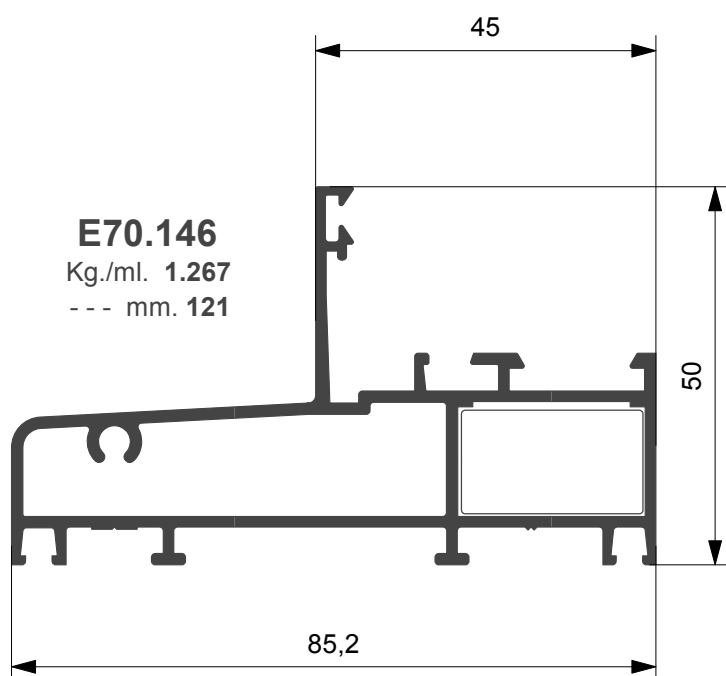
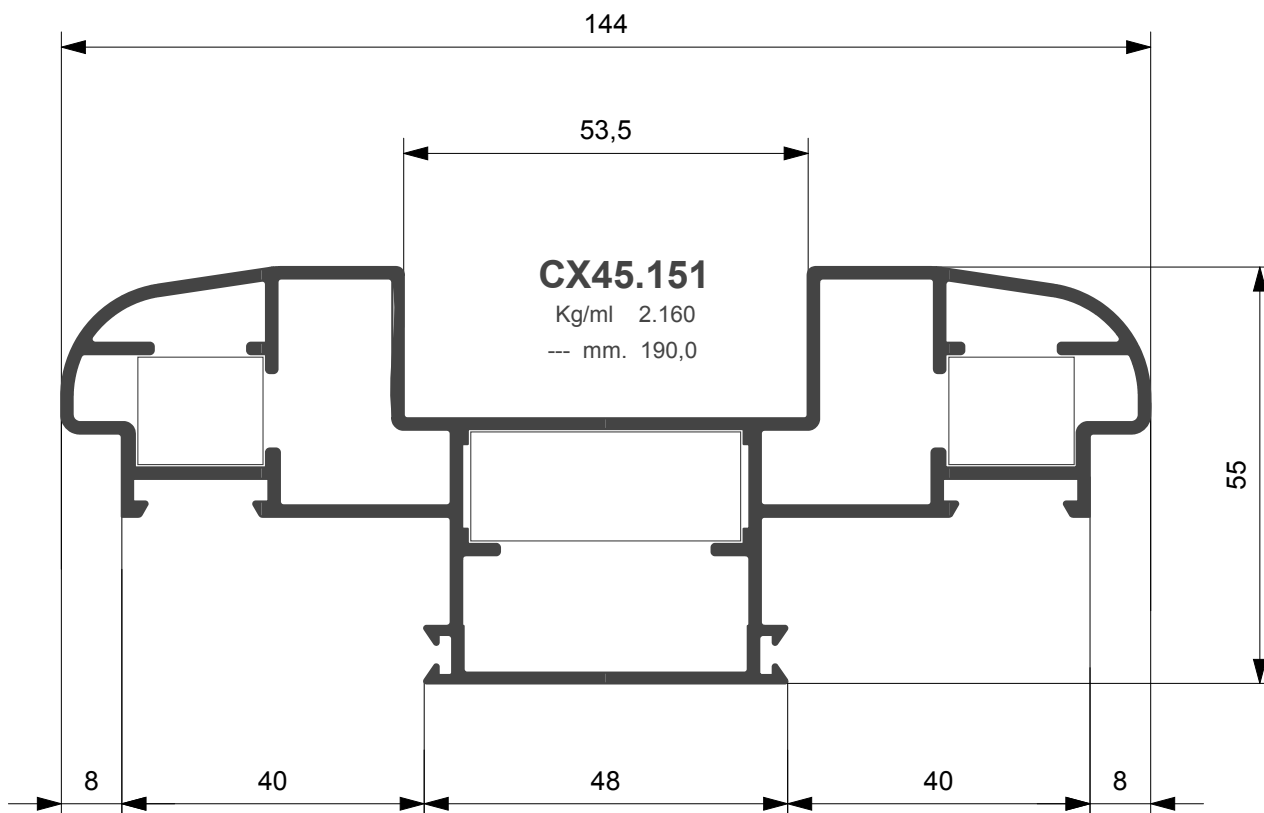

Profilato	Squadretta esterna		Squadretta interna			Squadretta allineamento	
	Cianfrinare	Spinare	Bottone	Cianfrinare	Avvitare	Esterna	Interna
CX45.151			ACX.21.SQ		AWX.19.SQ + VILM5X14-D8	ARX.15.SQ	
E70.146			EKA 60			ARX.15.SQ	
E70.147			EKA 60				

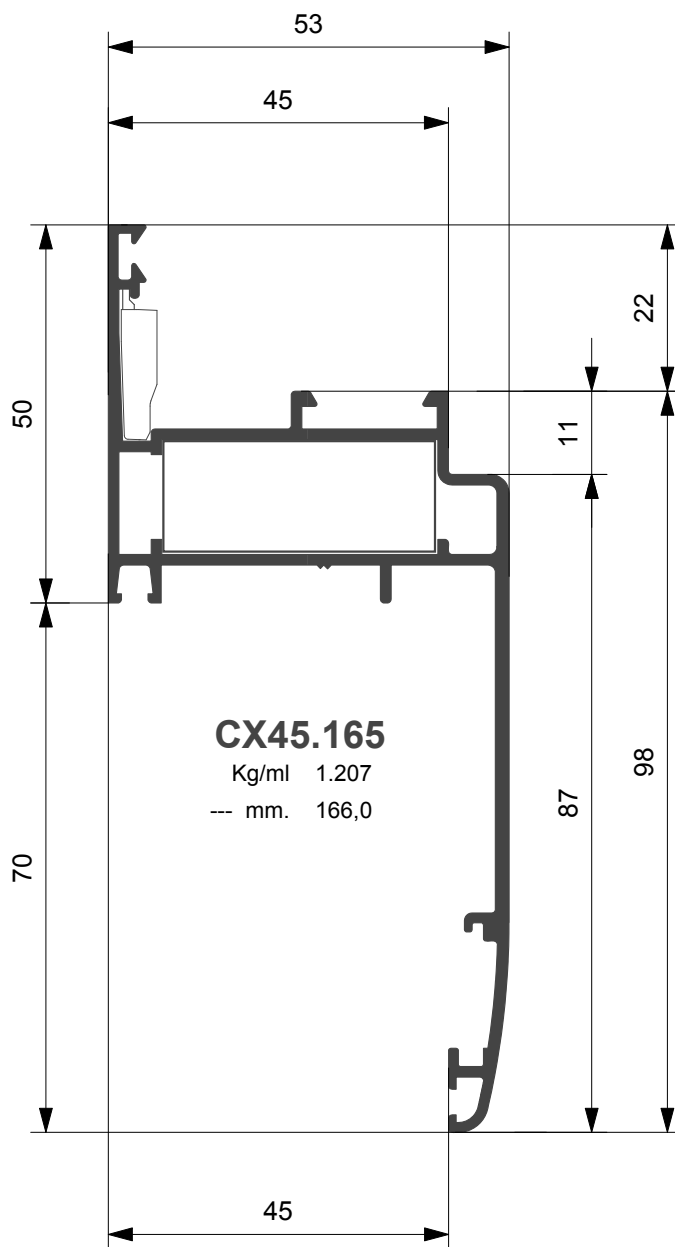
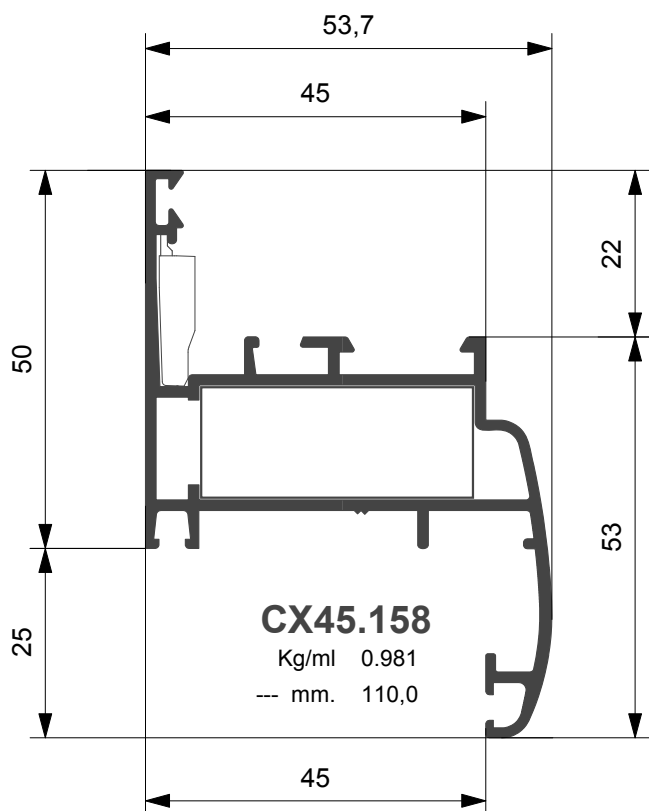
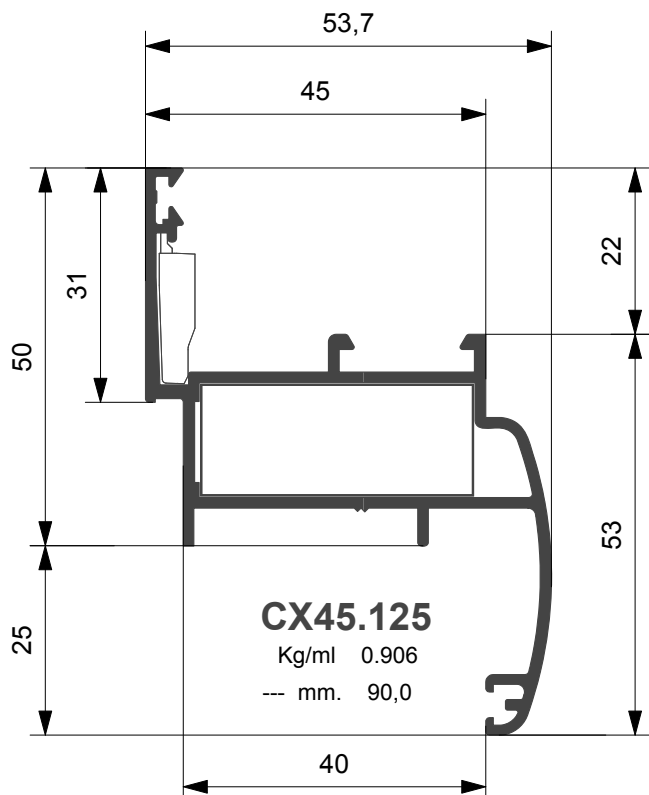

Profilato	Squadretta esterna		Squadretta interna			Squadretta allineamento	
	Cianfrinare	Spinare	Bottone	Cianfrinare	Spinare	Esterna	Interna
CX45.125			ACX.21.SQ			ARX.15.SQ	
CX45.158			ACX.21.SQ			ARX.15.SQ	
CX45.165			ACX.21.SQ			ARX.15.SQ	

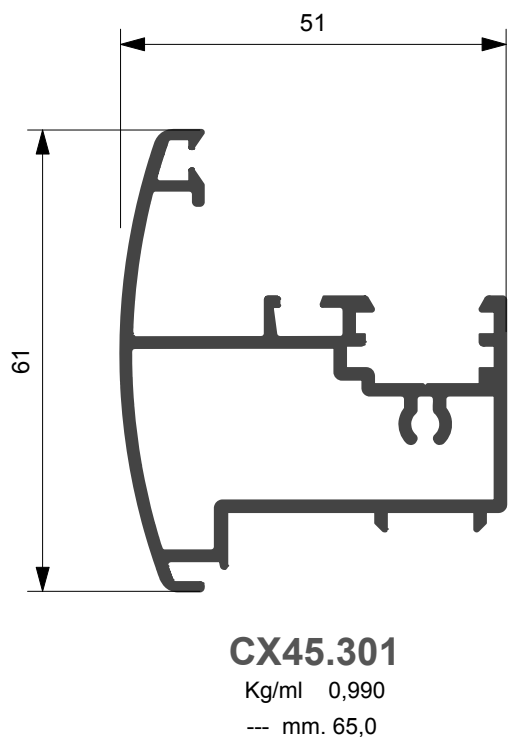
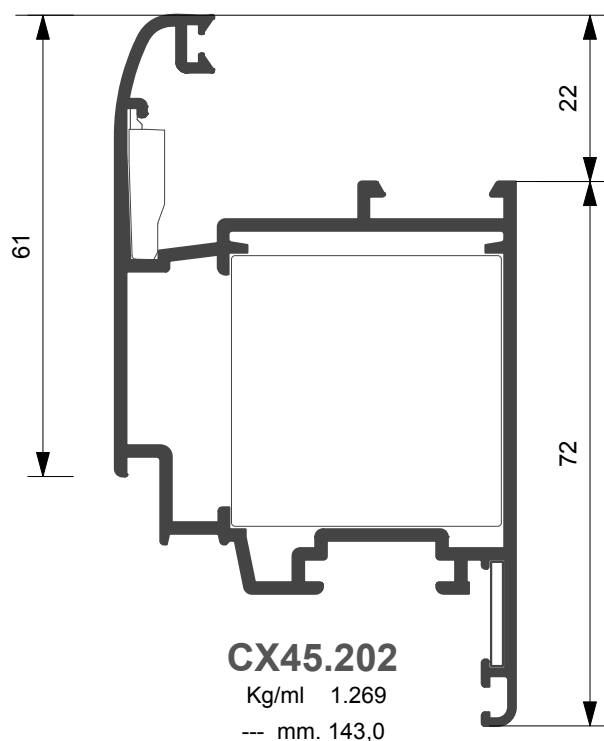
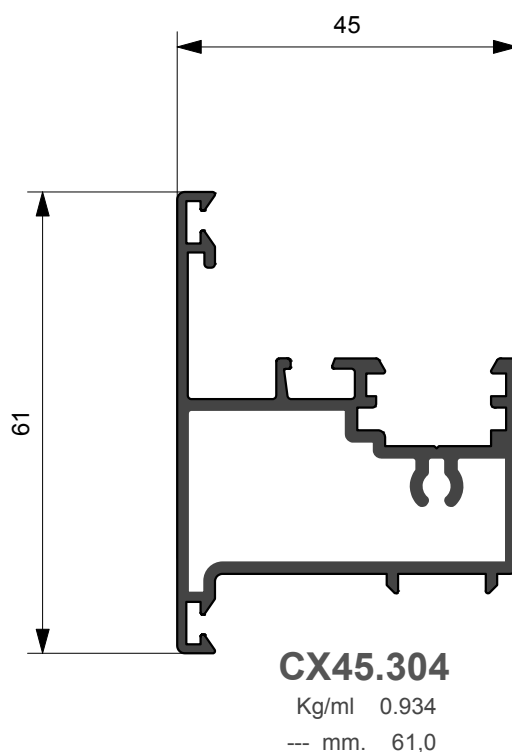
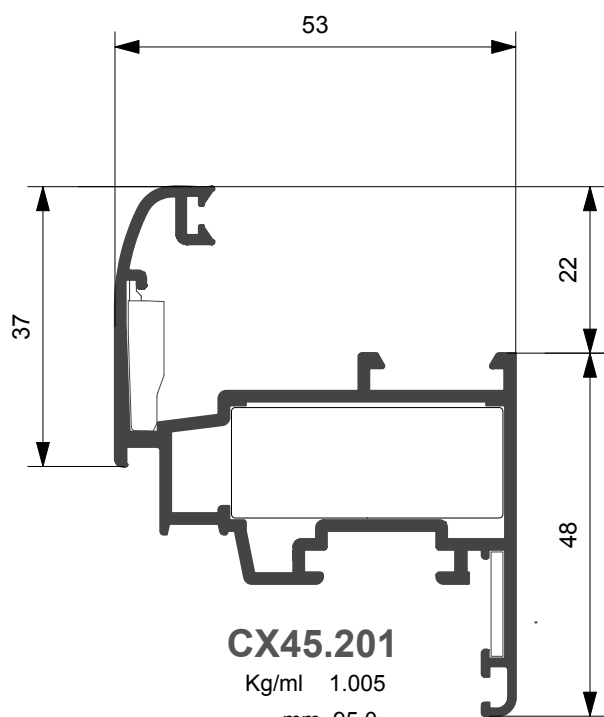

Profilato	Squadretta esterna		Squadretta interna			Squadretta allineamento	
	Cianfrinare	Spinare	Bottone	Cianfrinare	Spinare	Esterna	Interna
CX45.201			ACX.21.SQ			ARX.15.SQ	ARX.10.SQ
CX45.202			ACX.22.SQ			ARX.15.SQ	ARX.10.SQ

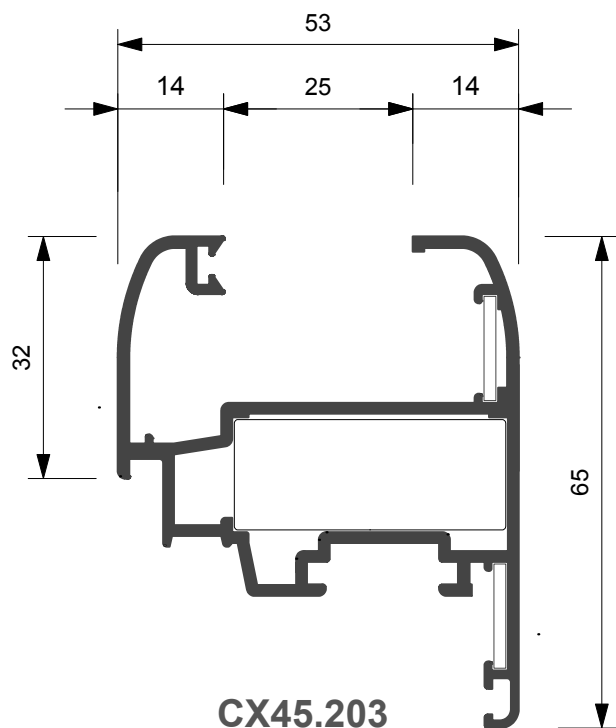

CX45.203
Kg/ml 1.080
--- mm. 112,0

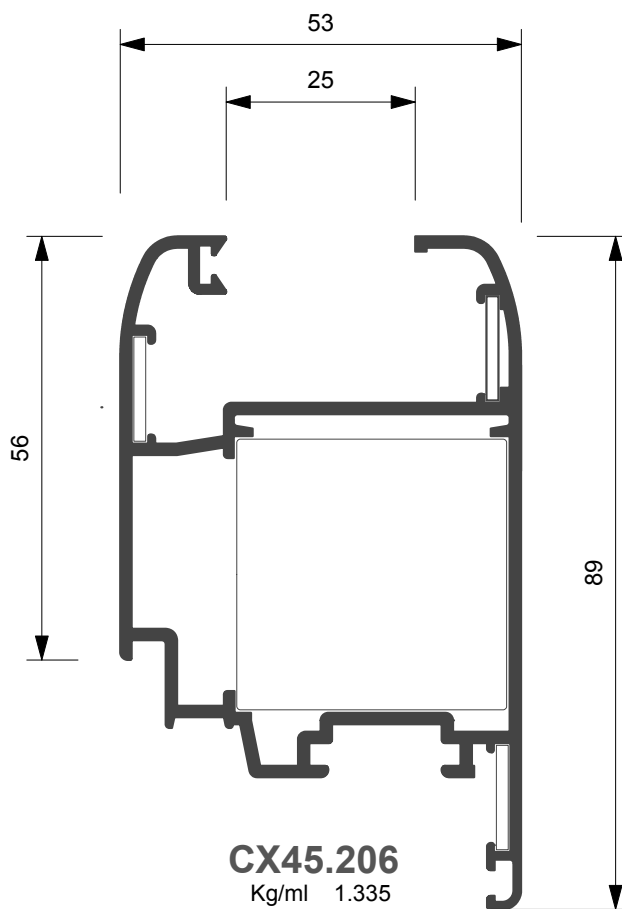

CX45.206
Kg/ml 1.335
--- mm. 139,0



XX70.601
Kg/ml 0.269
--- mm. 000,0



CX70.605
Kg/ml 0,146
--- mm. 14,0

Profilato	Squadretta esterna		Squadretta interna			Squadretta allineamento	
	Cianfrinare	Spinare	Bottone	Cianfrinare	Spinare	Esterna	Interna
CX45.203			ACX.21.SQ				ARX.10.SQ
CX45.206			ACX.22.SQ			ARX.10.SQ	ARX.10.SQ

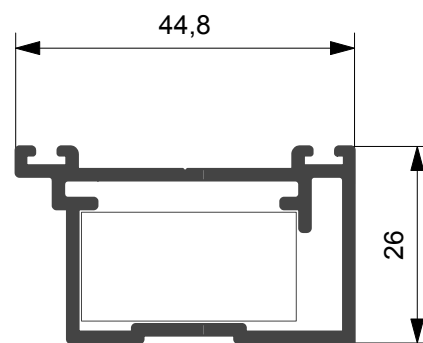
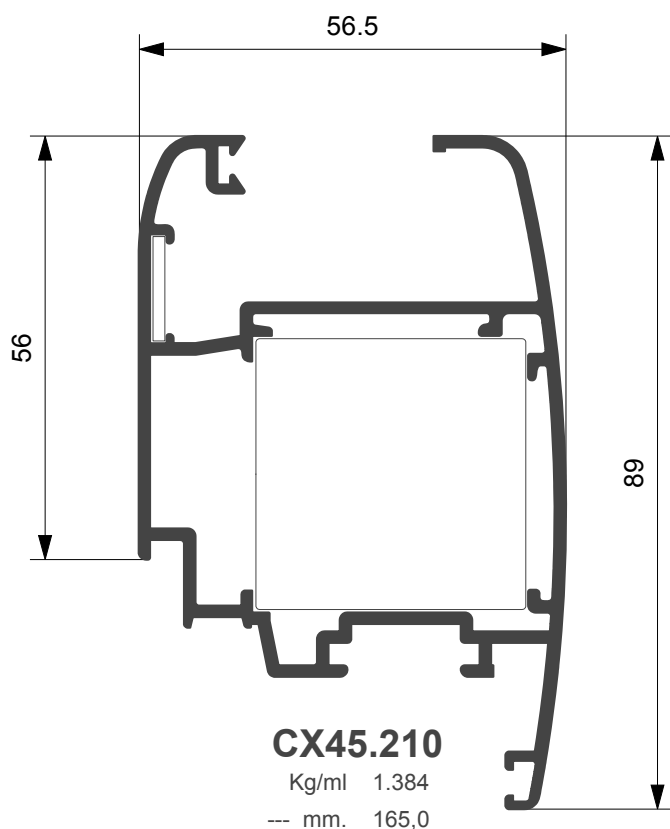
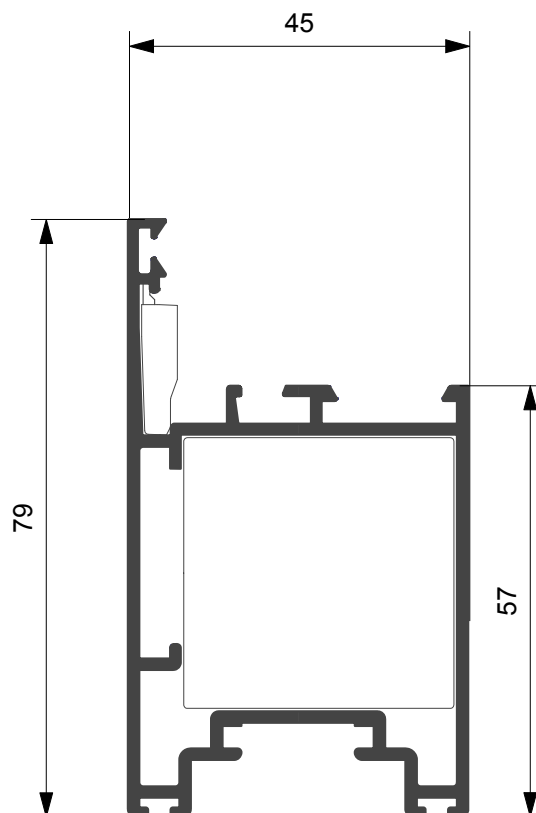
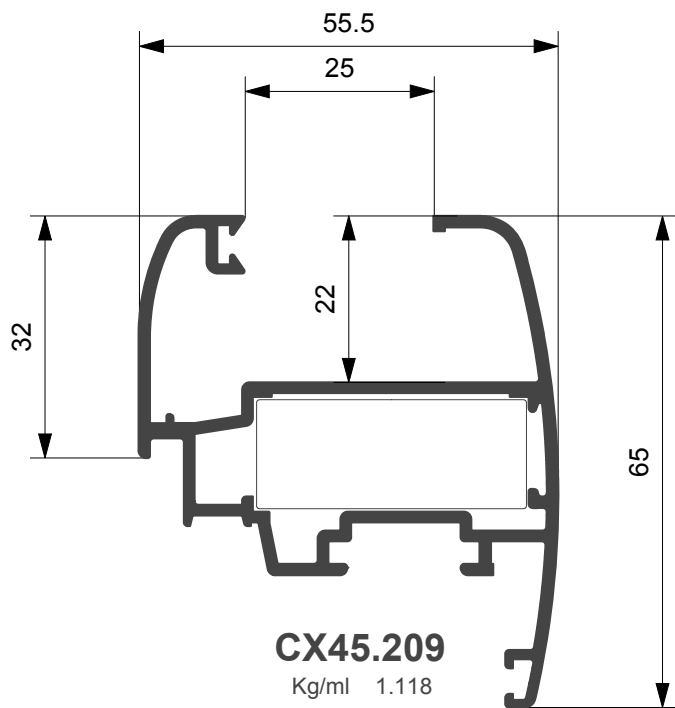

Profilato	Squadretta esterna		Squadretta interna			Squadretta allineamento	
	Cianfrinare	Spinare	Bottone	Cianfrinare	Spinare	Esterna	Interna
CX45.209			ACX.21.SQ				
CX45.210			ACX.22.SQ			ARX.10.SQ	
CX45.219			ACX.22.SQ			ARX.15.SQ	
CX45.306			ACX.13.SQ				

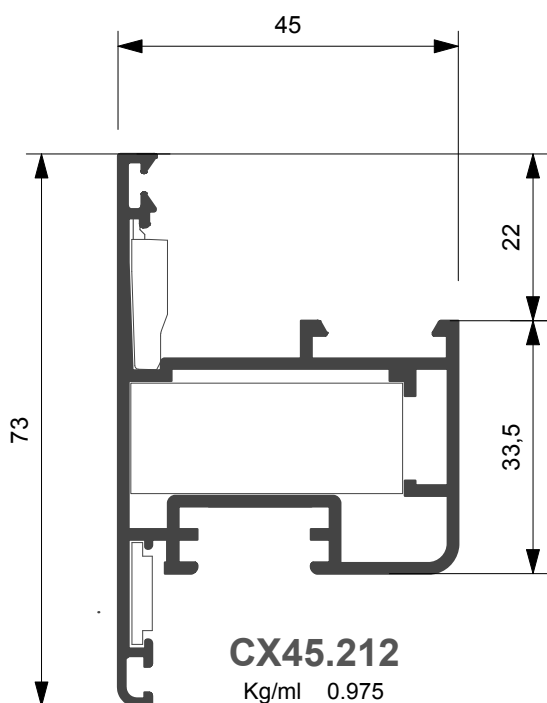

CX45.212
Kg/ml 0.975
--- mm. 115,0

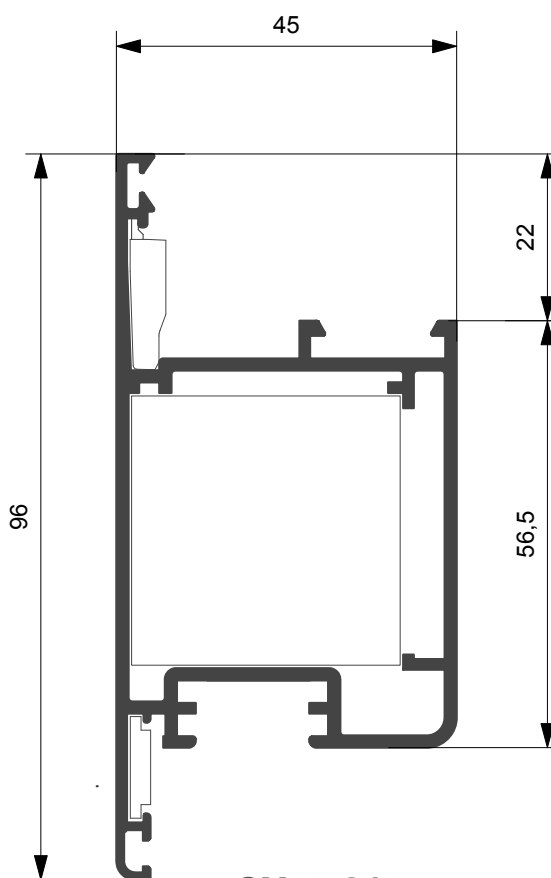

CX45.214
Kg/ml 1.265
--- mm. 156,0

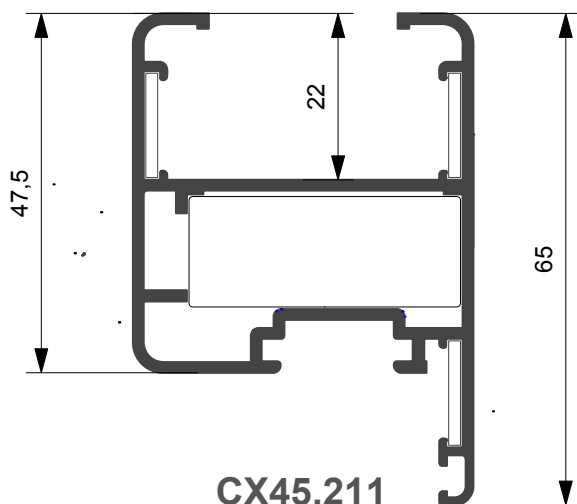
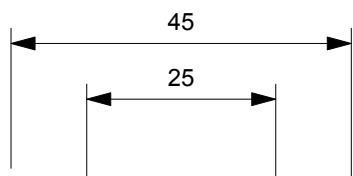

CX45.211
Kg/ml 0.960
--- mm. 123,0

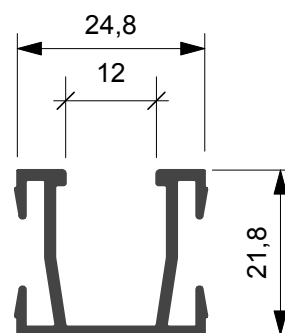

CX45.534
Kg/ml 0.321
--- mm. 38,0

Profilato	Squadretta esterna		Squadretta interna			Squadretta allineamento	
	Cianfrinare	Spinare	Bottone	Cianfrinare	Spinare	Esterna	Interna
CX45.211			ACX.21.SQ			ARX.10.SQ	ARX.10.SQ
CX45.212			ACX.21.SQ			ARX.15.SQ	ARX.10.SQ
CX45.214			ACX.22.SQ			ARX.15.SQ	ARX.10.SQ

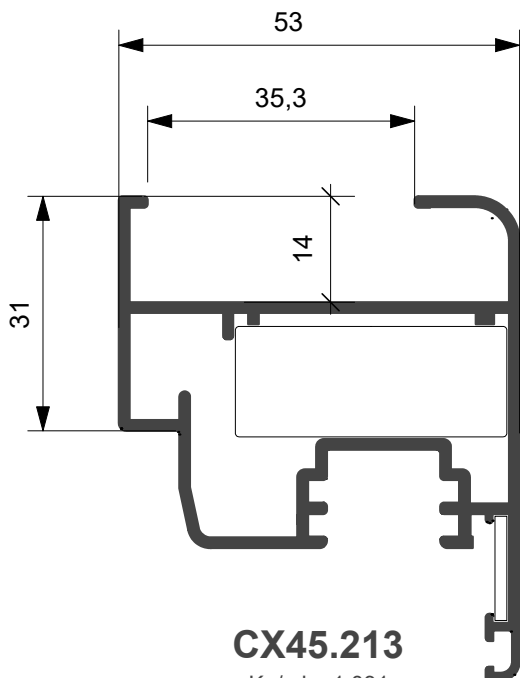

CX45.213

Kg/ml 1.031
--- mm. 108,0

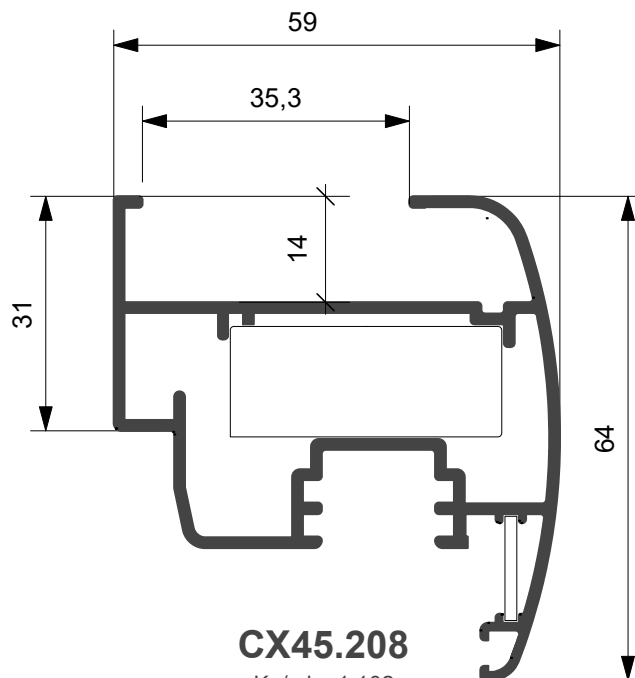

CX45.208

Kg/ml 1.102
--- mm. 115,0

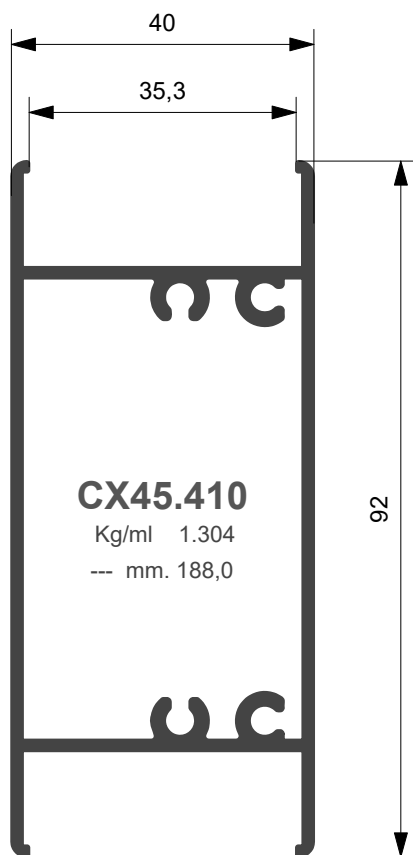

CX45.410

Kg/ml 1.304
--- mm. 188,0

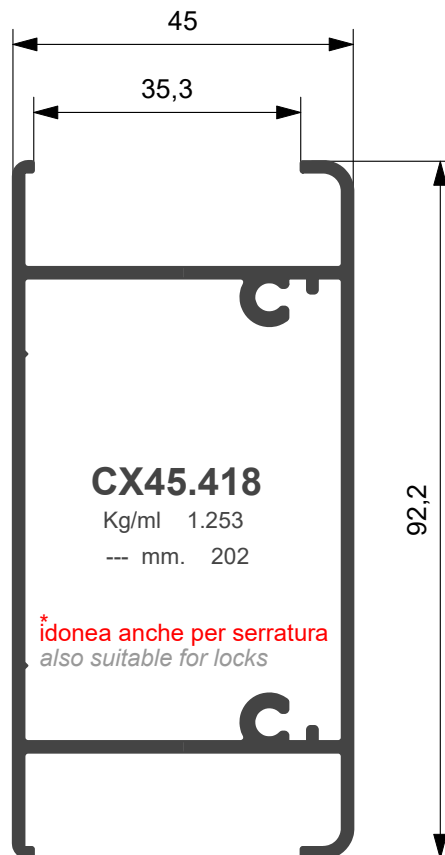

CX45.418

Kg/ml 1.253
--- mm. 202

* idonea anche per serratura
also suitable for locks

Profilato	Squadretta esterna		Squadretta interna			Squadretta allineamento	
	Cianfrinare	Spinare	Bottono	Cianfrinare	Spinare	Esterna	Interna
CX45.208			ACX.21.SQ				ARX.10.SQ
CX45.213			ACX.21.SQ				ARX.10.SQ

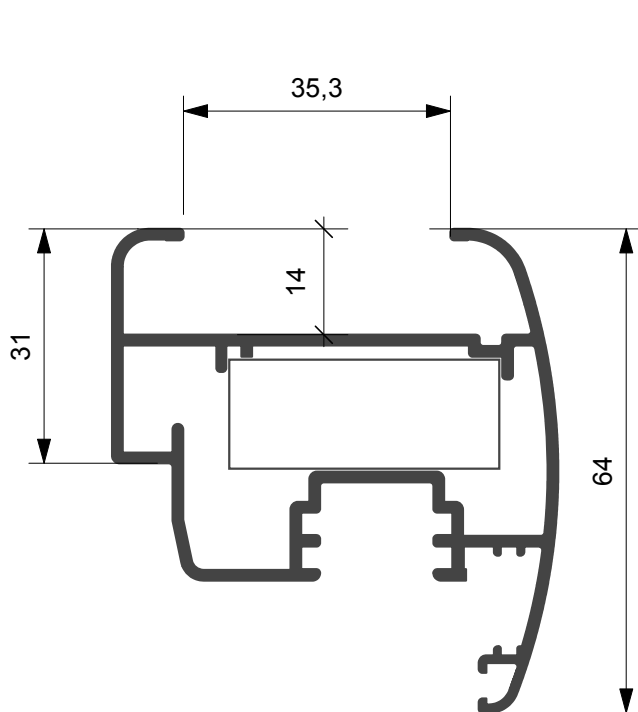

CX45.222

Kg/ml 1.100
--- mm. 115,0

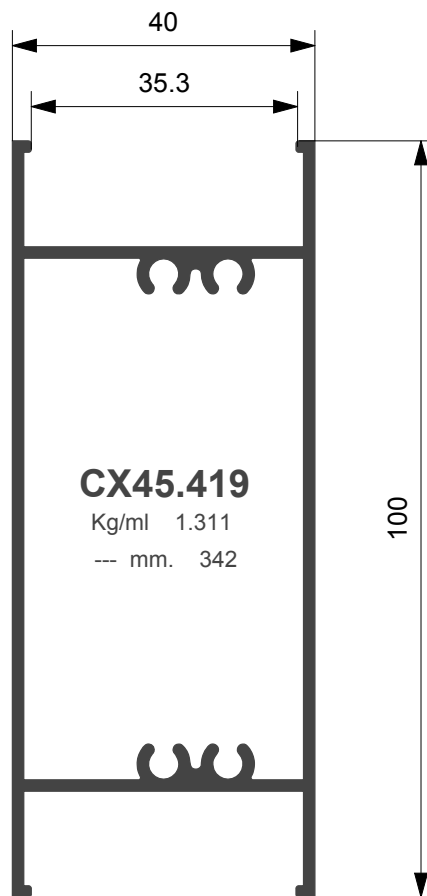

CX45.419

Kg/ml 1.311
--- mm. 342

Profilato	Squadretta esterna		Squadretta interna			Squadretta allineamento	
	Cianfrinare	Spinare	Bottone	Cianfrinare	Spinare	Esterna	Interna
CX45.222			ACX.21.SQ				ARX.10.SQ

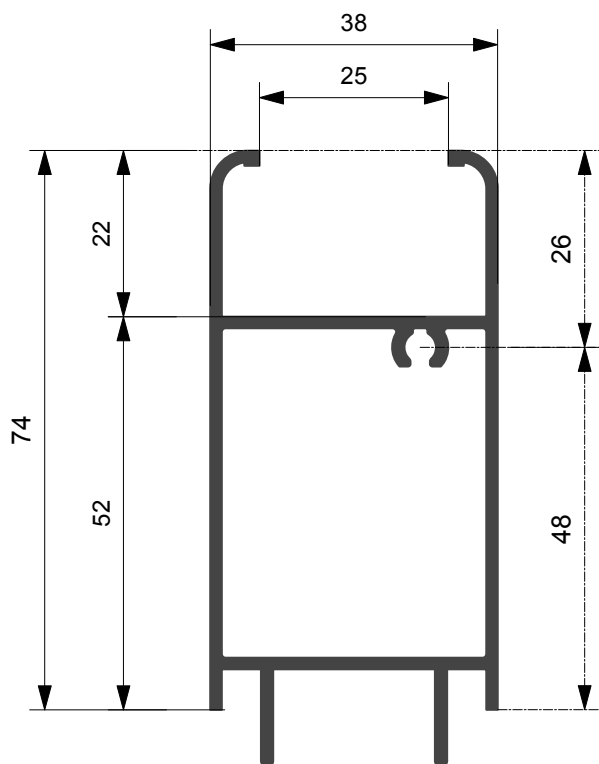

CX45.407
Kg/ml 1.074
--- mm. 158,0

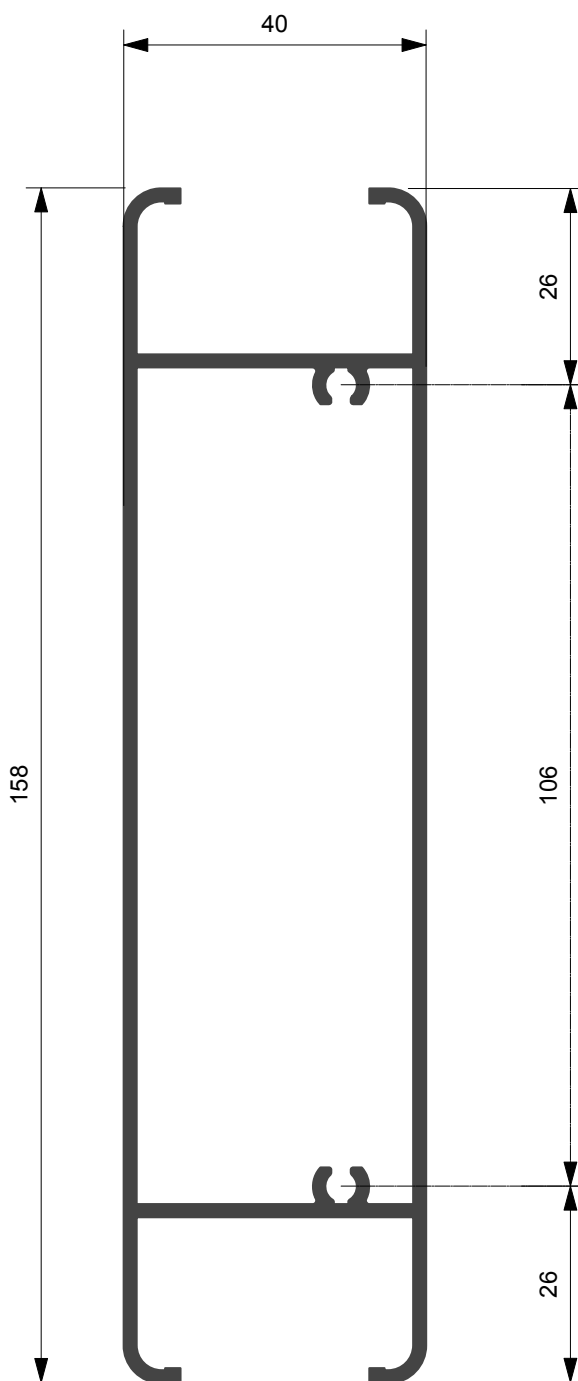

CX45.406
Kg/ml 1.960
--- mm. 326,0

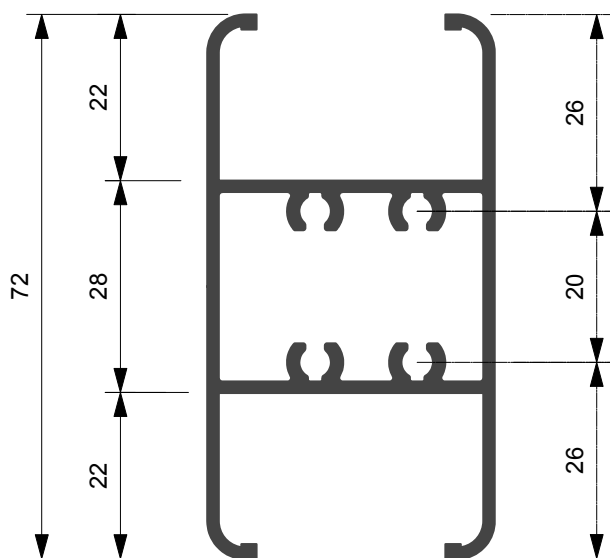

CX45.405
Kg/ml 1.126
--- mm. 164,0

Profilato	Squadretta esterna		Squadretta interna			Squadretta allineamento	
	Cianfrinare	Spinare	Bottone	Cianfrinare	Spinare	Esterna	Interna

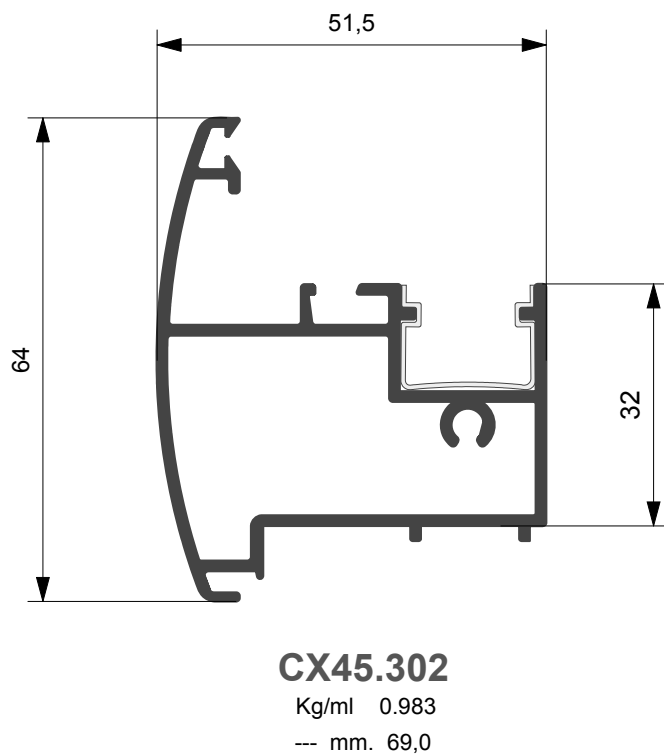
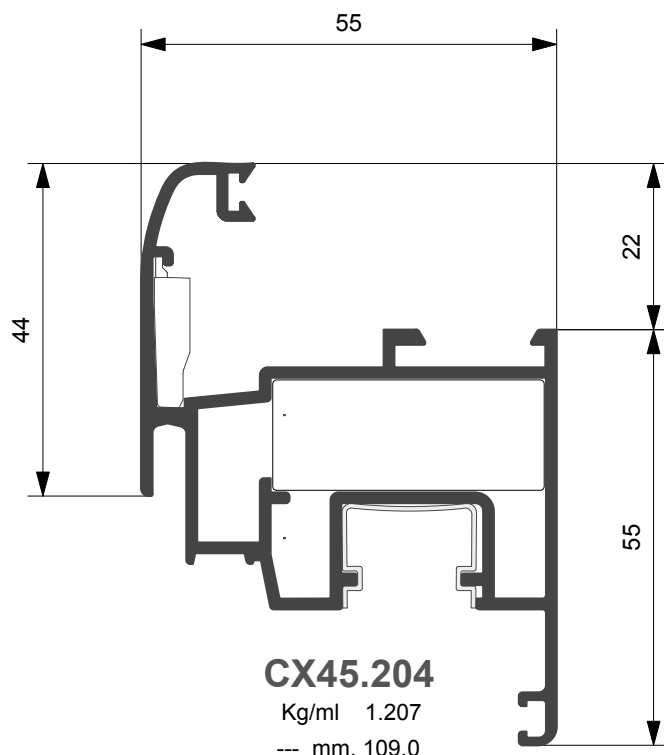

Profilato	Squadretta esterna		Squadretta interna			Squadretta allineamento	
	Cianfrinare	Spinare	Bottone	Cianfrinare	Spinare	Esterna	Interna
CX45.204			ACX.21.SQ			ARX.15.SQ	

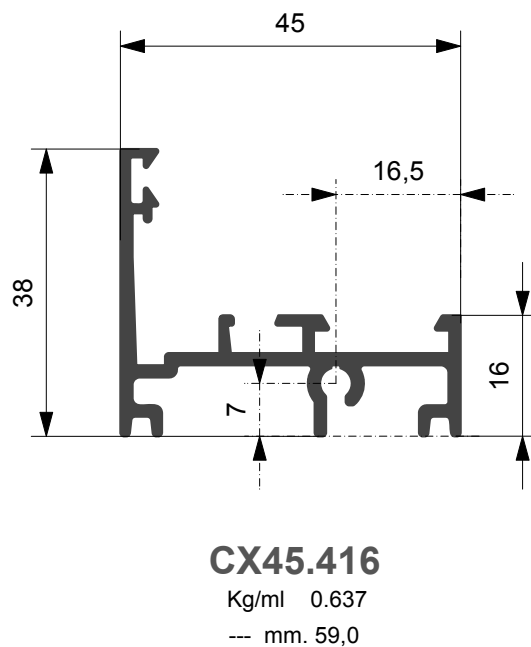
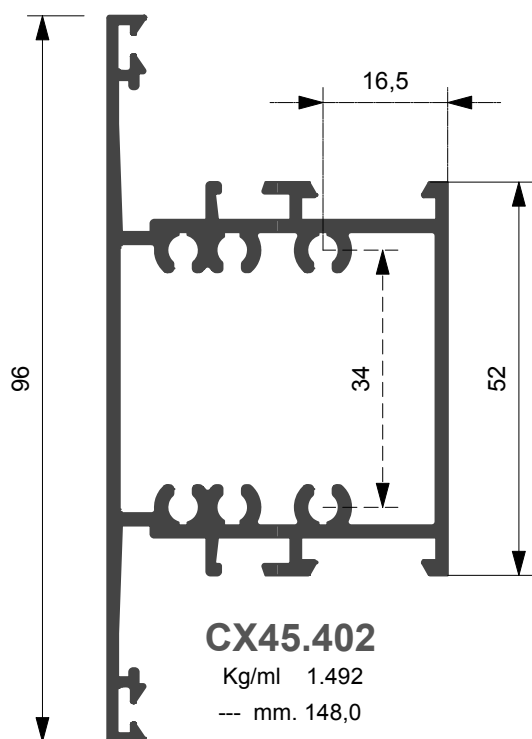
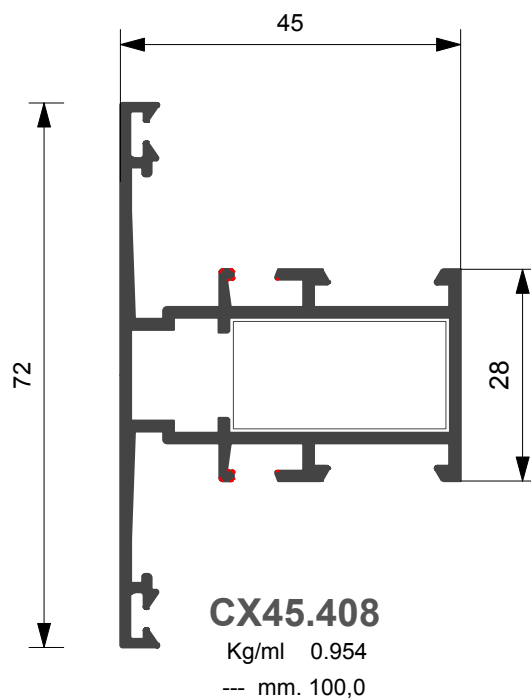
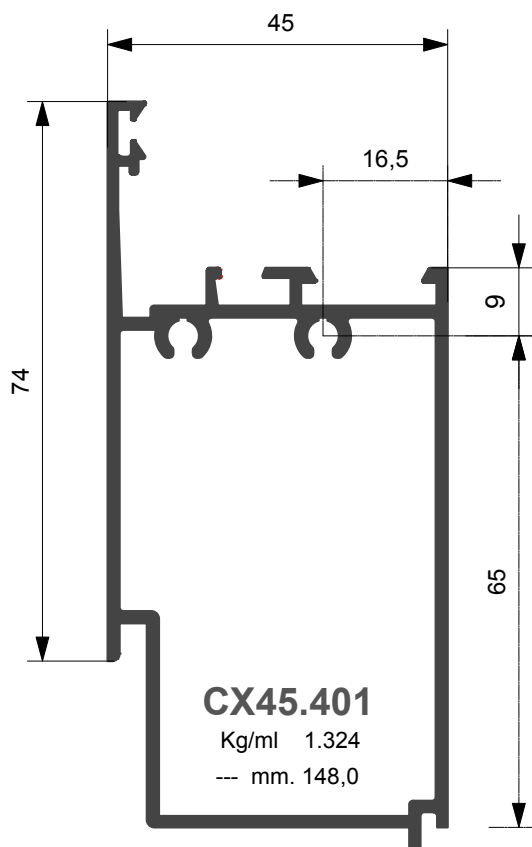

Profilato	Cavallotto	
	Esterno	Interno
CX45.408		ACX.12.SQ

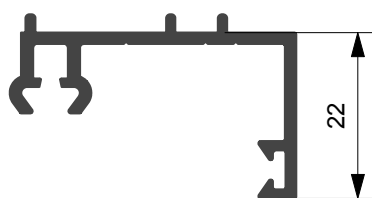
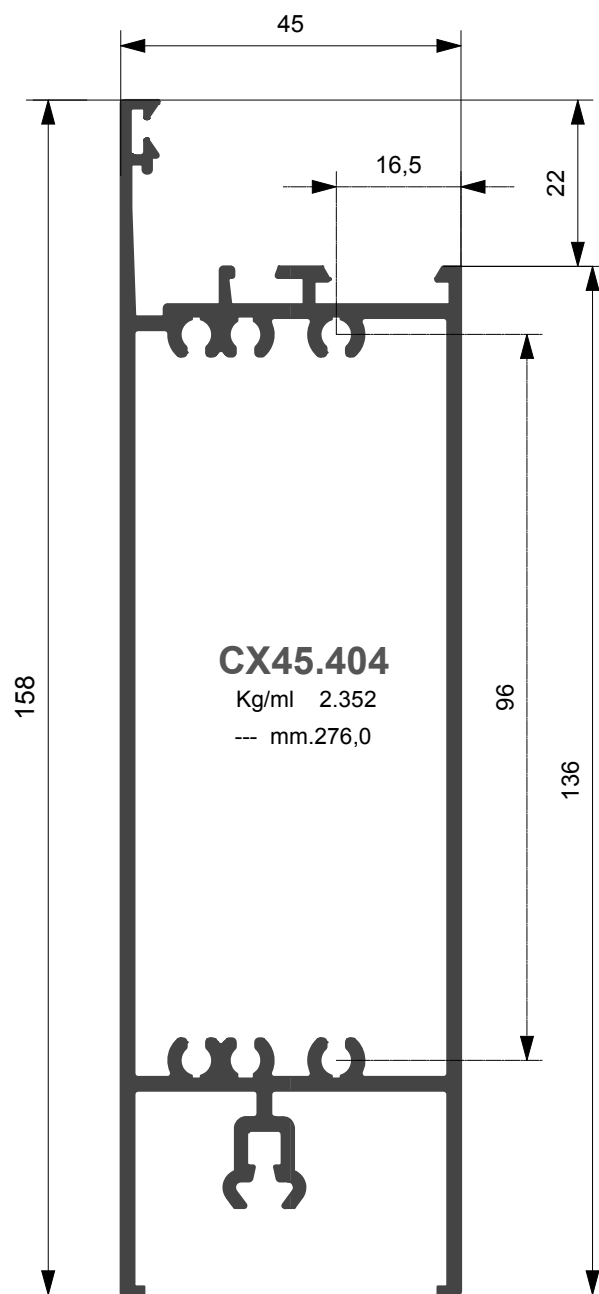
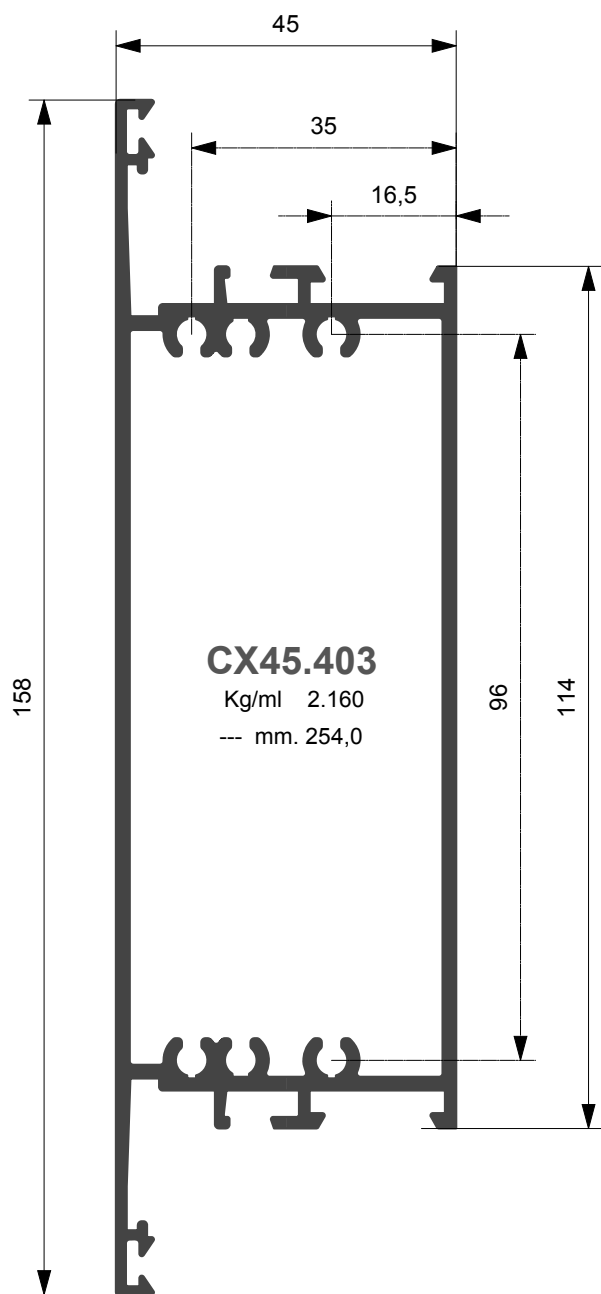

XX70.602
Kg/ml 0.372
--- mm. 22,0

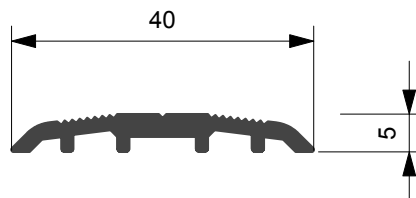

XX70.603
Kg/ml 0.275
--- mm. 40,0

Profilato	Squadretta esterna		Squadretta interna			Squadretta allineamento	
	Cianfrinare	Spinare	Bottone	Cianfrinare	Spinare	Esterna	Interna

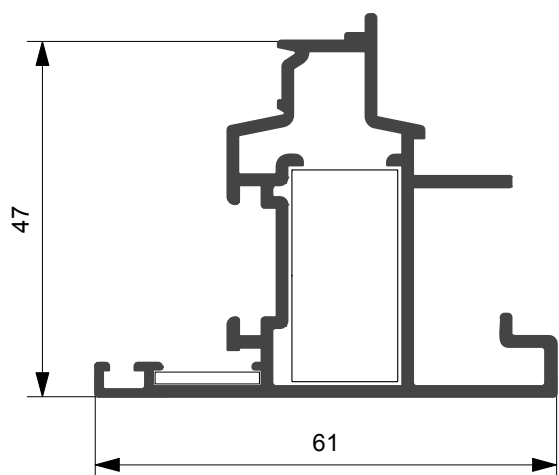

CX45.303

Kg/ml 0.913

--- mm. 61,0

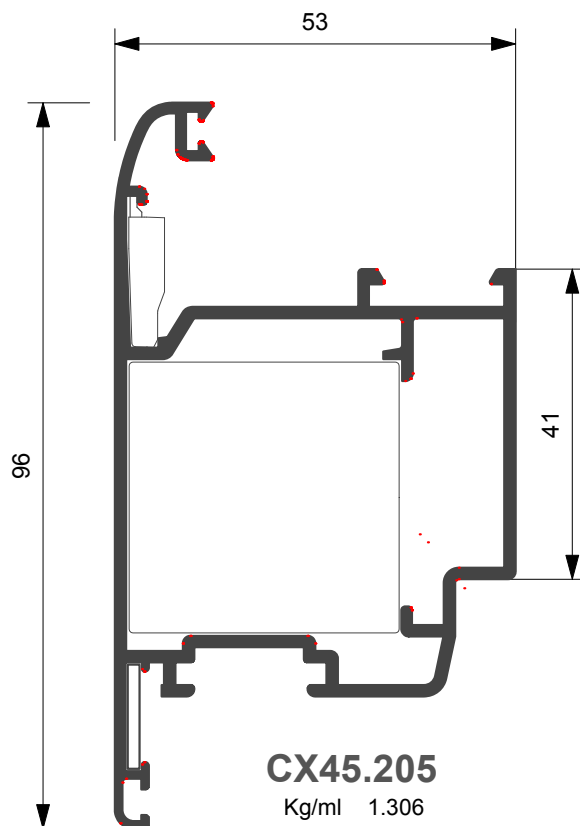

CX45.205

Kg/ml 1.306

--- mm. 147,0

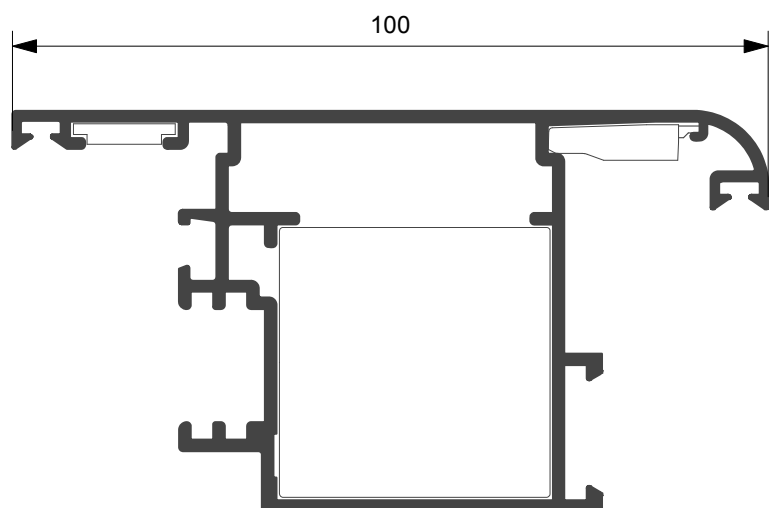

CX45.207

Kg/ml 1.383

--- mm. 155,0

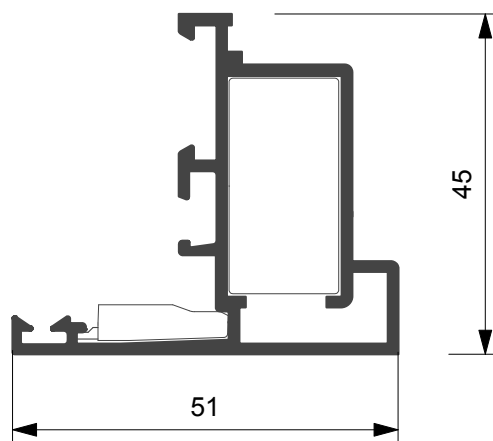

CX45.604

Kg/ml 0.761

--- mm. 58,0

Profilato	Squadretta esterna		Squadretta interna			Squadretta allineamento	
	Cianfrinare	Spinare	Bottone	Cianfrinare	Spinare	Esterna	Interna
CX45.303			ACX.01.SQ				ARX.10.SQ
CX45.205			ACX.22.SQ			ARX.15.SQ	ARX.10.SQ
CX45.207			ACX.22.SQ			ARX.15.SQ	ARX.10.SQ
CX45.604			ACX.01.SQ			ARX.15.SQ	ARX.10.SQ

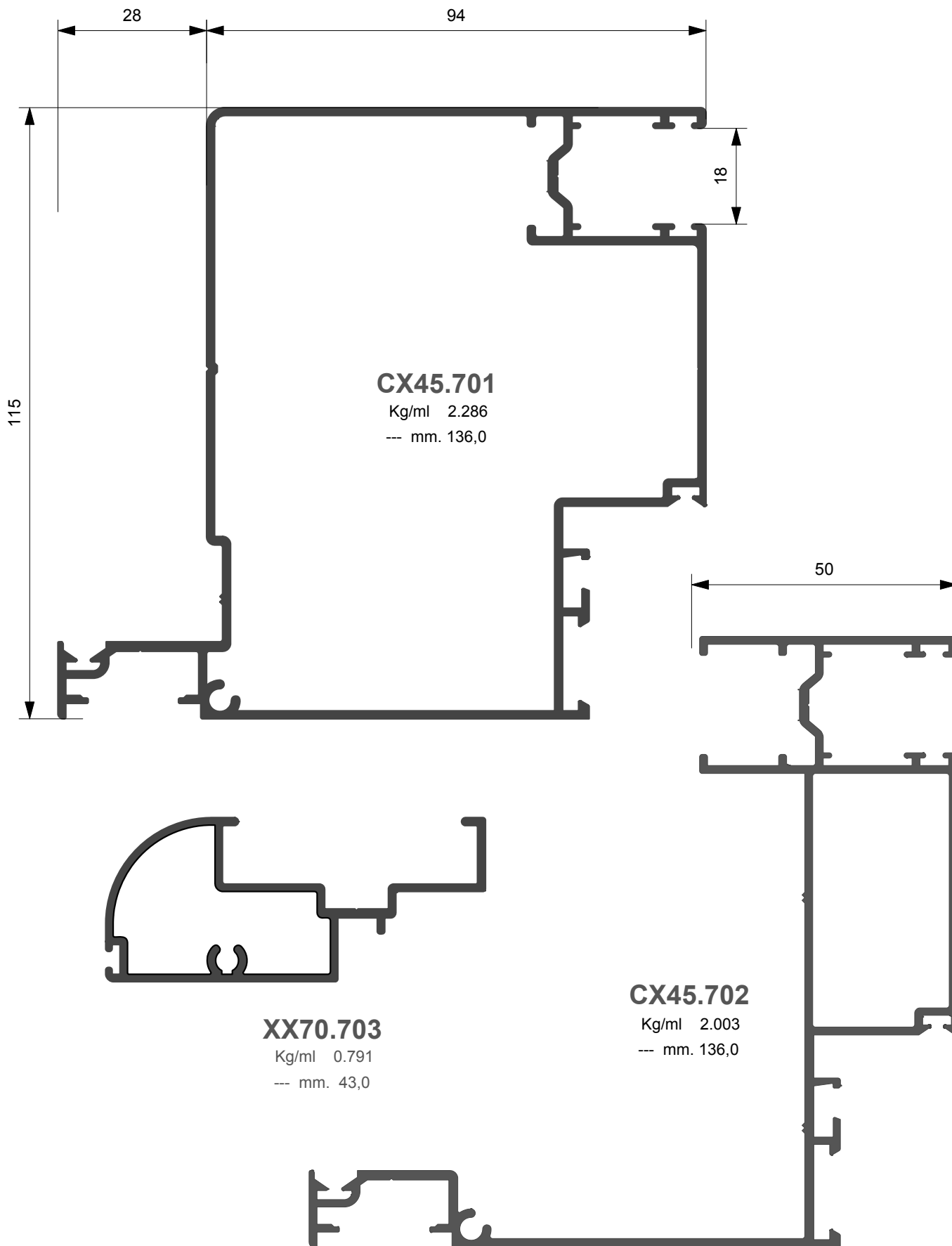

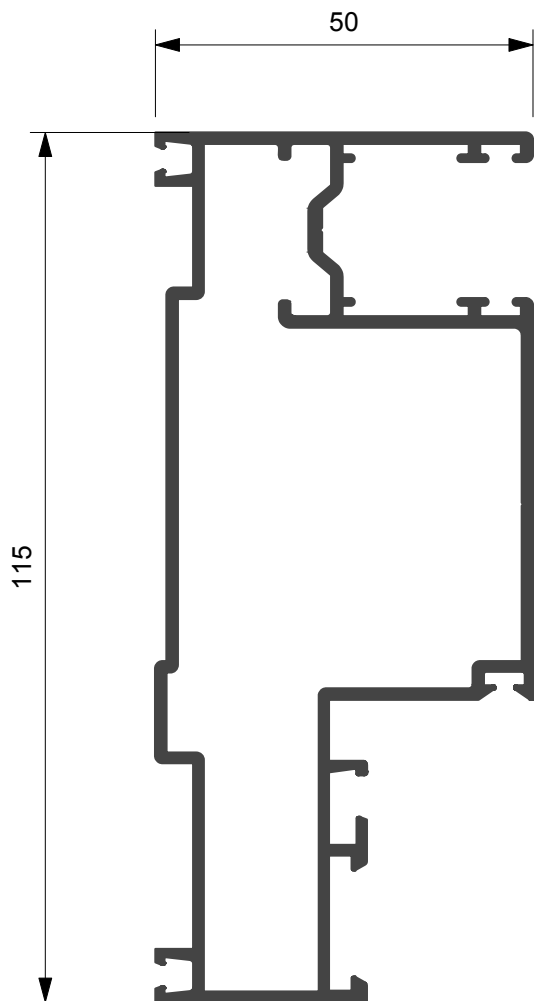

CX45.706

Kg/ml 1.680

--- mm. 85,0



XX70.705

Kg/ml 0.155

--- mm. 000,0

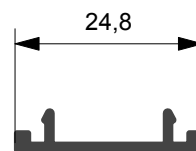

XX70.704

Kg/ml 0.135

--- mm. 25,0

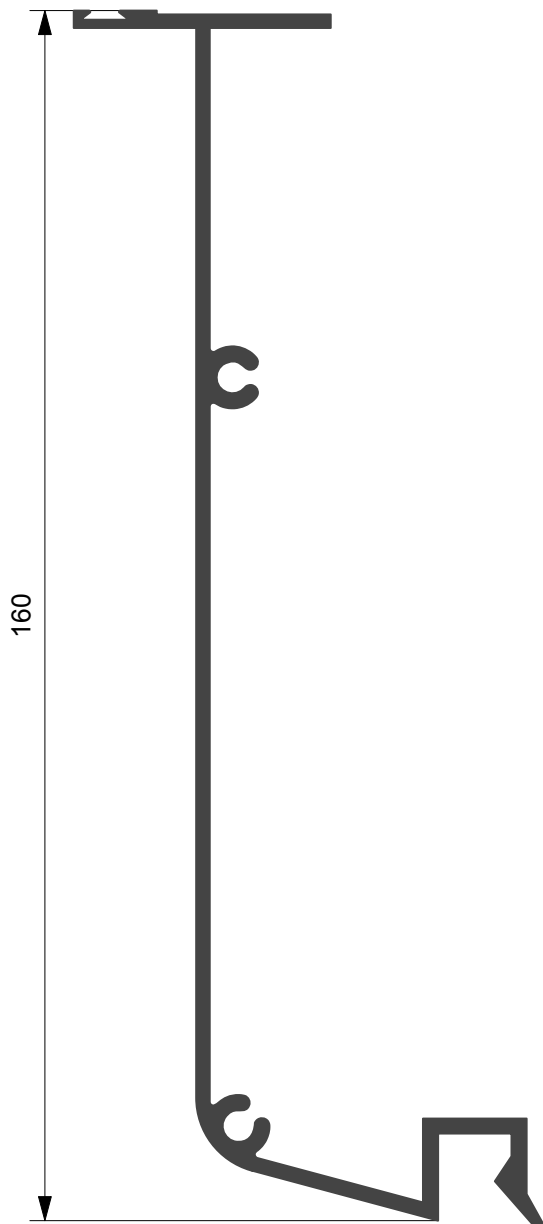

CX45.3363

Kg/ml 1.379

--- mm. 182,0

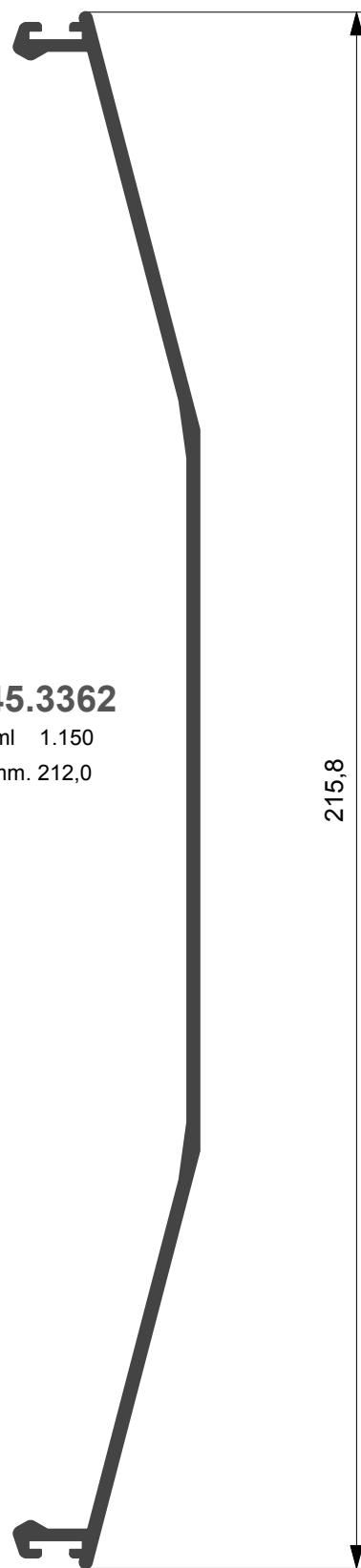

CX45.3362

Kg/ml 1.150

--- mm. 212,0

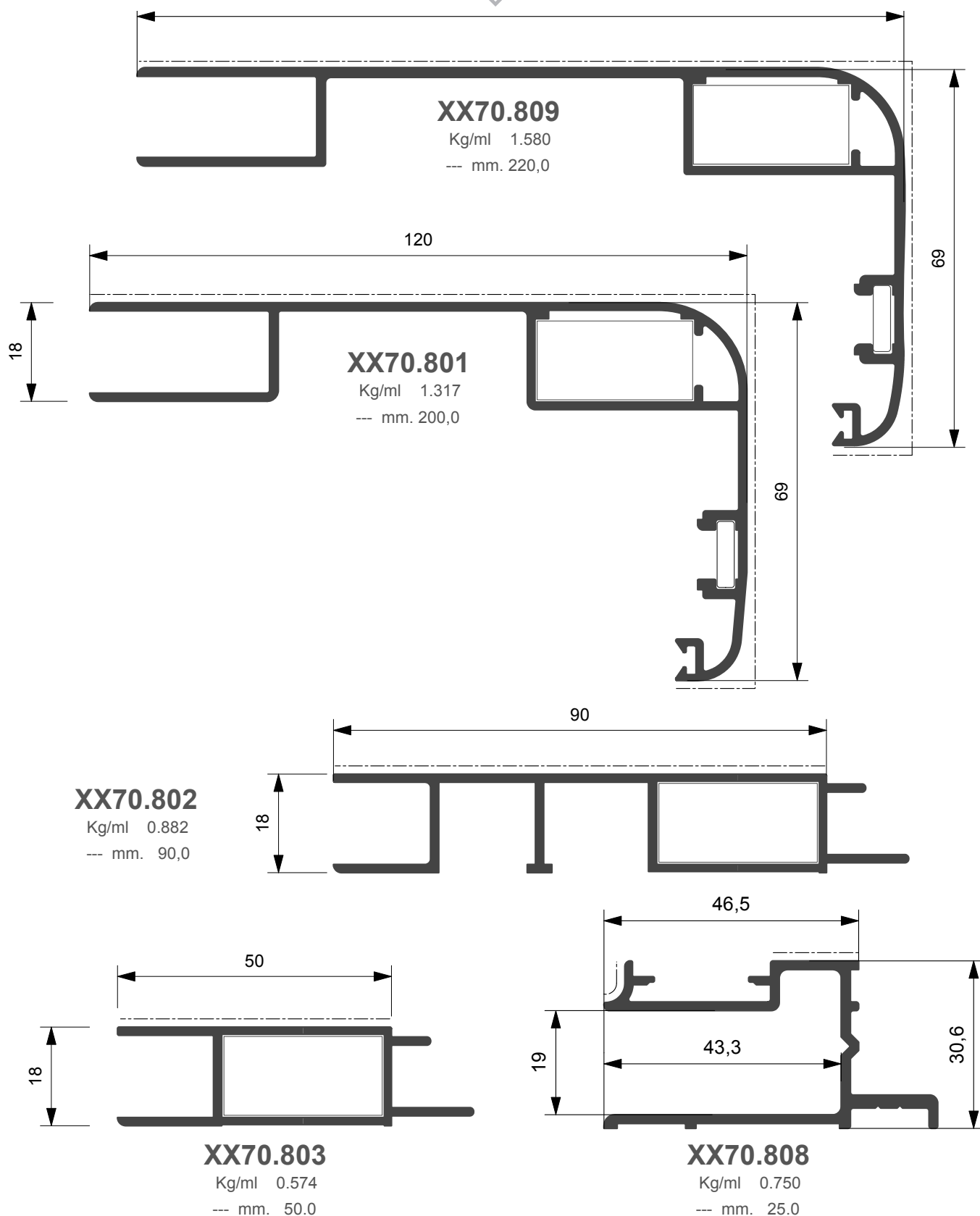

Profilato	Squadretta esterna		Squadretta interna			Squadretta allineamento	
	Bottone	Spinare	Bottone	Cianfrinare	Spinare	Esterna	Interna
XX70.801			ACX.01.SQ	ACX.02.SQ	ACX.02.SQ + ARX.07.SQ		ARX.11.SQ
XX70.802			ACX.01.SQ	ACX.02.SQ	ACX.02.SQ + ARX.07.SQ		
XX70.803			ACX.01.SQ	ACX.02.SQ	ACX.02.SQ + ARX.07.SQ		
XX70.809			ACX.01.SQ	ACX.02.SQ	ACX.02.SQ + ARX.07.SQ		ARX.11.SQ

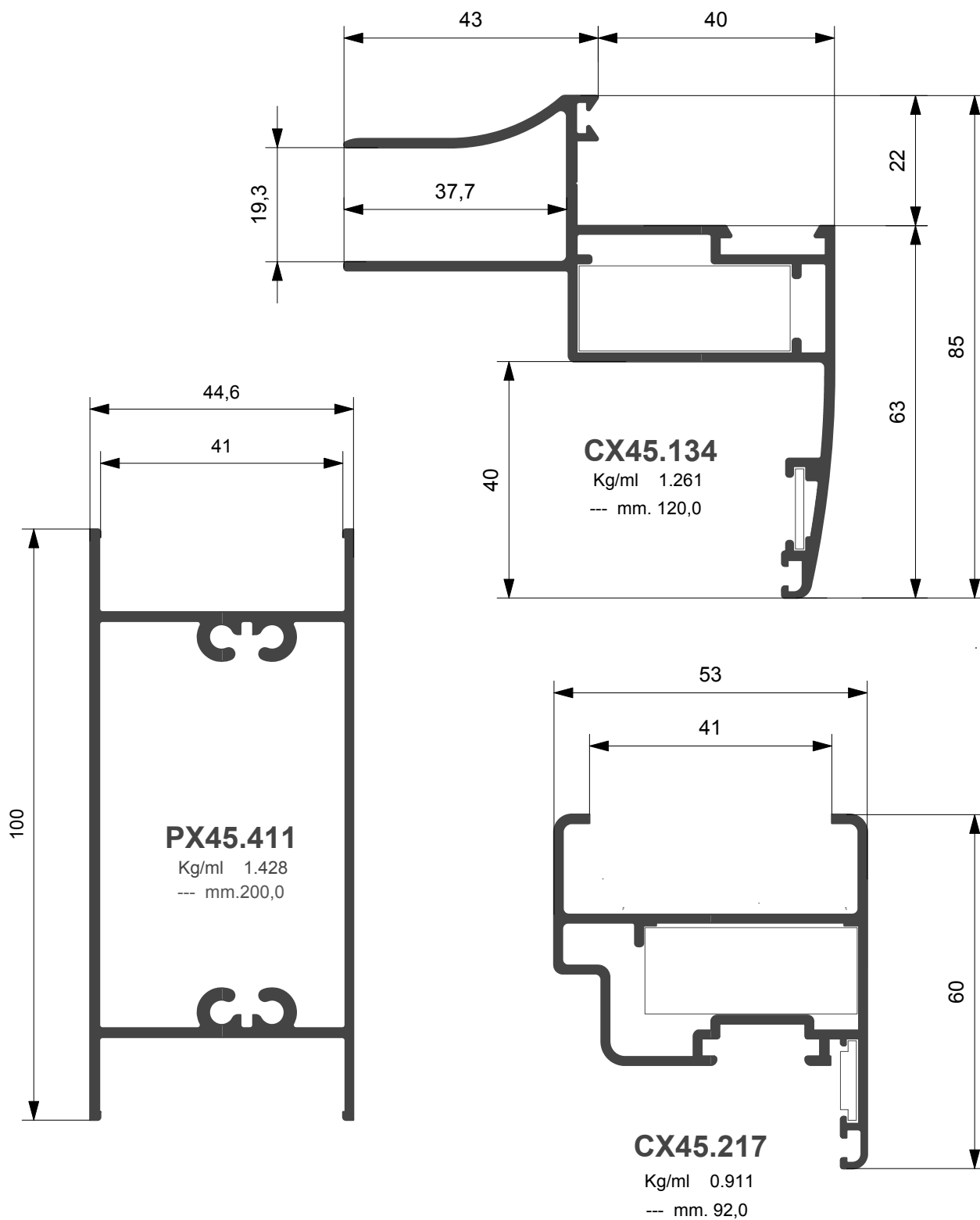

Profilato	Squadretta esterna		Squadretta interna			Squadretta allineamento	
	Bottone	Spinare	Bottone	Cianfrinare	Spinare	Esterna	Interna
CX45.134			ACX.21.SQ				ARX.10.SQ
CX45.217			ACX.21.SQ				ARX.10.SQ

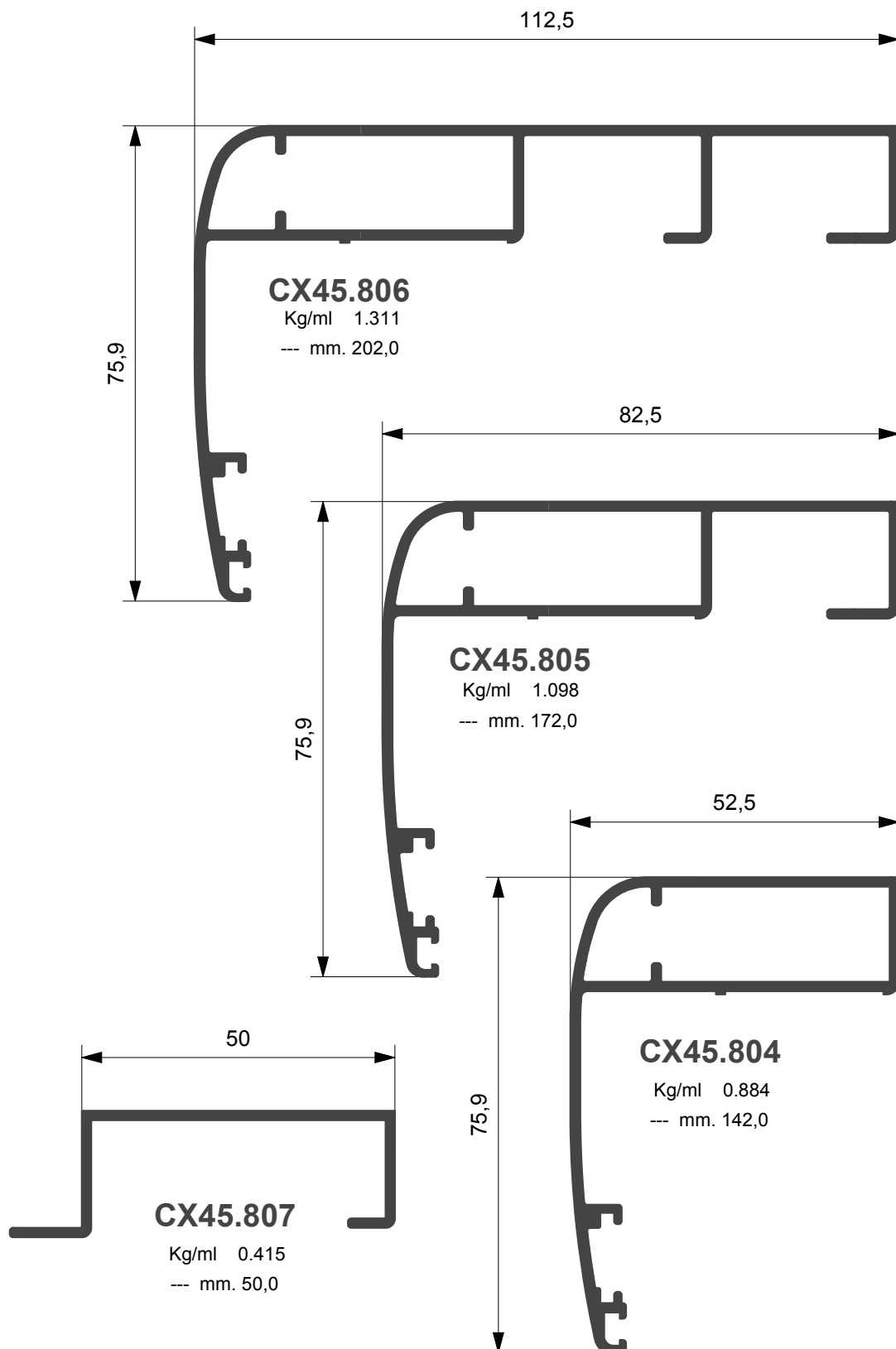

Profilato	Squadretta esterna		Squadretta interna			Squadretta allineamento	
	Bottone	Spinare	Bottone	Cianfrinare	Spinare	Esterna	Interna
CX45.804			ACX.21.SQ				ARX.10.SQ
CX45.805			ACX.21.SQ				ARX.10.SQ
CX45.806			ACX.21.SQ				ARX.10.SQ

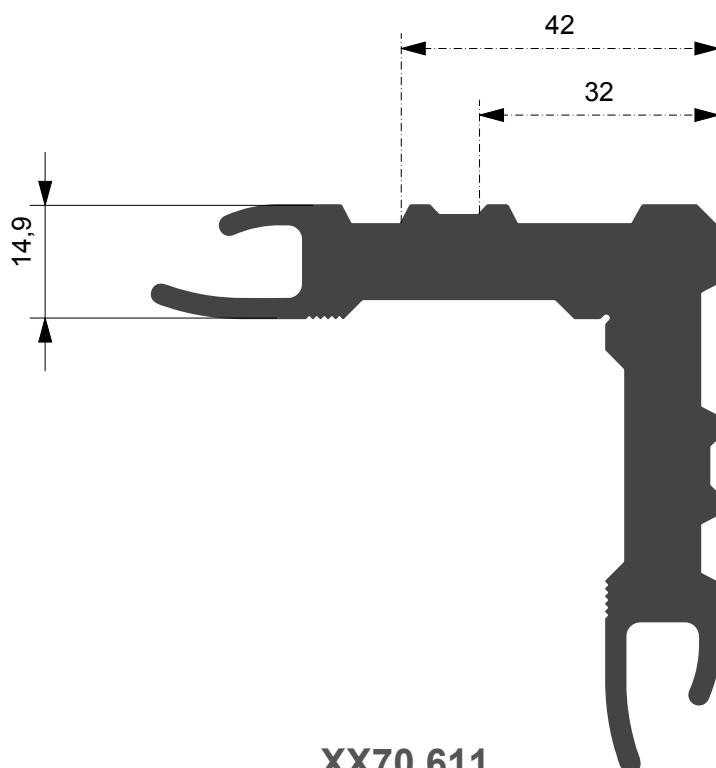

XX70.611

Kg/ml 3.426

--- mm. 00,0

Profilato	Squadretta esterna		Squadretta interna			Squadretta allineamento	
	Cianfrinare	Spinare	Bottone	Cianfrinare	Spinare	Esterna	Interna

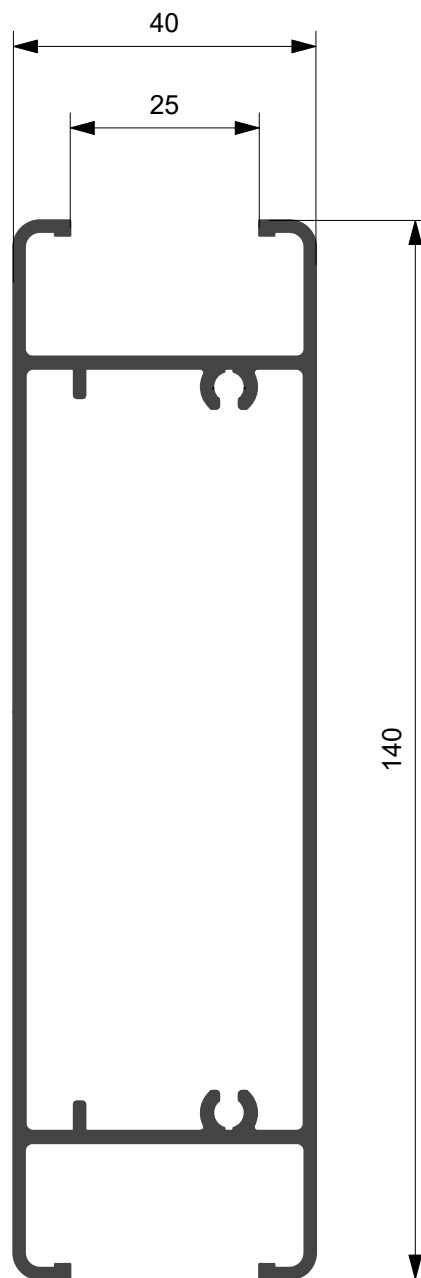
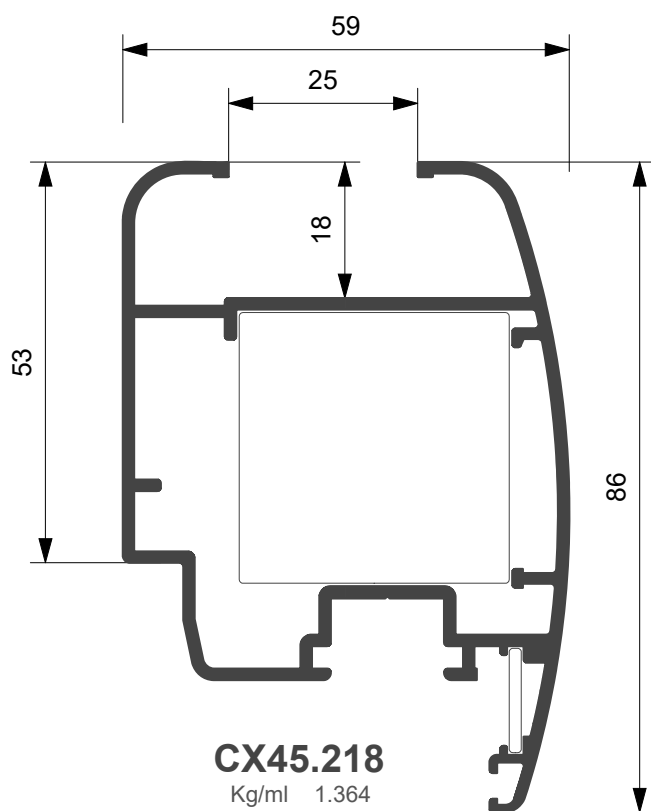
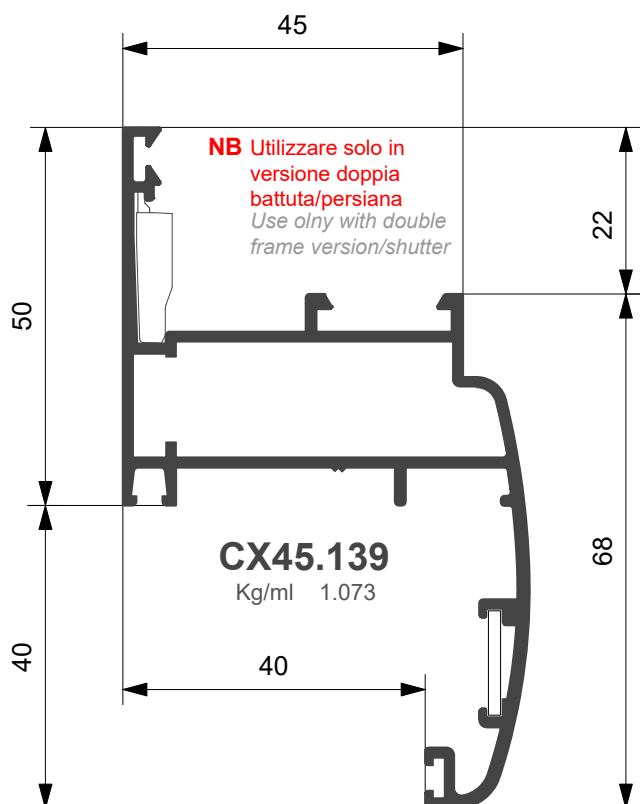

Profilato	Squadretta esterna		Squadretta interna			Squadretta allineamento	
	Cianfrinare	Spinare	Bottone	Cianfrinare	Spinare	Esterna	Interna
CX45.139			ACX.21.SQ			ARX.15.SQ	ARX.10.SQ
CX45.218			ACX.22.SQ				ARX.10.SQ

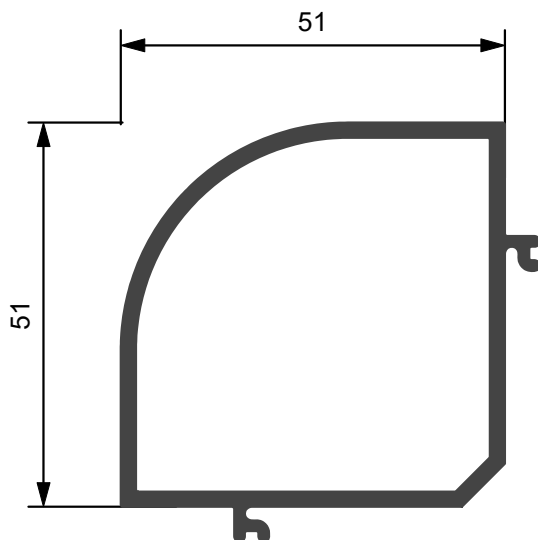

RX450.9525

Kg/ml 1,037

--- mm. 96

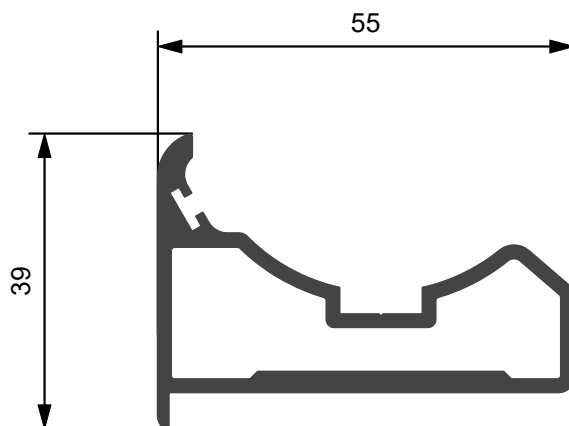

RX450.3570

Kg/ml 0,922

--- mm. 60

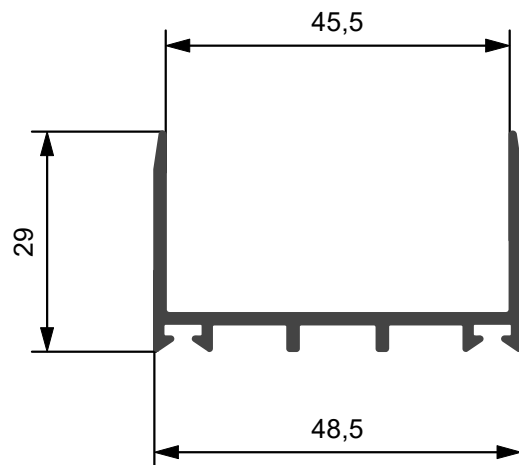

RX450.9303

Kg/ml 0,462

--- mm. 58

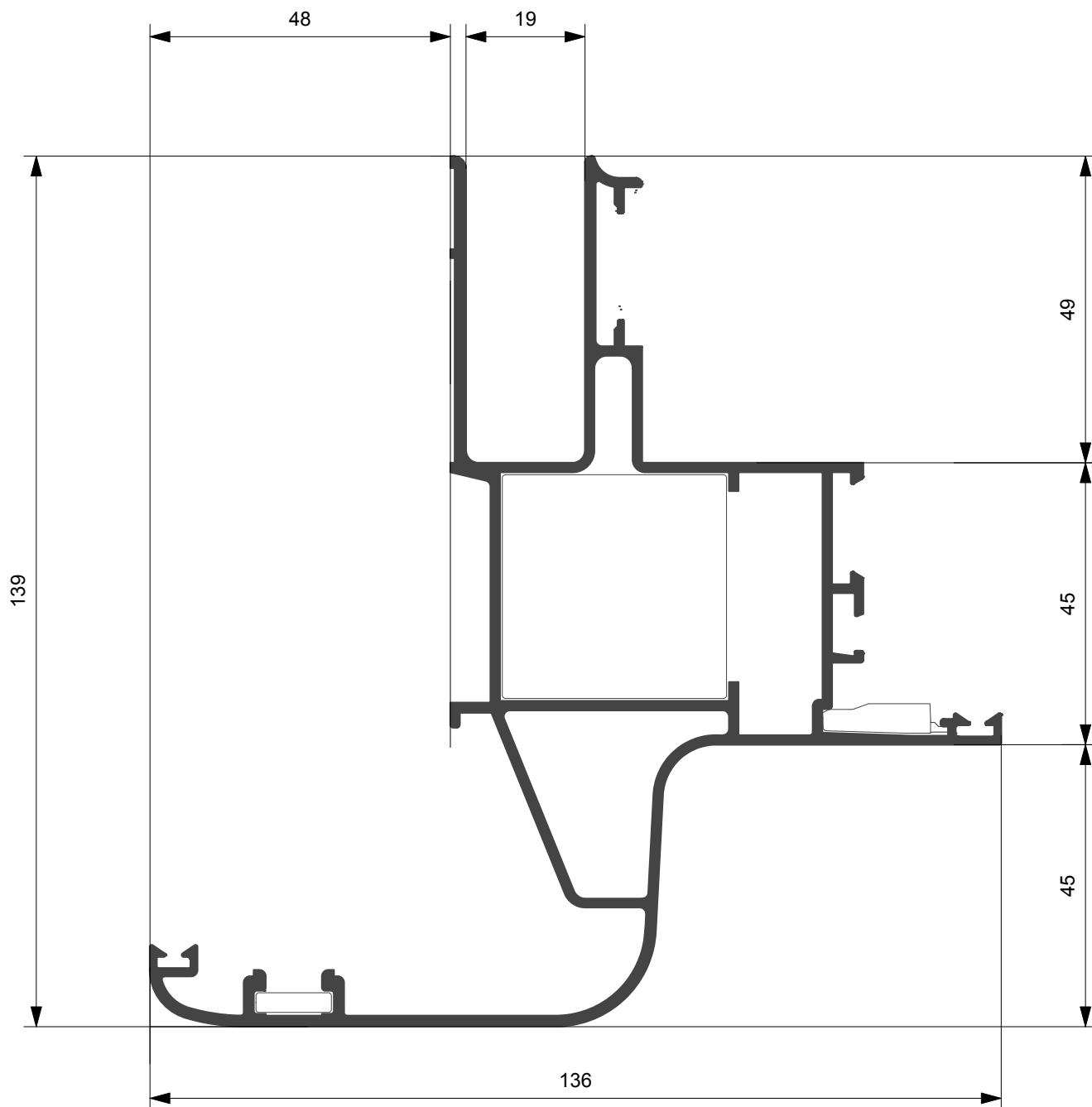

CX45.109

Kg/ml 2.610

--- mm. 242,0

Profilato	Squadretta esterna		Squadretta interna			Squadretta allineamento	
	Cianfrinare	Spinare	Bottone	Cianfrinare	Spinare	Esterna	Interna
CX45.109			ACX.22.SQ			ARX.15.SQ	ARX.11.SQ



CX70.521

Kg/ml 0.266
--- mm. 36,0

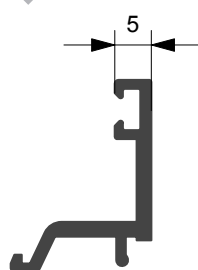
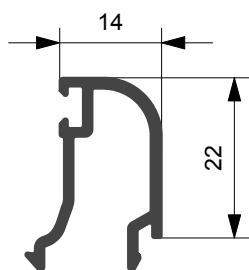

CX70.533

Kg/ml 0.252
--- mm. 27,0

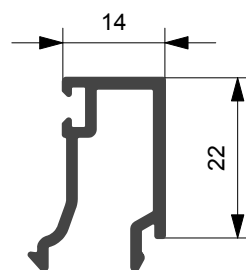

CX70.526

Kg/ml 0.279
--- mm. 36,0

CX70.522

Kg/ml 0.277
--- mm. 40,0

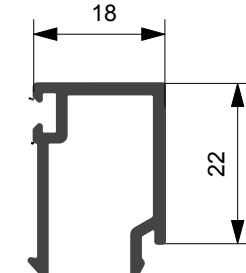
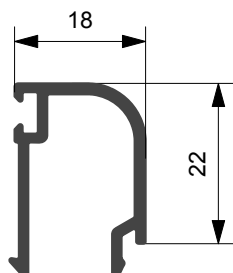

CX70.527

Kg/ml 0.290
--- mm. 40,0

CX70.523

Kg/ml 0.294
--- mm. 44,0

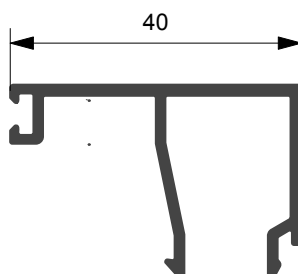
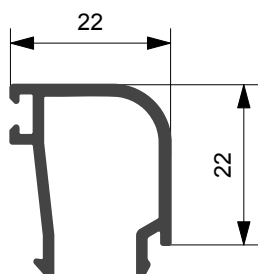

CX70.537

Kg/ml 0.403
--- mm. 62,0

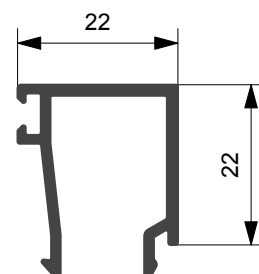

CX70.528

Kg/ml 0.307
--- mm. 44,0

CX70.524

Kg/ml 0.314
--- mm. 48,0

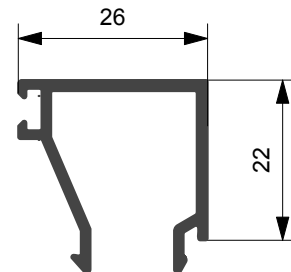
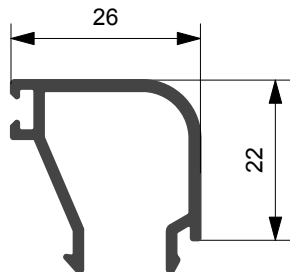

CX70.529

Kg/ml 0.327
--- mm. 48,0

CX70.525

Kg/ml 0.350
--- mm. 52,0

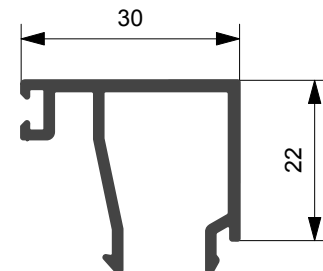
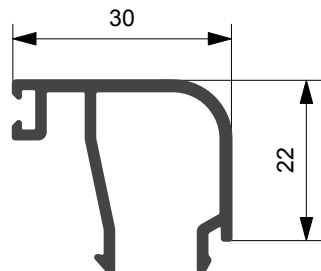

CX70.530

Kg/ml 0.362
--- mm. 52,0

CX70.531

Kg/ml 0.370
--- mm. 57,0

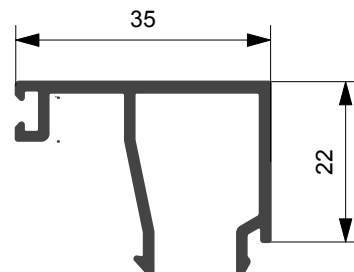
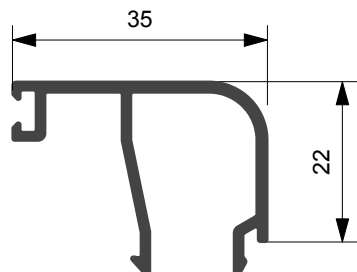

CX70.532

Kg/ml 0.383
--- mm. 57,0



CX70.571

Kg/ml 0.216
--- mm. 36,0

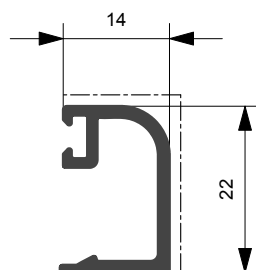

CX70.572

Kg/ml 0.262
--- mm. 40,0

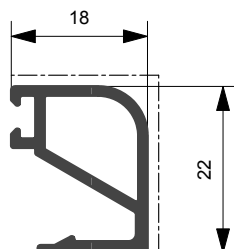

CX70.573

Kg/ml 0.283
--- mm. 44,0

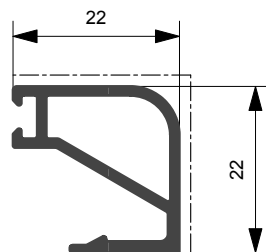

CX70.574

Kg/ml 0.313
--- mm. 48,0

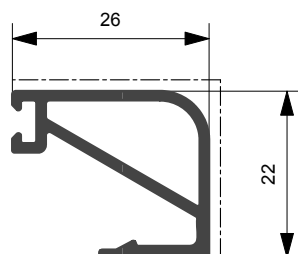

CX70.575

Kg/ml 0.340
--- mm. 52,0

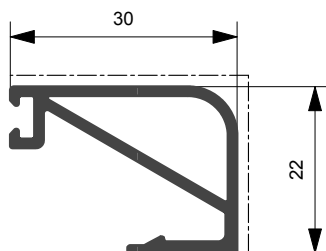



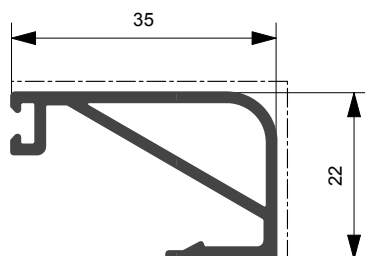

RX70.581

Kg/ml 0.361
--- mm. 57,0





Aletta Flap (a) mm.	Vuoto Gap (v) mm.	Fermavetro Glazing Beads (f) mm.	Codice Fermavetro Glazing Bead CODE D=dritto/straight T=tondo/rounded		Guarnizione Est. External Gasket mm.	Guarnizioni interne vetro Gaskets for Internal Glazing								
			ARX.10.15 	ARX.10.14 		ARX.10.13 	ARX.10.12 	mm.10	mm.9	mm.8	mm.7	mm.6	mm.5	mm.4
Vetrazione [Glazing] (spessore vetro in mm./Glass Width in mm.)														
5	10	30	D	CX70.530	3	-	-	-	-	-	-	-	-	4
			T	CX70.525										
5	14	26	D	CX70.529	3	-	-	-	4	5	6	7	8	
			T	CX70.524										
5	18	22	D	CX70.528	3	5	6	7	8	9	10	11	12	
			T	CX70.523										
5	22	18	D	CX70.527	3	8	9	10	11	12	13	15	16	
			T	CX70.522										
5	26	14	D	CX70.526	3	13	14	15	16	17	18	19	20	
			T	CX70.521										
5	35	5	D	CX70.533	3	22	23	24	25	26	27	28	29	
			T											

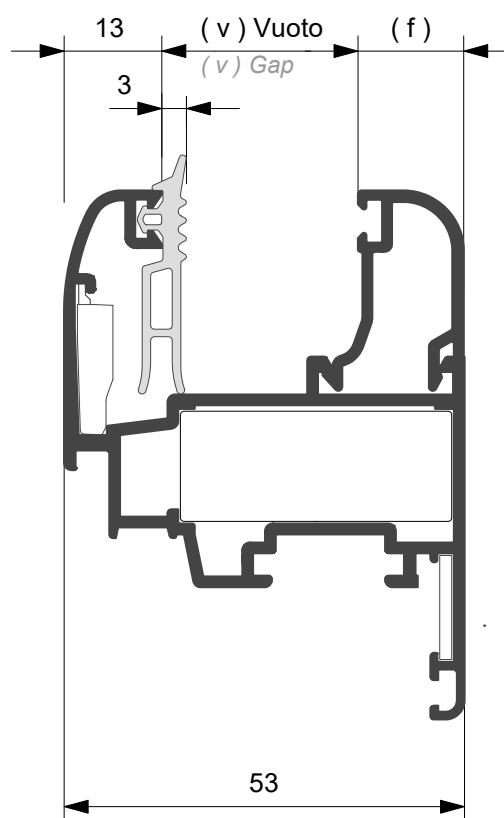
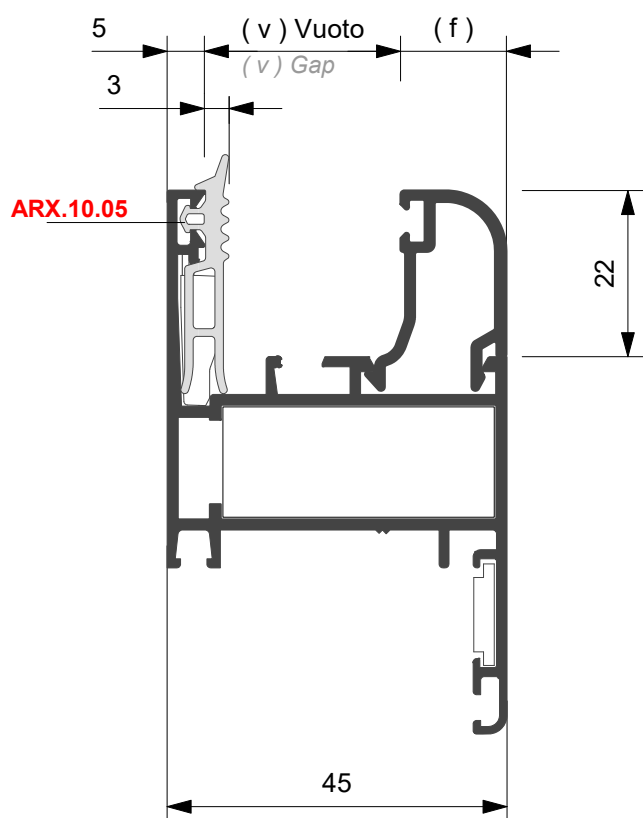

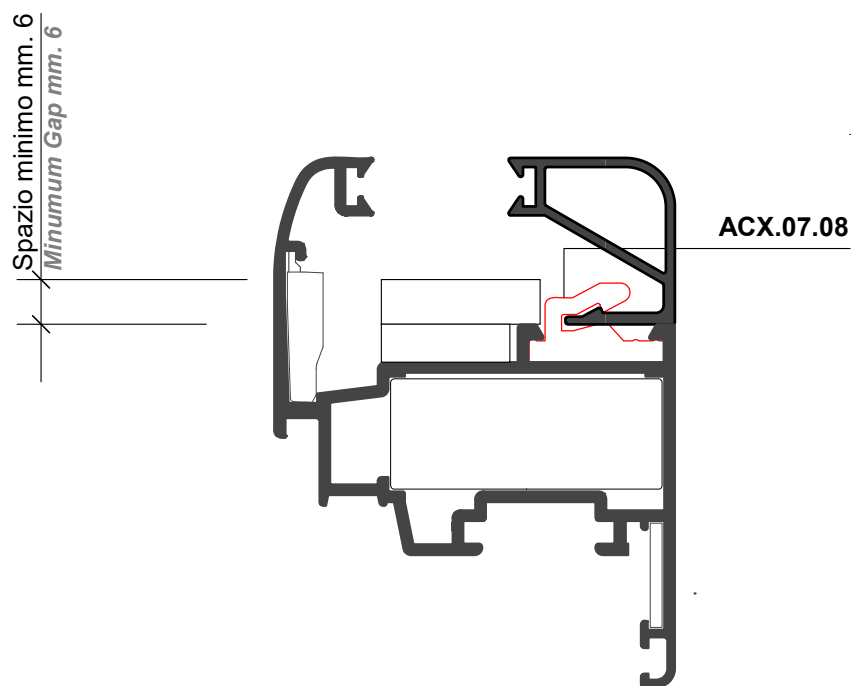
**APPLICAZIONE FERMAVETRI CON CLIPS**
GLAZING BEADS APPLICATION WITH CLIPS

E' consigliabile l'abbinamento con fermavetri tradizionali con taglio a 45° ,al fine di evitare gli angoli/fermavetro in zama

Combination with traditional glazing beads is recommended with 45 ° cut, in order to avoid zamak corners/glazing beads



Linea **elite**

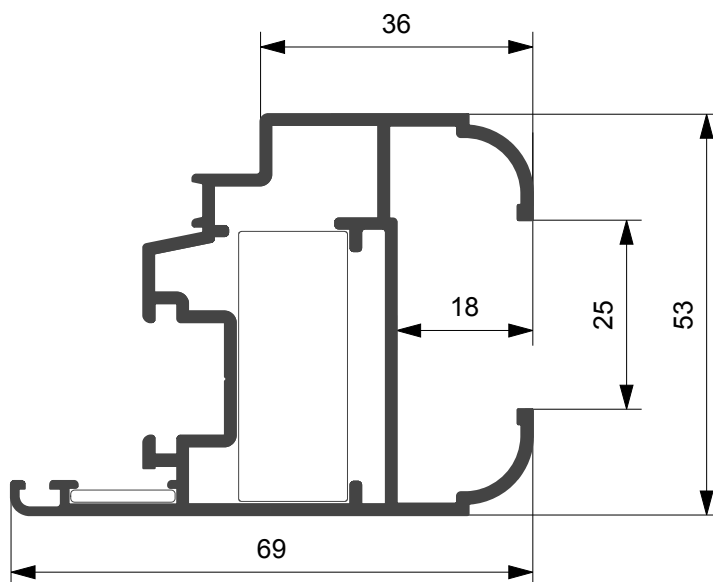

CX45.253

Kg/ml 1.090
--- mm. 135,0

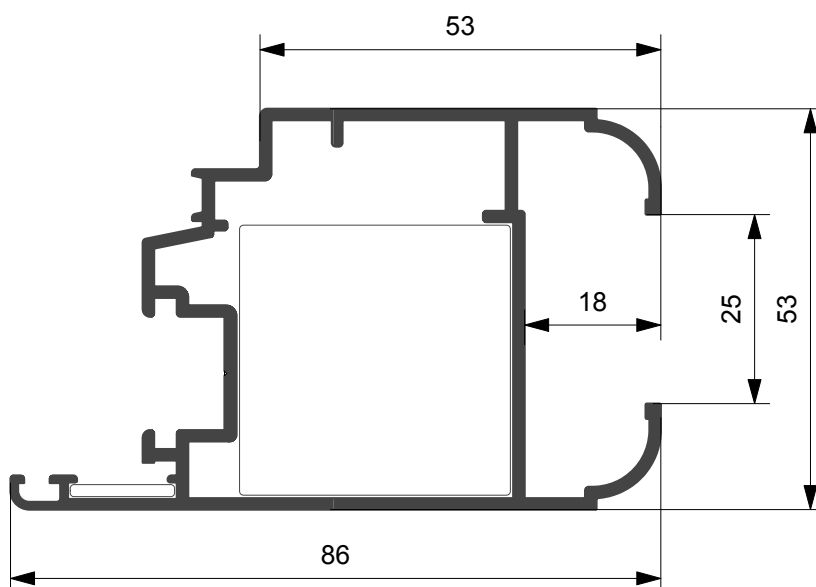

CX45.256

Kg/ml 1.262
--- mm. 169,0

Profilato	Squadretta esterna		Squadretta interna			Squadretta allineamento	
	Cianfrinare	Spinare	Bottone	Cianfrinare	Spinare	Esterna	Interna
CX45.253			ACX.21.SQ				ARX.10.SQ
CX45.256			ACX.22.SQ				ARX.10.SQ



Linea **elite**

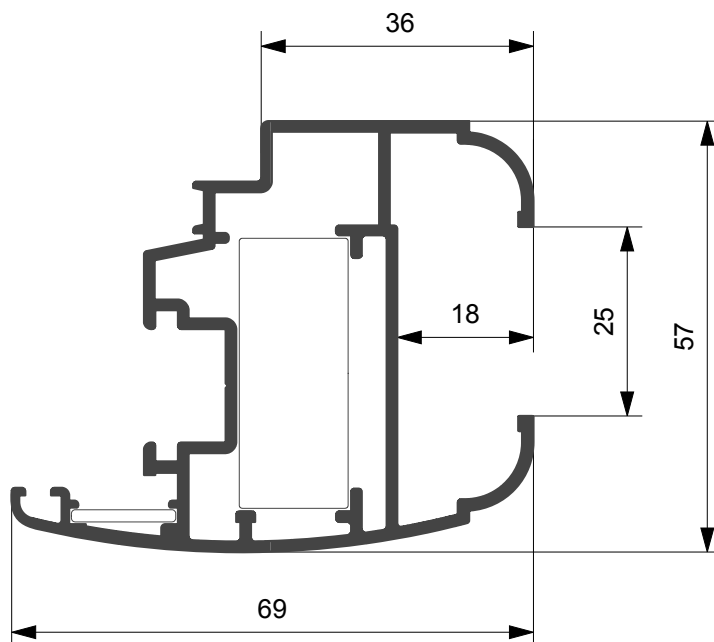

CX45.259

Kg/ml 1.179
--- mm. 140,0

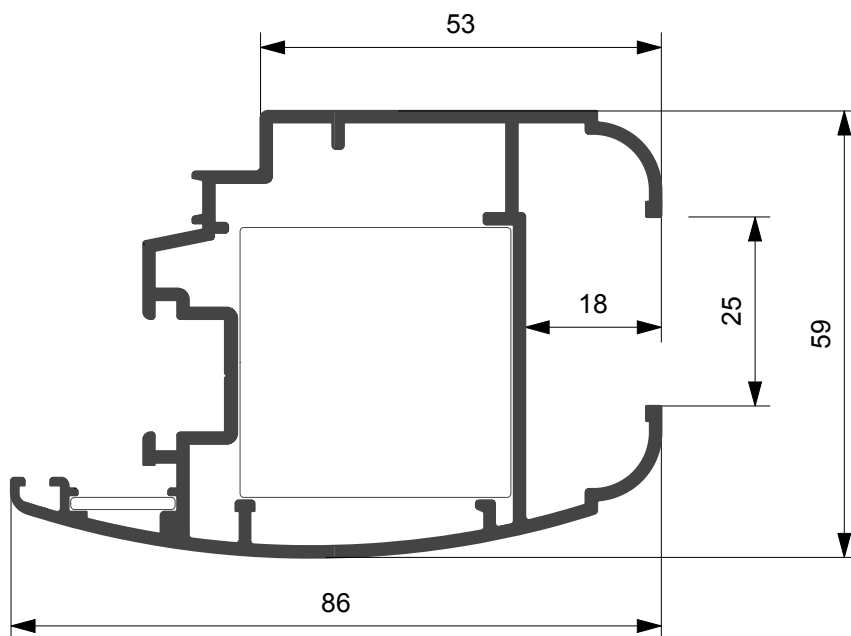

CX45.250

Kg/ml 1.374
--- mm. 178,0

Profilato	Squadretta esterna PESO 1.374 Kg/ml		Squadretta interna			Squadretta allineamento	
	Cianfrinare	Spinare	Bottono	Cianfrinare	Spinare	Esterna	Interna
CX45.259			ACX.21.SQ				ARX.10.SQ
CX45.250			ACX.22.SQ				ARX.10.SQ



Linea elite

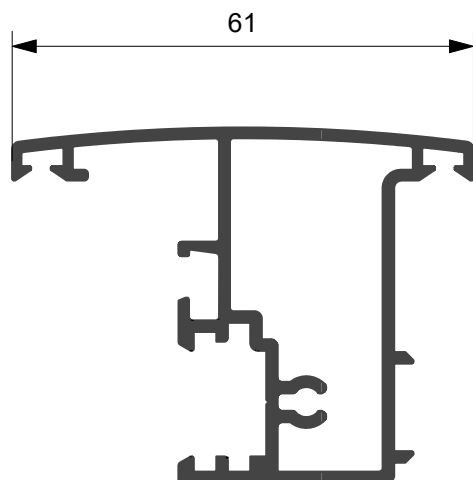

CX45.351

Kg/ml 0.953

--- mm. 102,0

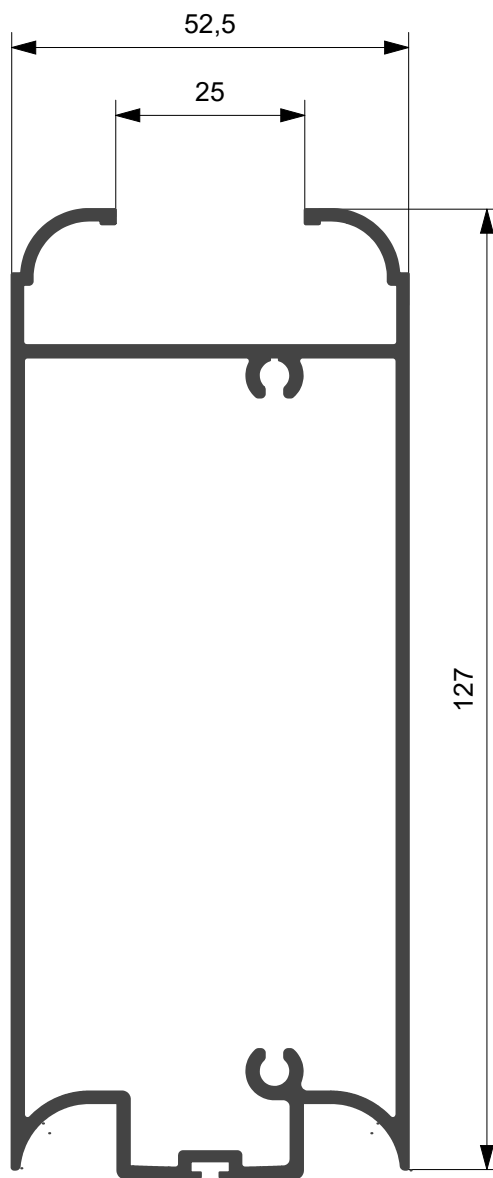

CX45.458

Kg/ml 1.820

--- mm. 274,0

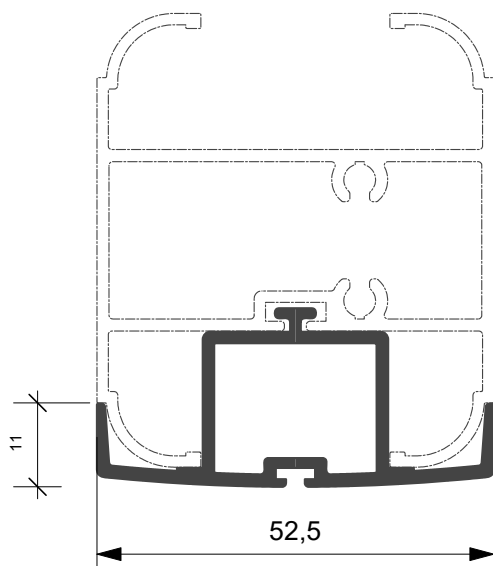

CX45.652

Kg/ml 0.562

--- mm. 21,0

Profilato	Squadretta esterna		Squadretta interna			Squadretta allineamento	
	Cianfrinare	Spinare	Bottone	Cianfrinare	Spinare	Esterna	Interna



Linea elite

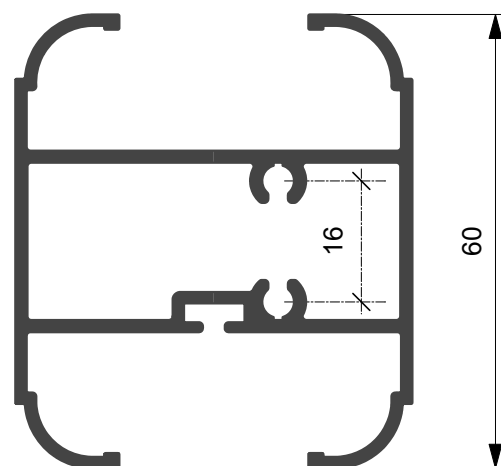
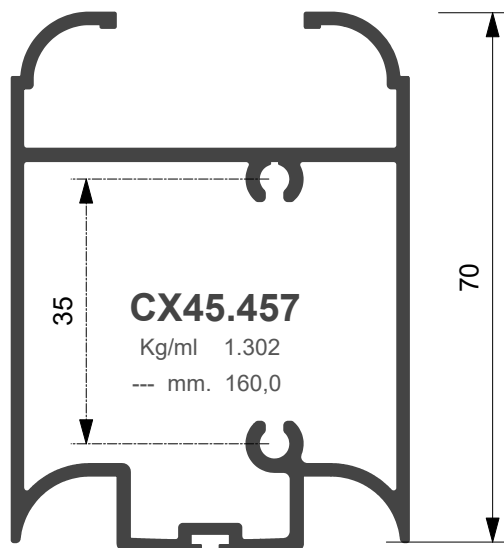
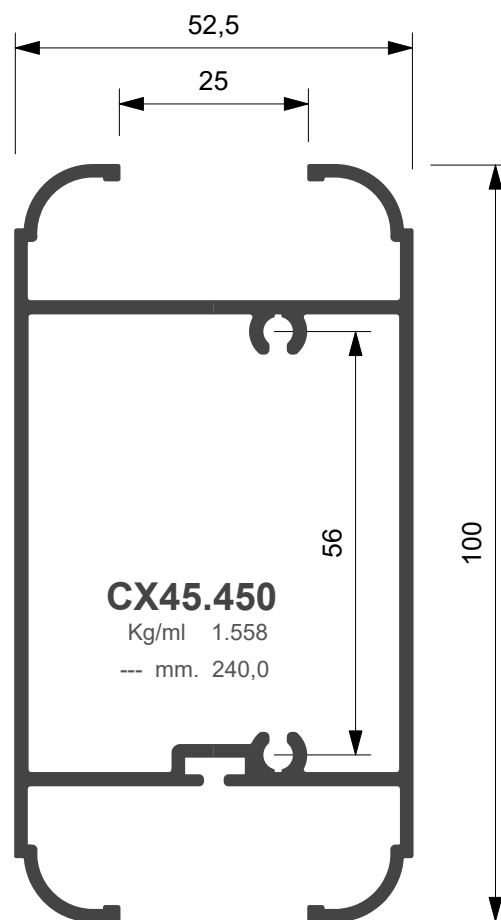
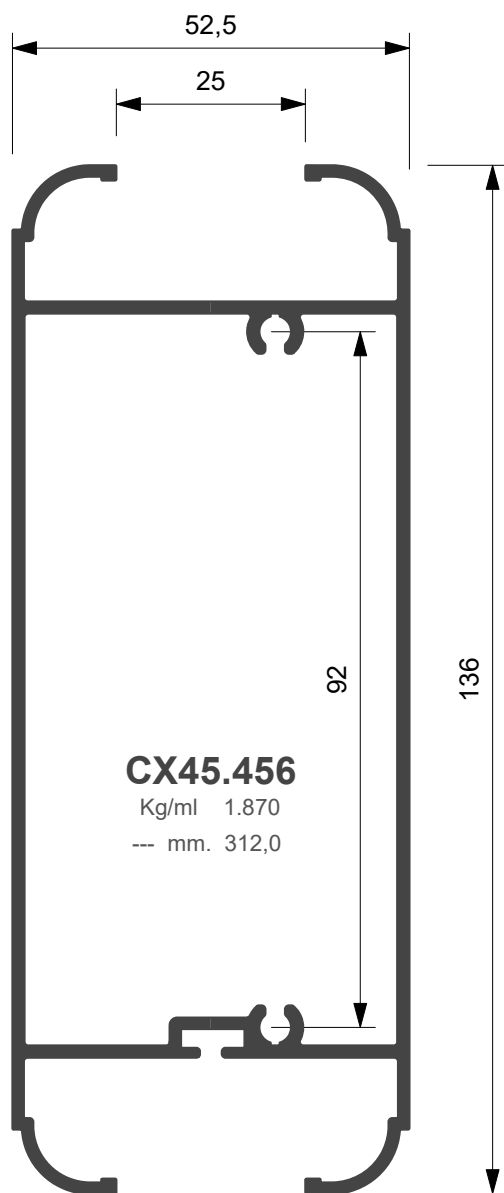

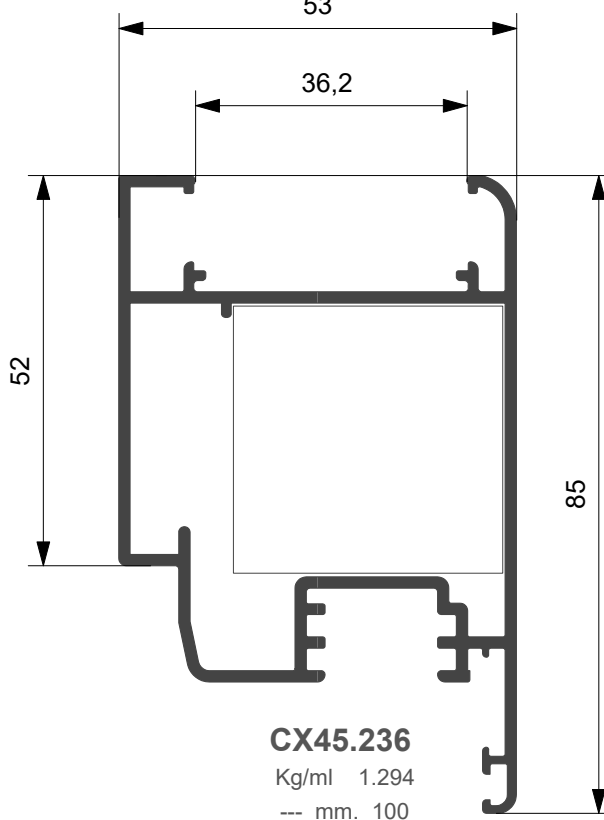
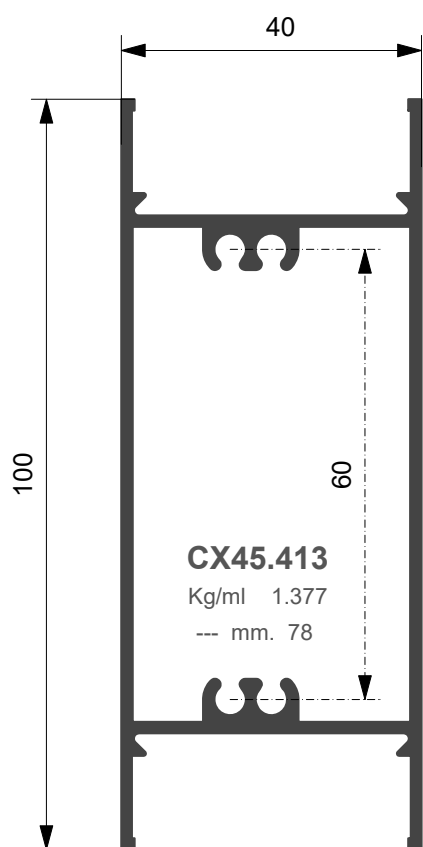
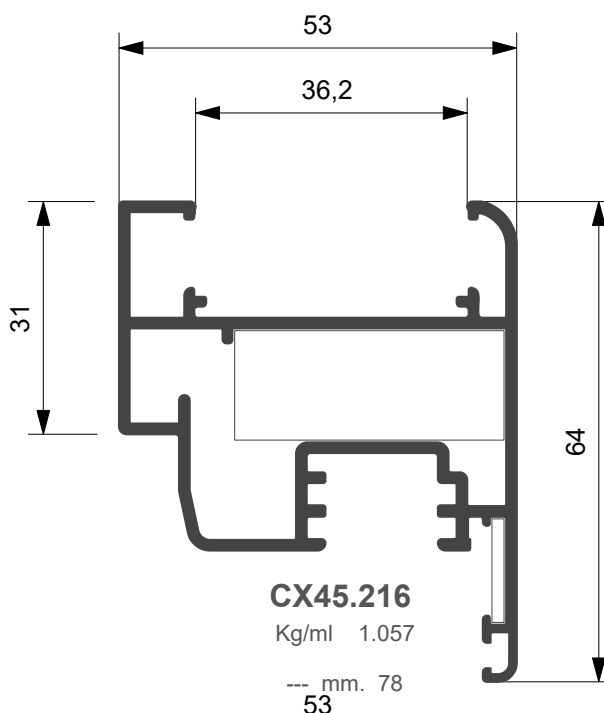
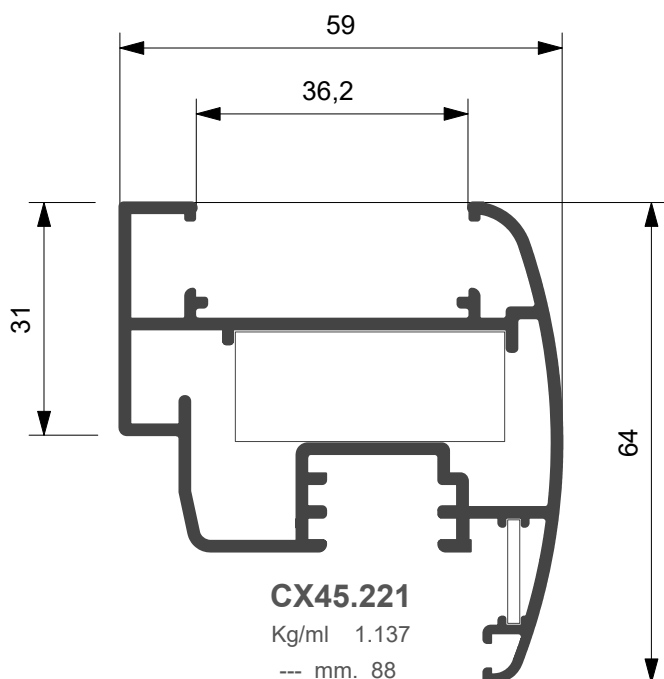

Profilato	Squadretta esterna		Squadretta interna			Squadretta allineamento	
	Cianfrinare	Spinare	Bottone	Cianfrinare	Spinare	Esterna	Interna
CX45.216			ACX.21.SQ				ARX.10.SQ
CX45.221			ACX.21.SQ				ARX.10.SQ
CX45.236			ACX.22.SQ				ARX.10.SQ



Linea Persiana
LUXOR 36.2 mm.

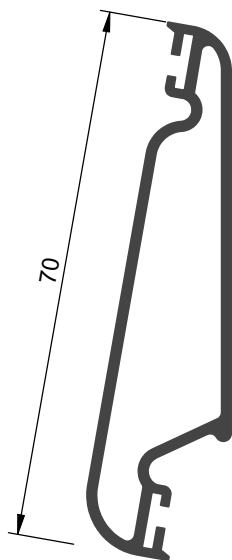

CX45.622
Kg/ml 0.530
--- mm. 160

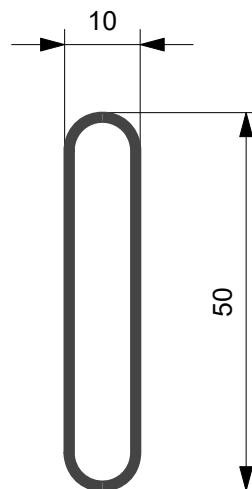

CX45.620
Kg/ml 0.364
--- mm. 111

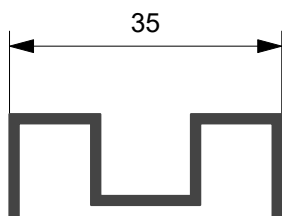

CX45.621
Kg/ml 0.308
--- mm. 24



CX45.624
Kg/ml 0.270
--- mm. 36

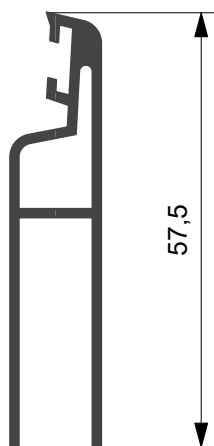

CX45.623
Kg/ml 0.448
--- mm. 104

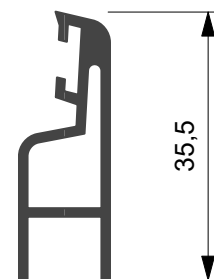

CX45.625
Kg/ml 0.313
--- mm. 60



Linea
Kosmica

CX45.4645

Kg/ml 0.524
--- mm. 166,0

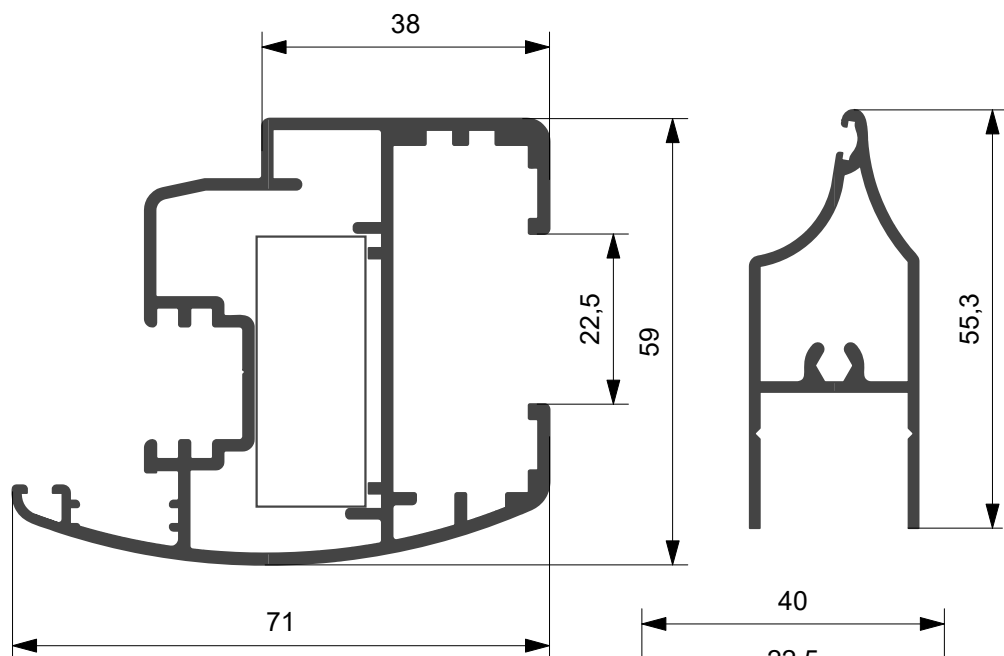

CX45.229

Kg/ml 1.365
--- mm. 139,0

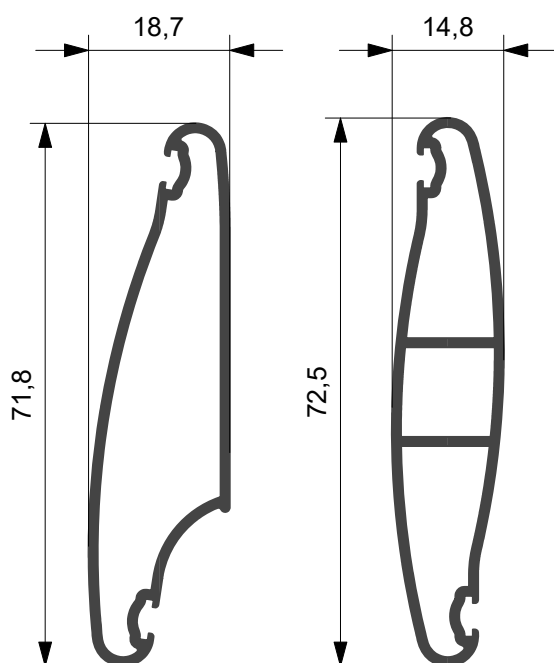

CX45.5986

Kg/ml 0.532
--- mm. 174,0

CX45.4641

Kg/ml 0.566
--- mm. 170,0

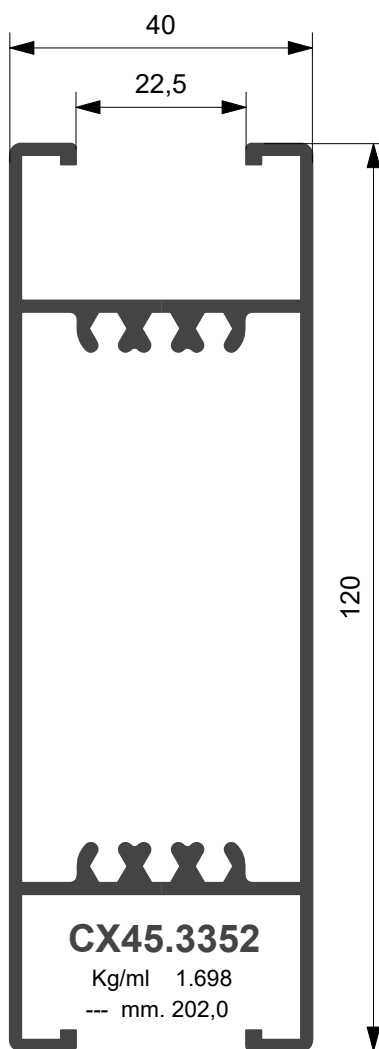

CX45.3352

Kg/ml 1.698
--- mm. 202,0

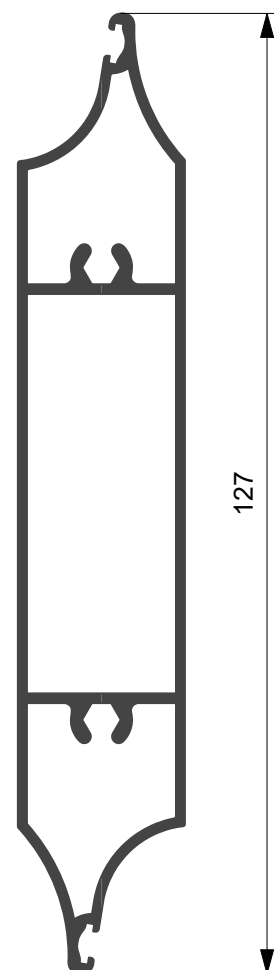

CX45.4103

Kg/ml 1.107
--- mm. 287,0

Profilato	Squadretta esterna		Squadretta interna			Squadretta allineamento	
	Cianfrinare	Spinare	Bottone	Cianfrinare	Spinare	Esterna	Interna
CX45.229			ACX.21.SQ				ARX.10.SQ

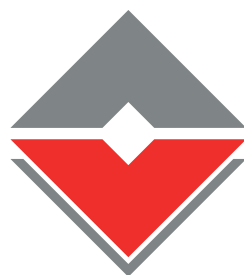

**TWIN
SYSTEMS**

ARCHITETTURE IN ALLUMINIO



Accessori e Guarnizioni
Accessories and Gaskets

Gruppo C

Elenco accessori | *Accessories List*
Elenco guarnizioni | *Gaskets List*
Serranda Avvolgibile | *Roller Shutter*



Squadrette

ACX.01.SQ	
Descrizione Squadretta a pulsante (28.5 mm x 14.5 mm)	
Materiale Zama	

ARX.10.SQ	
Descrizione Squadretta allineamento interna	
Materiale Nylon	

ARX.11.SQ	
Descrizione Squadretta allineamento interna per profili CX40.109 e XX70.801	
Materiale Zama	

ACX.12.SQ	
Cavallotto (28.5 mm x 14.5 mm)	
Zama	

ARX.15.SQ	
Descrizione Squadretta allineamento est Fuji	
Materiale Zama	

ACX.21.SQ	
Descrizione Squadretta a pulsante (35.7 mm x 14.5 mm)	
Materiale Zama	

ACX.22.SQ	
Descrizione Squadretta a pulsante (35.7 mm x 35.9 mm)	
Materiale Zama	

ACX.23.SQ	
Descrizione Squadretta angolo variabile (35.8 mm x 14. mm)	
Materiale Acciaio	

Squadrette

ARX.24.SQ	
Descrizione Squadretta allineamento esterna	
Materiale Nylon	

AWX.19.SQ	
Descrizione Squad. avvitare / cianf./ spinare (17,5 mm x 15mm)	
Materiale Alluminio	

Cerniere

ACX.02.01	
Descrizione Cerniera a montaggio rapido preassemblata a 2 ali	
Materiale Alluminio - Acciaio inox	

ACX.02.02	
Descrizione Cerniera a montaggio rapido preassemblata a 2 ali per 3°anta	
Materiale Alluminio - Acciaio inox	

ACX.02.03	
Descrizione Cerniera a montaggio rapido preassemblata a 3 ali	
Materiale Alluminio - Acciaio inox	

ACX.02.04	
Descrizione Cerniera a montaggio rapido preassemblata a 3 ali per 3°anta	
Materiale Alluminio - Acciaio inox	

ACX.02.05	
Descrizione Cerniera per vasistas apertura singola 30°	
Materiale Acciaio	

ACX.02.06	
Descrizione Cerniera per vasistas apertura doppia 30°/75°	
Materiale Acciaio	

ACX.02.07	
Descrizione Braccio lungo per vasistas (anta da mm. 600 a mm. 1600)	
Materiale Acciaio	

ACX.02.08	
Descrizione Braccio corto per vasistas (anta da mm. 280 a mm. 800)	
Materiale Acciaio	

Cerniere

ACX.02.09	
Descrizione Braccio telescopico per vasistas a scatto	
Materiale Acciaio	

ACX.02.10	
Descrizione Cerniera a compasso	
Materiale Acciaio	

ACX.02.11	
Descrizione Cerniera per porte con piastrina ad infilare	
Materiale Alluminio-Acciaio inox	

ACX.02.12	
Descrizione Cerniera per porte esterna a 2 ali interasse 60 mm.	
Materiale Alluminio-Acciaio inox	

ACX.02.13	
Descrizione Cerniera per porte esterna a 3 ali interasse 60 mm.	
Materiale Alluminio-Acciaio inox	

ACX.02.14	
Descrizione Cerniera per porte esterna a 2 ali interasse 79 mm.	
Materiale Alluminio-Acciaio inox	

ACX.02.15	
Descrizione Cerniera per porte esterna a 3 ali interasse 79 mm.	
Materiale Alluminio-Acciaio inox	

ACX.02.16	
Descrizione Spessore mm.8 per cerniere esterne per porte	
Materiale Alluminio-Acciaio inox	



Cerniere

ACX.02.17	
Descrizione Cerniera per scuretto	
Materiale Alluminio-Acciaio inox	

Chiusure

ACX.03.07	
Descrizione Cremonese con chiave Interasse 84 - 92 - 104	
Materiale Zama	

Chiusure

ACX.03.01	
Descrizione Cricchetto in alluminio fissaggio con piastrine	
Materiale Zama - Acciaio	

ACX.03.08	
Descrizione Cremonese per Anta Ribalta	
Materiale Zama	

ACX.03.09	
Descrizione Movimentazione Bidirezionale	
Materiale Zama	

ACX.03.02	
Descrizione Maniglia a tavellino	
Materiale Zama	

ACX.03.10	
Descrizione Movimentazione Unidirezionale per Anta Ribalta	
Materiale Zama	

ACX.03.03	
Descrizione Maniglia doppia	
Materiale Zama	

ACX.03.11	
Descrizione Catenacciolo a leva	
Materiale Zama	

ACX.03.04	
Descrizione Martellina	
Materiale Zama	

ACX.03.12	
Descrizione Terminale asta	
Materiale Zama	

ACX.03.05	
Descrizione Martellina con chiave	
Materiale Zama	

ACX.03.13	
Descrizione Incontro asta singolo	
Materiale Zama	

ACX.03.06	
Descrizione Cremonese Interasse 84 - 92 - 104	
Materiale Zama	

ACX.03.14	
Descrizione Incontro asta doppio	
Materiale Zama	



Chiusure

ACX.03.15	
Descrizione	
Ferma anta	
Materiale	
Zama	

ACX.03.16	
Descrizione	
Perno di chiusura supplementare regolabile	
Materiale	
Zama	

ACX.03.17	
Descrizione	
Innesti cremonese	
Materiale	
Nylon	

ACX.03.18	
Descrizione	
Terminali astina	
Materiale	
Nylon	

ACX.03.19	
Descrizione	
Sostegno anta	
Materiale	
Nylon	

Tappi

ARX.04.02	
Descrizione	
Tappo riporto G. A. ferr. nastro Profilo riporto tondo CX45.302	
Materiale	
EPDM e NYLON	

ARX.04.04	
Descrizione	
Tappo riporto G. A. ferr. nastro Profilo riporto dritto CX45.302	
Materiale	
EPDM e NYLON	

Tappi

ACX.04.05	
Descrizione	
Tappo riporto Giunto Aperto Profilo riporto tondo CX45.301	
Materiale	
EPDM e NYLON	

ACX.04.06	
Descrizione	
Tappo riporto Giunto Aperto Profilo riporto dritto CX45.304	
Materiale	
EPDM e NYLON	

ACX.04.07	
Descrizione	
Tappo riporto Doppia Battuta Profili CX45.301 - 304	
Materiale	
NYLON	

ACX.04.10	
Descrizione	
Tappo riporto Giunto aperto Profili CX45.301 - 304	
Materiale	
NYLON	

ACX.04.11	
Descrizione	
Tappo riporto Doppia Battuta Profili CX45.301 - 304	
Materiale	
NYLON	

ACX.04.12	
Descrizione	
Tappo riporto Doppia Battuta e Giunto Aperto ELITE CX45.351	
Materiale	
NYLON	

ACX.04.13	
Descrizione	
Tappo chiudi-tubolarità Profili riporto CX45.301 - 304	
Materiale	
NYLON	

ACX.04.14	
Descrizione	
Tappo chiudi-tubolarità Profili anta CX45.208 - 213	
Materiale	
NYLON	



Tappi

ACX.04.15	
Descrizione Tappo chiudi-tubolarità Profilo riporto CX45.351 Elite	
Materiale Nylon	

ACX.04.16	
Descrizione Tappo chiudi-tubolarità Anta persiana CX45.259 Elite	
Materiale Nylon	

ACX.04.17	
Descrizione Tappo chiudi-tubolarità Anta persiana CX45.250 Elite	
Materiale Nylon	

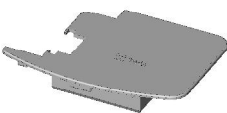
ACX.04.18	
Descrizione Tappo chiudi-tubolarità Anta persiana CX45.218	
Materiale Nylon	

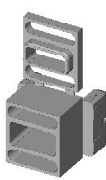
ACX.04.19	
Descrizione Tappo giunzione a 90° fascie infilare (25x22) e (25x22)	
Materiale Nylon	

ARX.04.30	
Descrizione Tappo a L battuta inferiore porte	
Materiale NYLON	

ARX.04.31	
Descrizione Tappo diritto battuta inf. porte	
Materiale NYLON	

Scarichi acqua

ARX.05.01	
Descrizione Cappetta drenaggio acqua	
Materiale Nylon	

Attacchi muratura

ARX.06.01	
Descrizione Registro Universale	
Materiale Nylon	

ARX.06.02	
Descrizione Piastrina Registro Universale	
Materiale Zama	

ARX.06.03	
Descrizione Grano per registro	
Materiale Alluminio	

ACX.06.04	
Descrizione Registro Z/P	
Materiale Nylon	

Accessori vetro

ARX.07.01	
Descrizione Registro vetrocamera per profili vetro ad infilare	
Materiale Nylon	

ACX.07.02	
Descrizione Angolo Universale fermavetro	
Materiale Zama	

ACX.07.08	
Descrizione Clip per fermavetri tondi	
Materiale Nylon	

Anta ribalta

ACX.08.01	
Descrizione	
<p>Anta Ribalta Kit BASE senza cremonese con anti falsa manovra sulla cremonese</p>	
Materiale	

ACX.08.09	
Descrizione	
<p>A. R. Cerniere a pettine</p>	
Materiale	

ACX.08.10	
Descrizione	
<p>A. R. Astina prelavorata per anta affiancata</p>	
Materiale	

ACX.08.02	
Descrizione	
<p>Anta Ribalta Braccio Corto</p>	
Materiale	

Anta ribalta

ACX.08.11	
Descrizione	
<p>Anta Ribalta Kit BASE senza cremonese con anti falsa manovra sulla cremonese</p> <p>Fulcro orizzontale</p>	
Materiale	

ACX.08.03	
Descrizione	
<p>Anta Ribalta Braccio Medio</p>	
Materiale	

ACX.08.04	
Descrizione	
<p>Anta Ribalta Braccio Lungo</p>	
Materiale	

ACX.08.12	
Descrizione	
<p>Chiusura Supplementare verticale</p>	
Materiale	

ACX.08.05	
Descrizione	
<p>A. R. Braccio Supplementare</p>	
Materiale	

ACX.08.13	
Descrizione	
<p>Riscontro per anta affiancata</p>	
Materiale	

ACX.08.06	
Descrizione	
<p>A. R. Rinvio Supplementare</p>	
Materiale	

ACX.08.14	
Descrizione	
<p>Paletto per anta affiancata</p>	
Materiale	

ACX.08.07	
Descrizione	
<p>A. R. Punto chiusura supplementare</p>	
Materiale	

ACX.08.15	
Descrizione	
<p>Chiusura Supplementare orizzontale</p>	
Materiale	



Attrezzature

ACX.09.01

Descrizione

Attrezzatura Pneumatica



ACX.09.03

Descrizione

KIT FRESE

Materiale





Guarnizioni

ARX.10.01	
Descrizione	
Guarnizione Centrale di Precamera	

ARX.10.02	
Descrizione	
Angolo per guarnizione centrale di Precamera art. ACX.10.01	

ACX.10.03	
Descrizione	
Guarnizione di battuta a scatto	

ACX.10.04	
Descrizione	
Guarnizione di battuta ad infilo	

ARX.10.05	
Descrizione	
Guarnizione vetro esterna per isolamento termico-acustico	

ARX.10.07	
Descrizione	
Guarnizione di battuta esterna acustica esterna mm.1	

ARX.10.08	
Descrizione	
Guarnizione di battuta per ferramenta a nastro	

ARX.10.09	
Descrizione	
Canalina isolante per ferramenta a nastro	

ARX.10.12	
Descrizione	
Guarnizione vetro interna spessore 3 - 4 mm.	

Guarnizioni

ARX.10.13	
Descrizione	
Guarnizione vetro interna spessore 5 - 6 mm.	

ARX.10.14	
Descrizione	
Guarnizione vetro interna spessore 7 - 8 mm.	

ARX.10.15	
Descrizione	
Guarnizione vetro interna spessore 9 - 10 mm.	

ARX.10.16	
Descrizione	
Guarnizione perimetrale	

ARX.10.27	
Descrizione	
Rotella infila guarnizioni	

ARX.10.28	
Descrizione	
Guarnizione vetro esterna coestrusa spessore 1.5 mm.	

ARX.10.29	
Descrizione	
Guarnizione vetro esterna coestrusa spessore 1.5 mm.	

ARX.10.30	
Descrizione	
Guarnizione vetro esterna Dutral spessore 3 mm.	

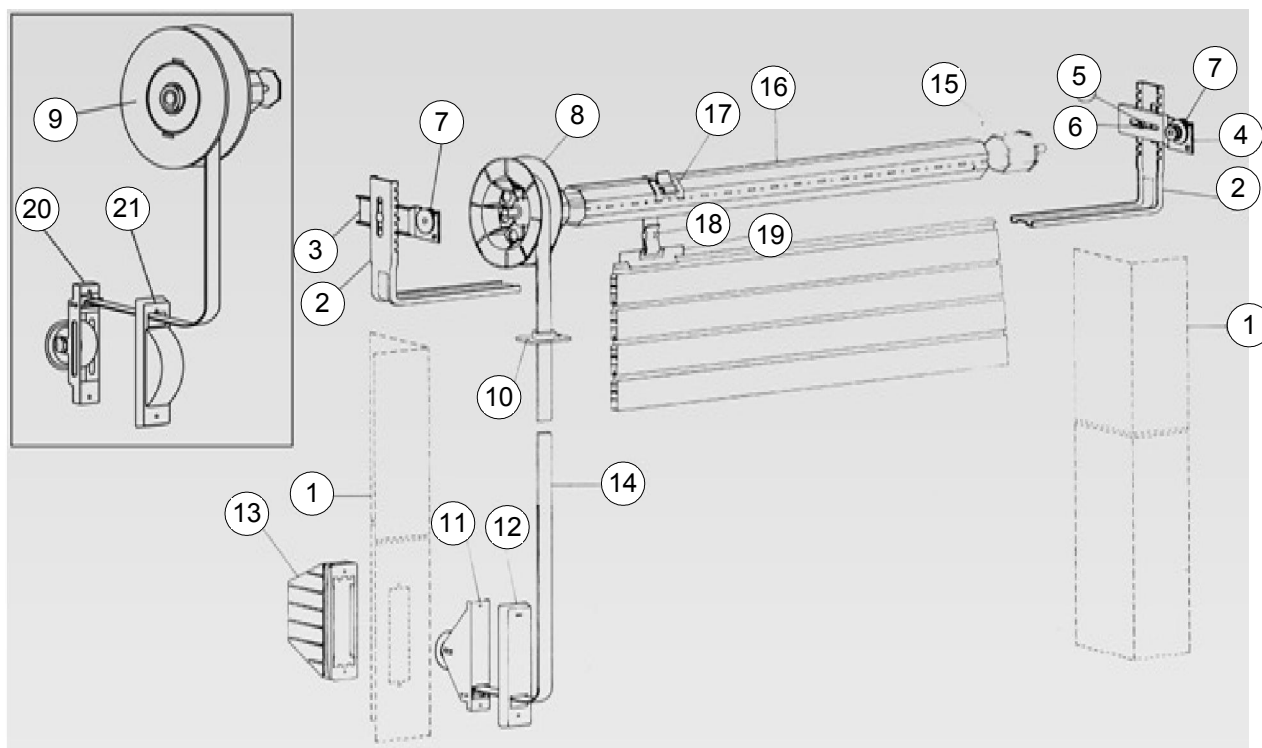

Monoblocco - Soluzione con puleggia

Codice	Descrizione	N° Pz.	Note	Rifer.
ARX.11.01	Supporto a squadra A = mm 46	2		2
ARX.11.02	Mensola per supporto (SIN)	1		3
ARX.11.03	Mensola per supporto (DX)	1		4
ARX.11.04	Vite 6 x 20 con dado	2		5 - 6
ARX.11.05	Boccola in nylon	2		7
ARX.11.06	Puleggia in plastica a minimo ingombro Ø 220	1	scegliere tipo	8
ARX.11.07	Guida cinghia trasversale in nylon	1	scegliere colore	10
ARX.11.08	Avvolgitore	1		11
ARX.11.09	Placca	1	scegliere tipo	12
ARX.11.10	Cassetta	1	scegliere tipo	13
ARX.11.11	Cintino	Mt.	scegliere tipo	14
ARX.11.12	Calotta in plastica	1		15
ARX.11.13	Rullo ottagonale	Mt.	scegliere tipo	16
ARX.11.14	Gancio per attacco cintino al rullo	2		17
ARX.11.15	Grappa fermacintino	2		18
ARX.11.16	Gancio per avvolgibili in plastica con asola	2		19

Monoblocco - Soluzione con puleggia

ARX.11.18	Riduttore portata 40 kg. R=1:2,6 Puleggia Ø 220	1		9
ARX.11.19	Avvolgitore	1		20
ARX.11.20	Placca	1	scegliere tipo	21

Vari

ARX.11.21	Invito tapparella in nylon su profilo in alluminio
ARX.11.22	Coppia tappi laterali cassonetto in alluminio



**TWIN
SYSTEMS**

ARCHITETTURE IN ALLUMINIO



Nodes
Sections

Gruppo D

Nodi principali
in scala 1:1
con relativi accessori

*Main Sections
w/Accessories
Scale 1:1*



FINESTRA A DUE ANTE
Doppia Battuta

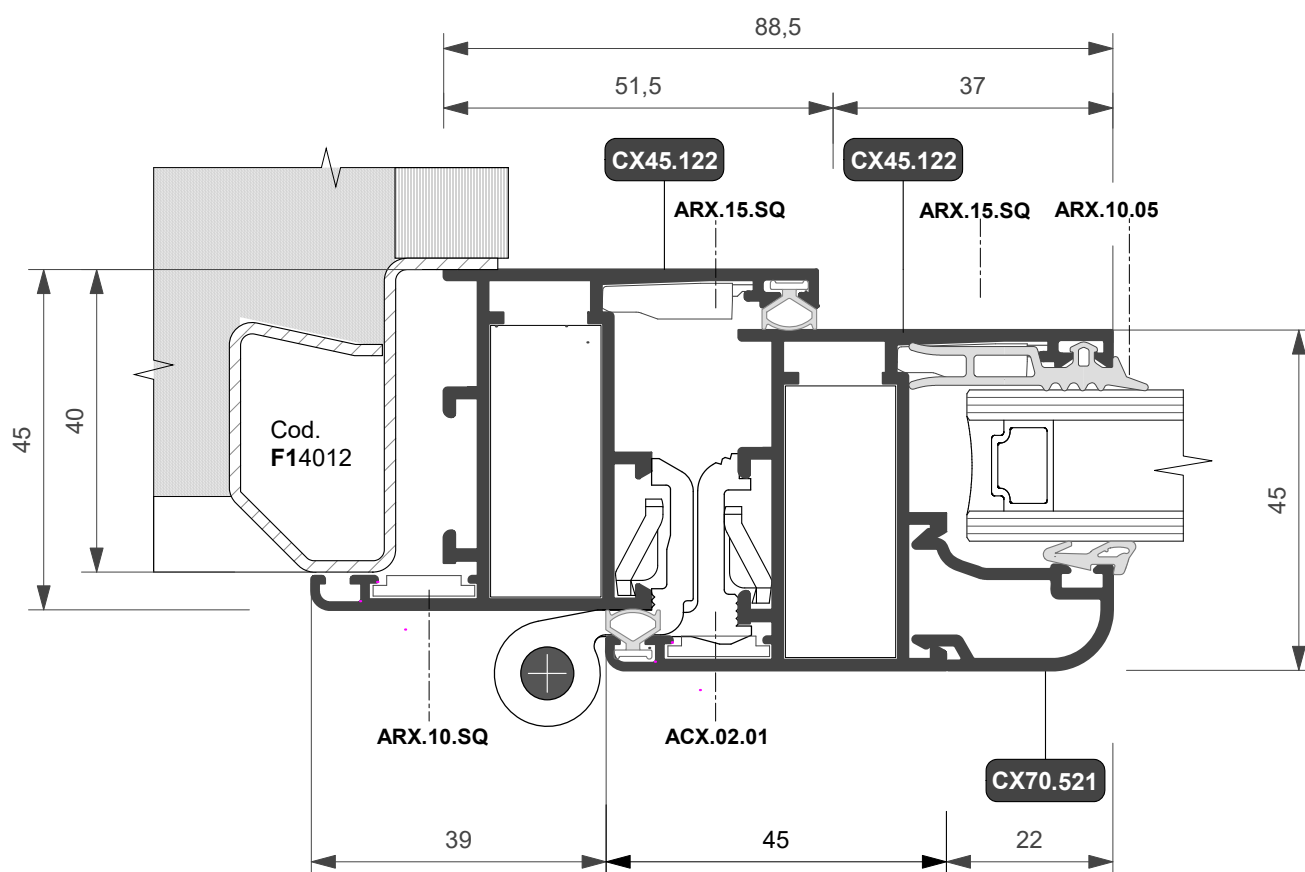
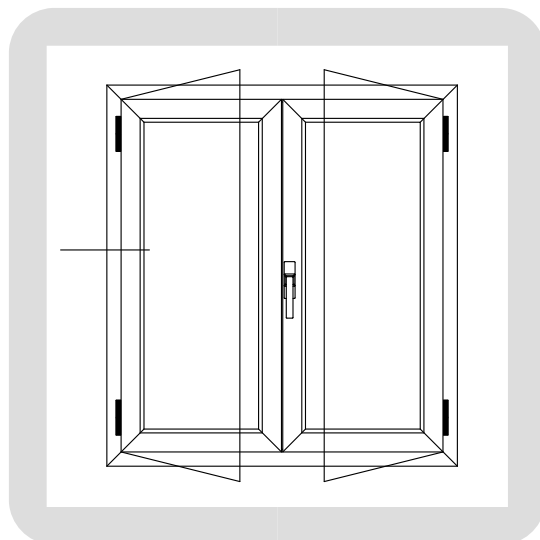



FINESTRA A DUE ANTE
Doppia Battuta

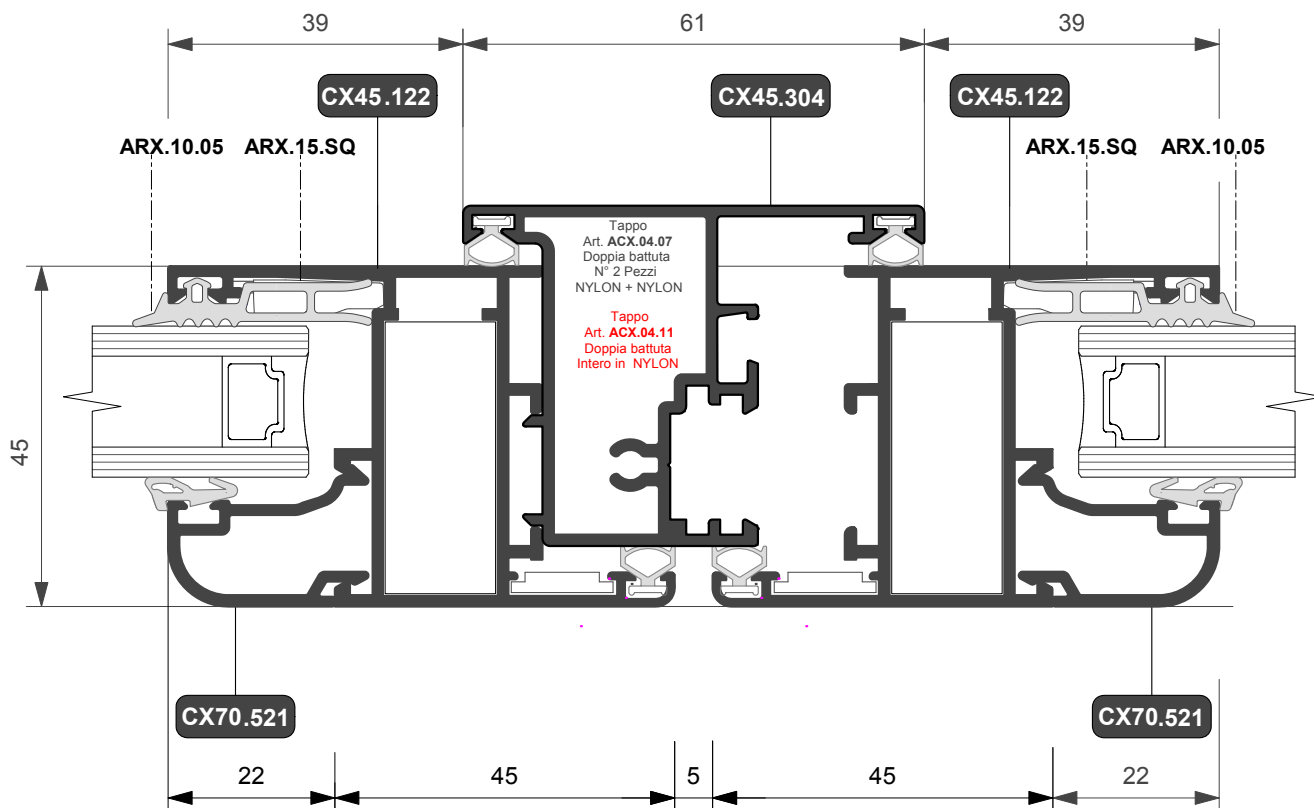
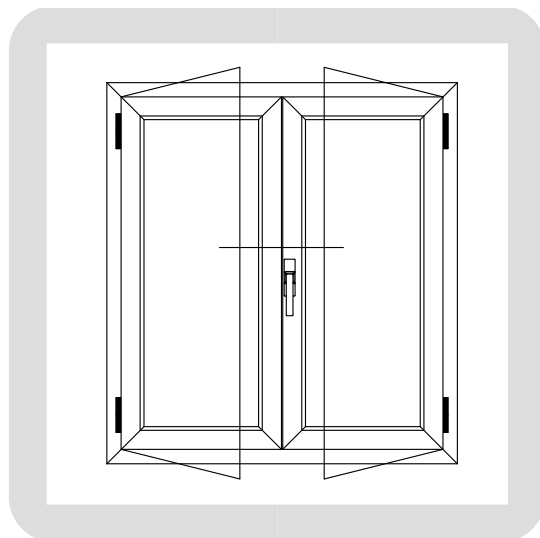



FINESTRA A DUE ANTE
Giunto aperto

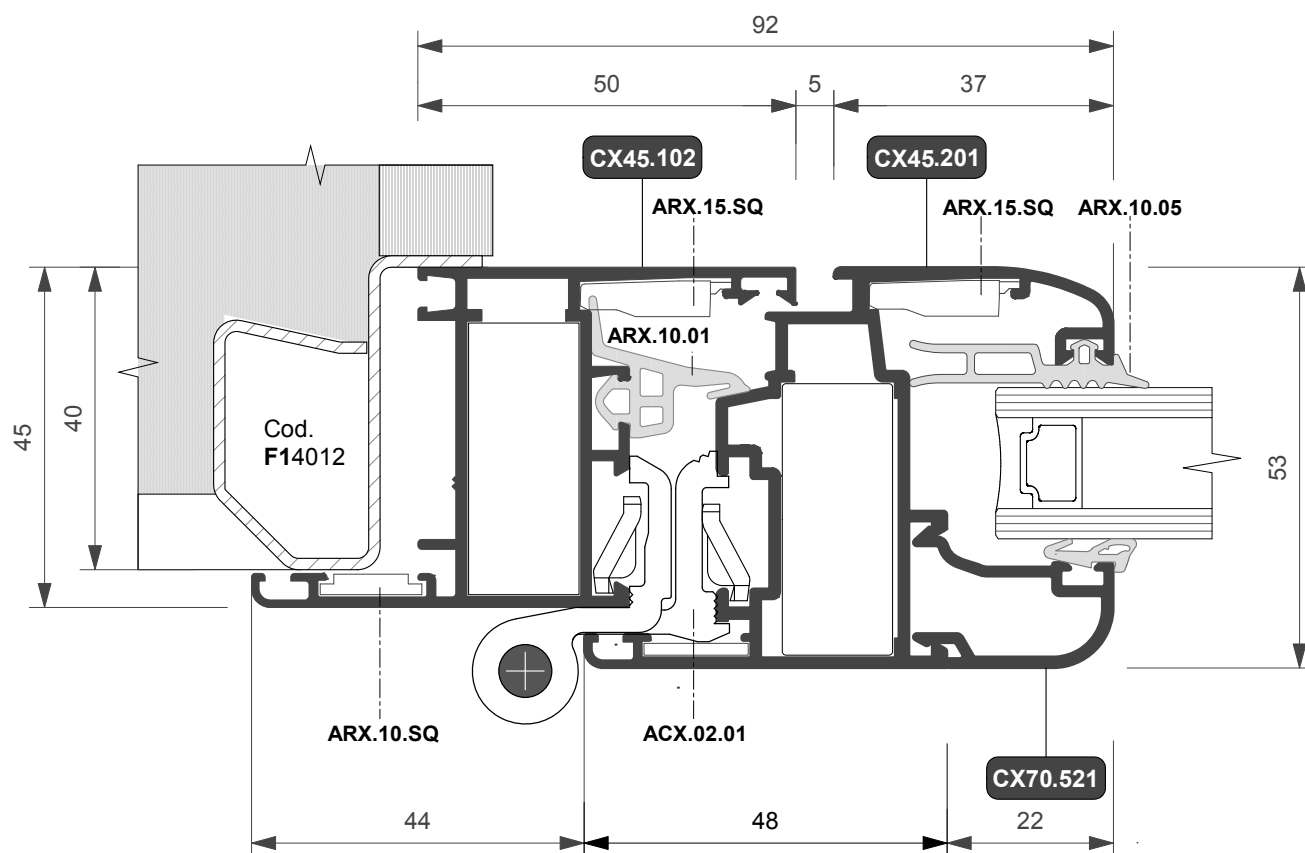
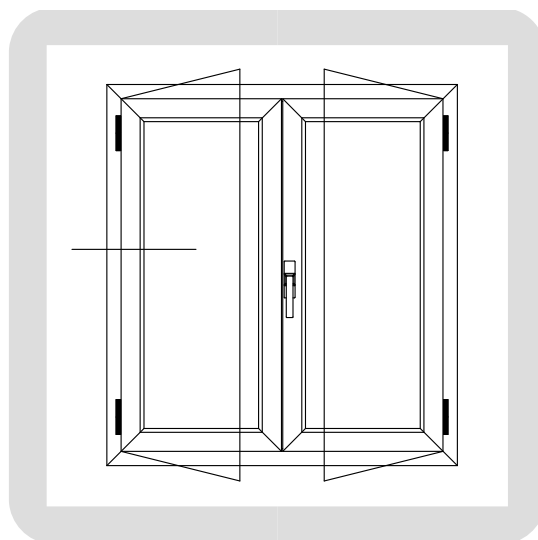



FINESTRA A DUE ANTE
Giunto aperto

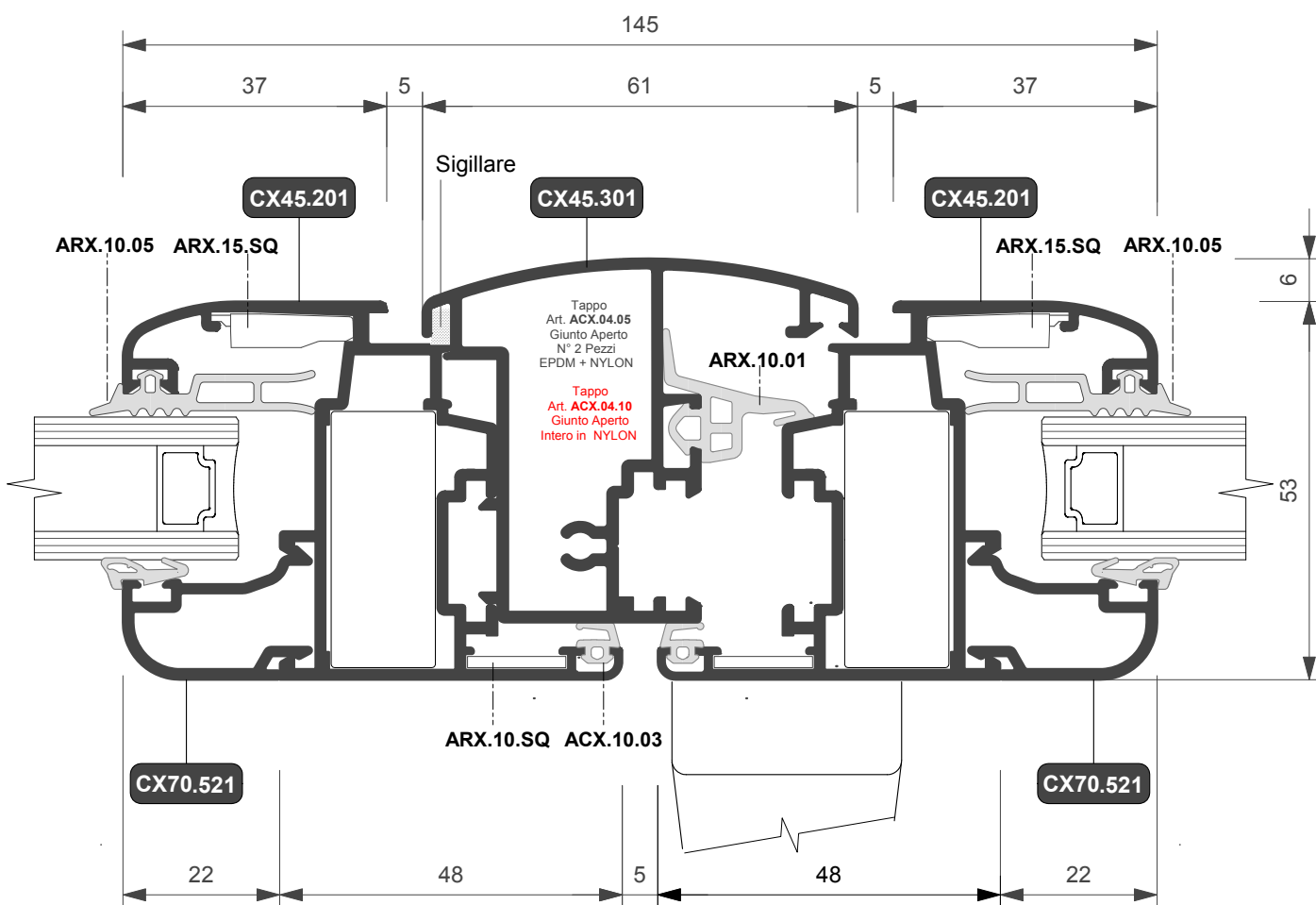
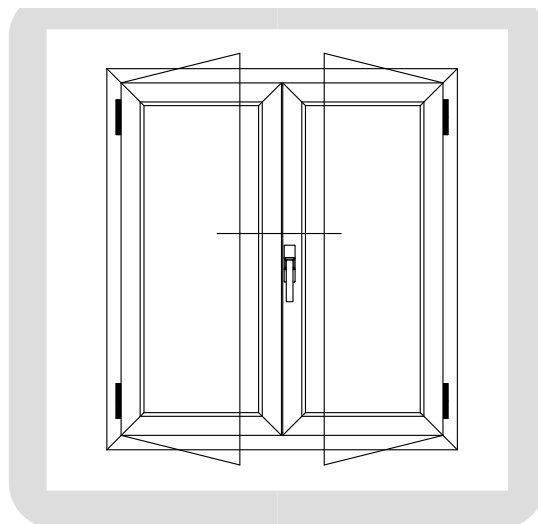



FINESTRA A DUE ANTE
Giunto aperto

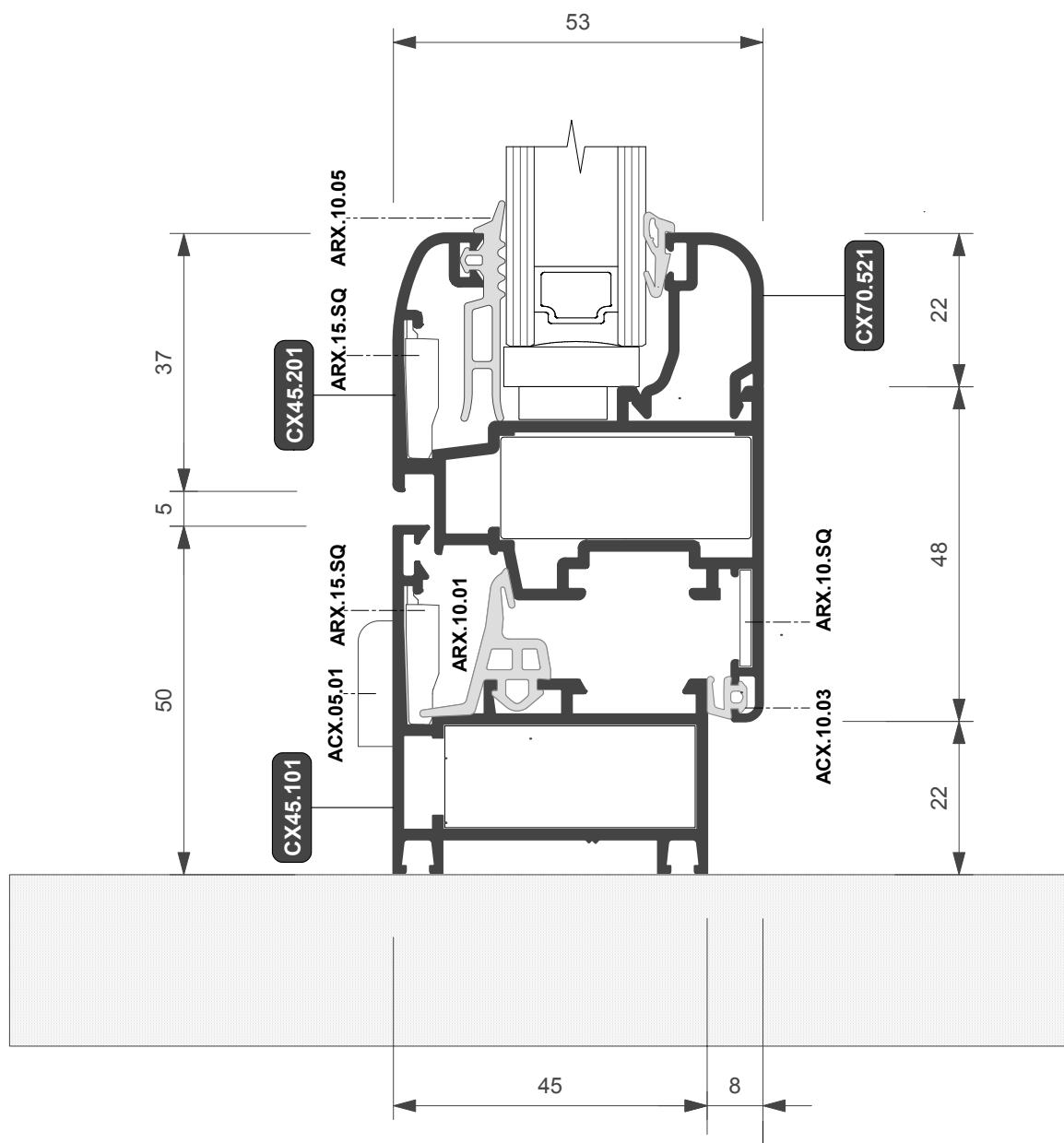
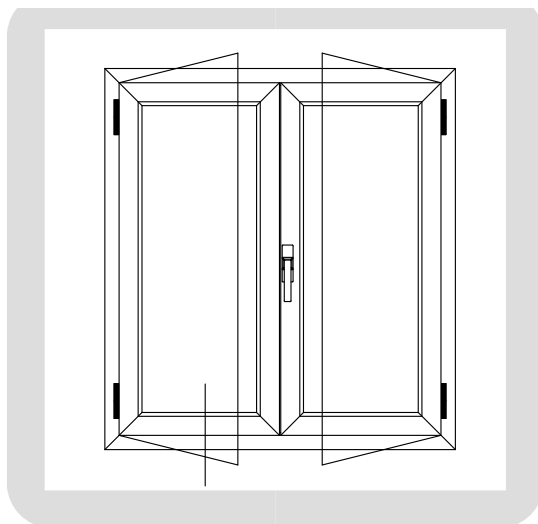



PORTA BALCONE A DUE ANTE
Giunto Aperto

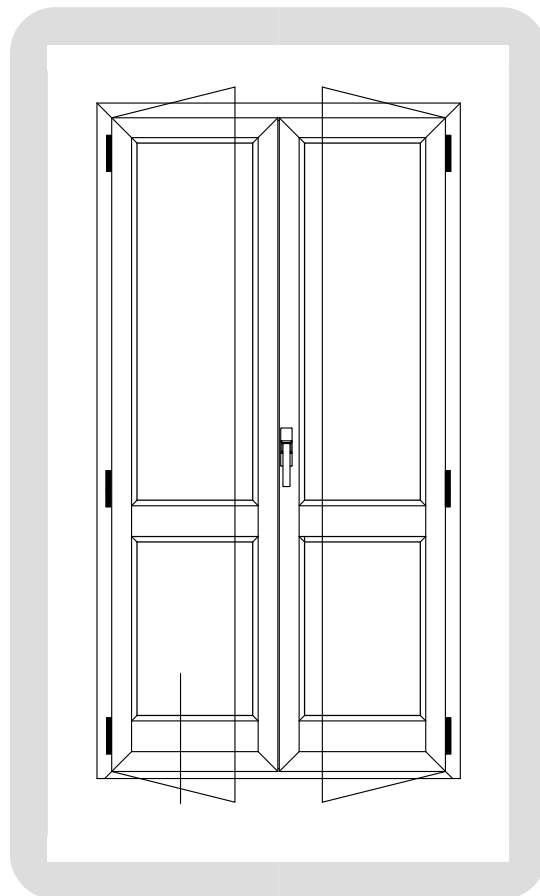
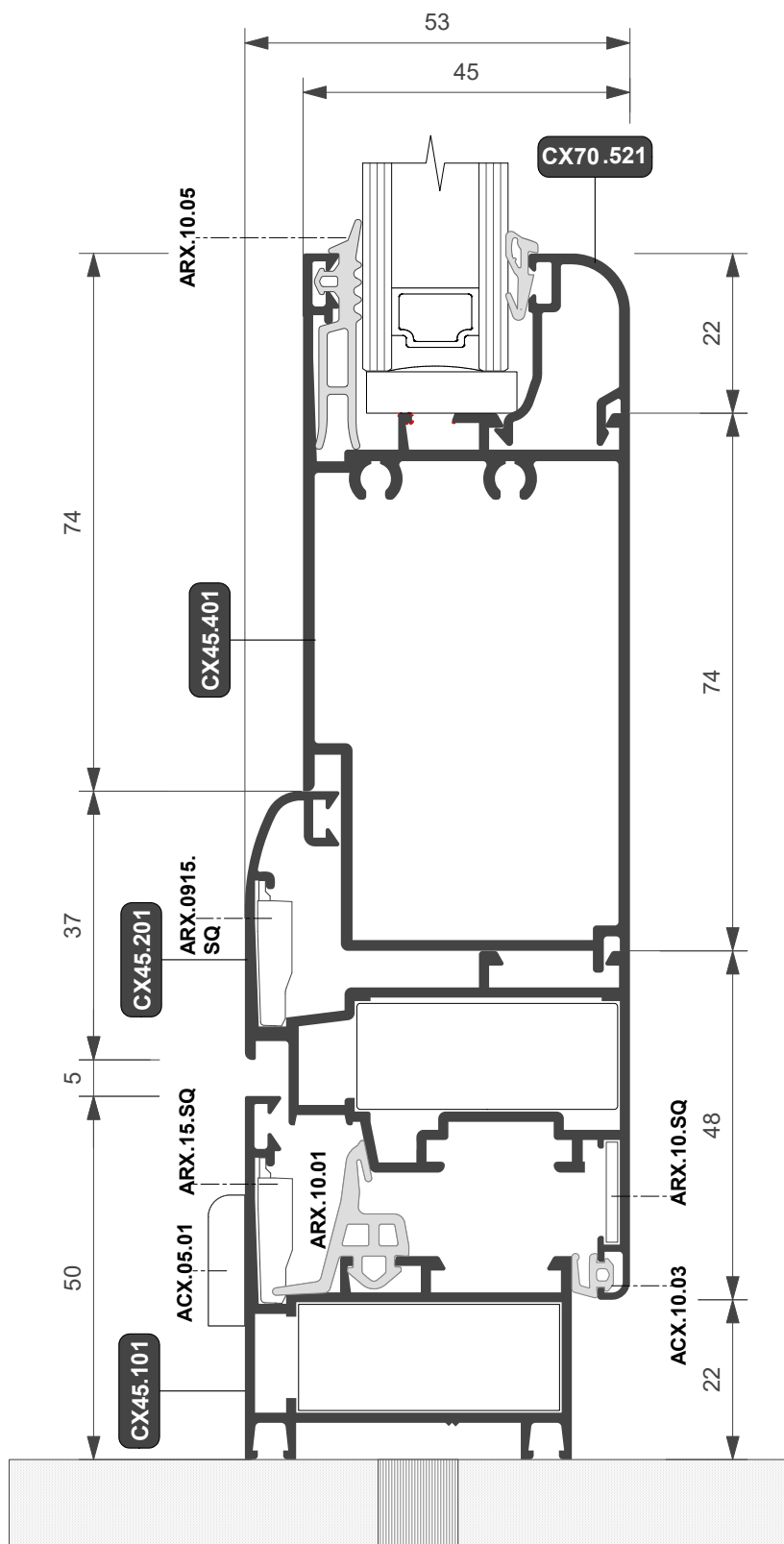



PORTA BALCONE A DUE ANTE
Giunto Aperto

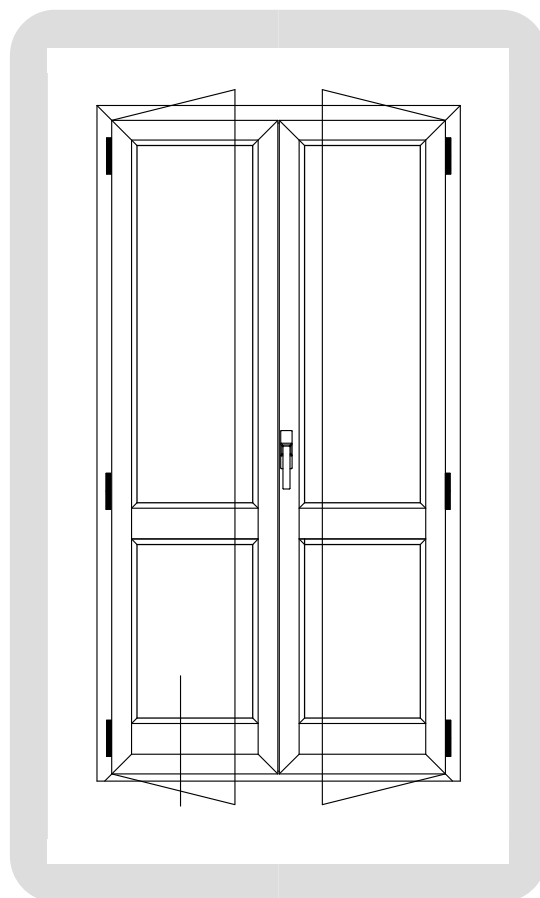
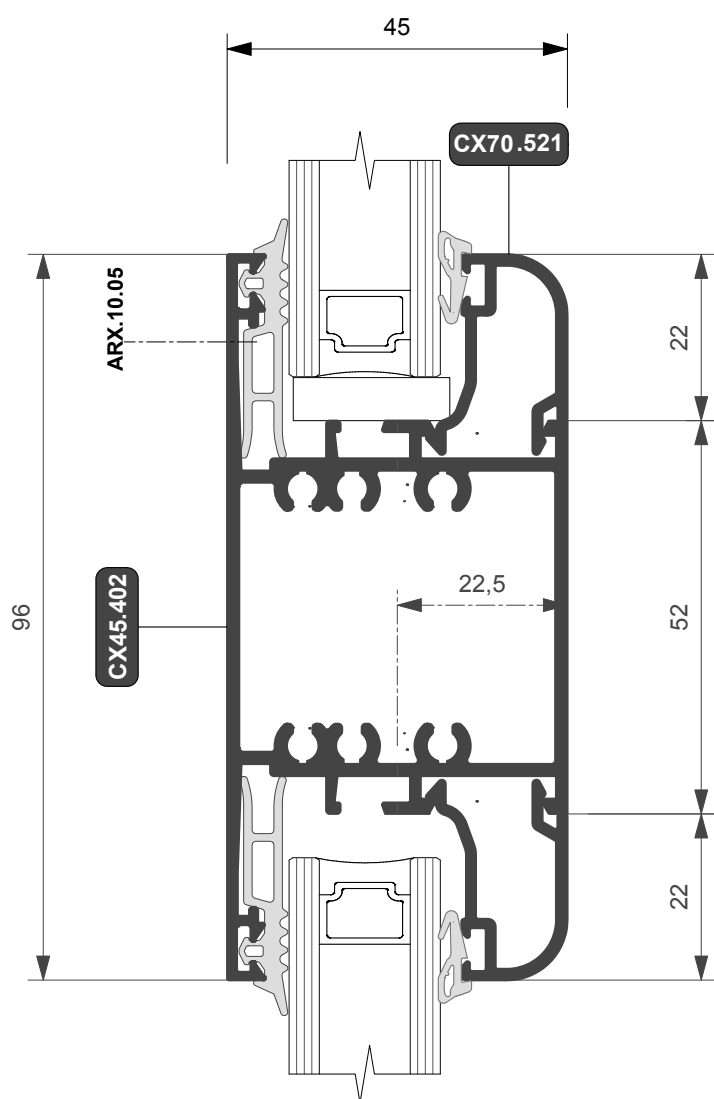



FINESTRA A DUE ANTE
Giunto aperto ad infilare

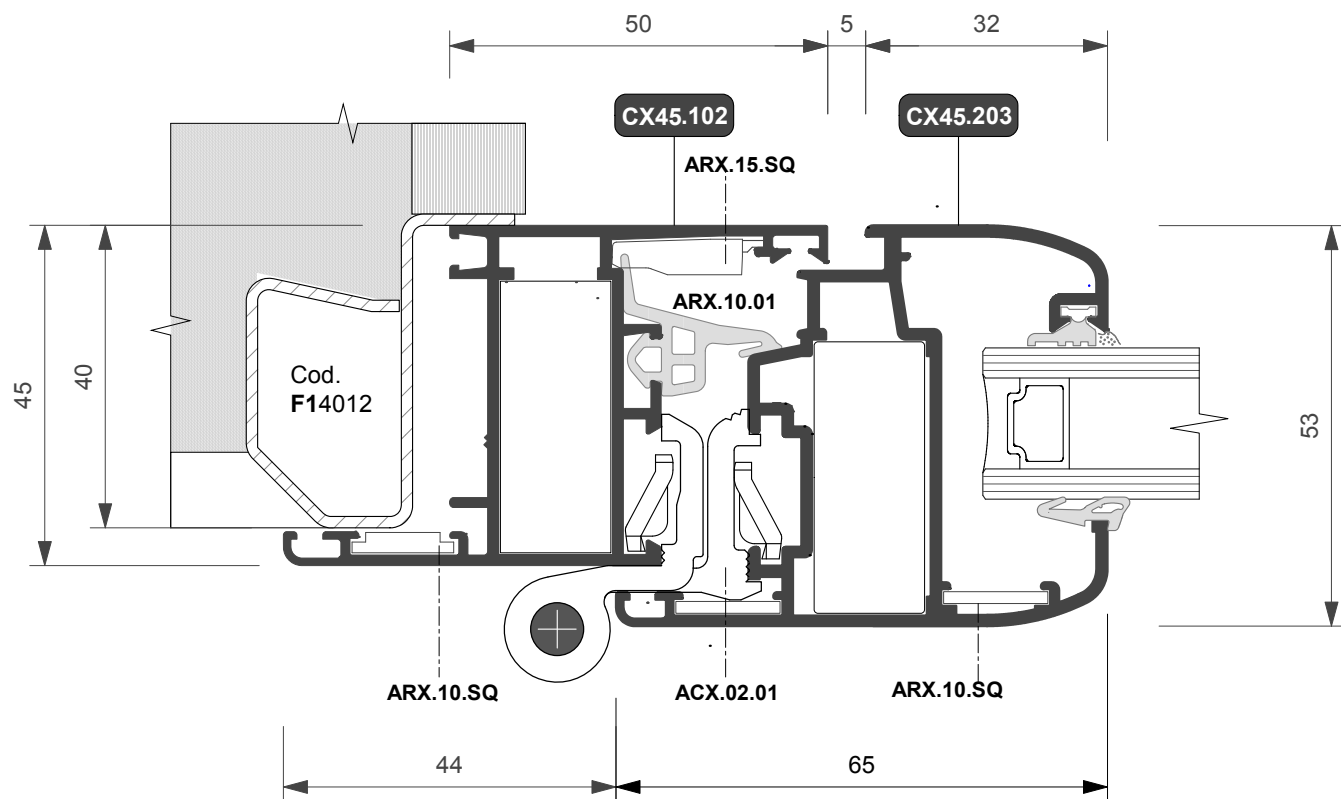
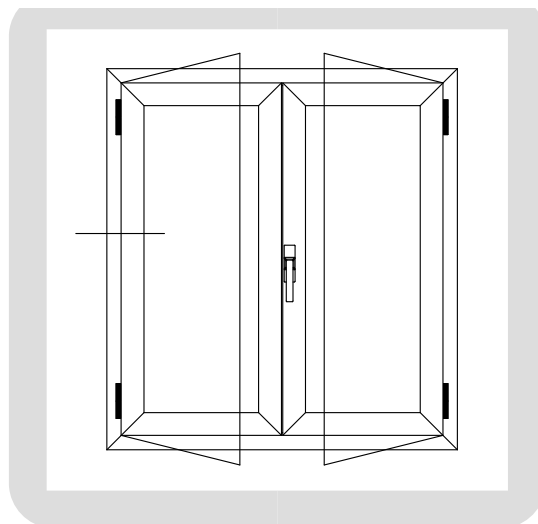



FINESTRA A DUE ANTE
Giunto aperto ad infilare

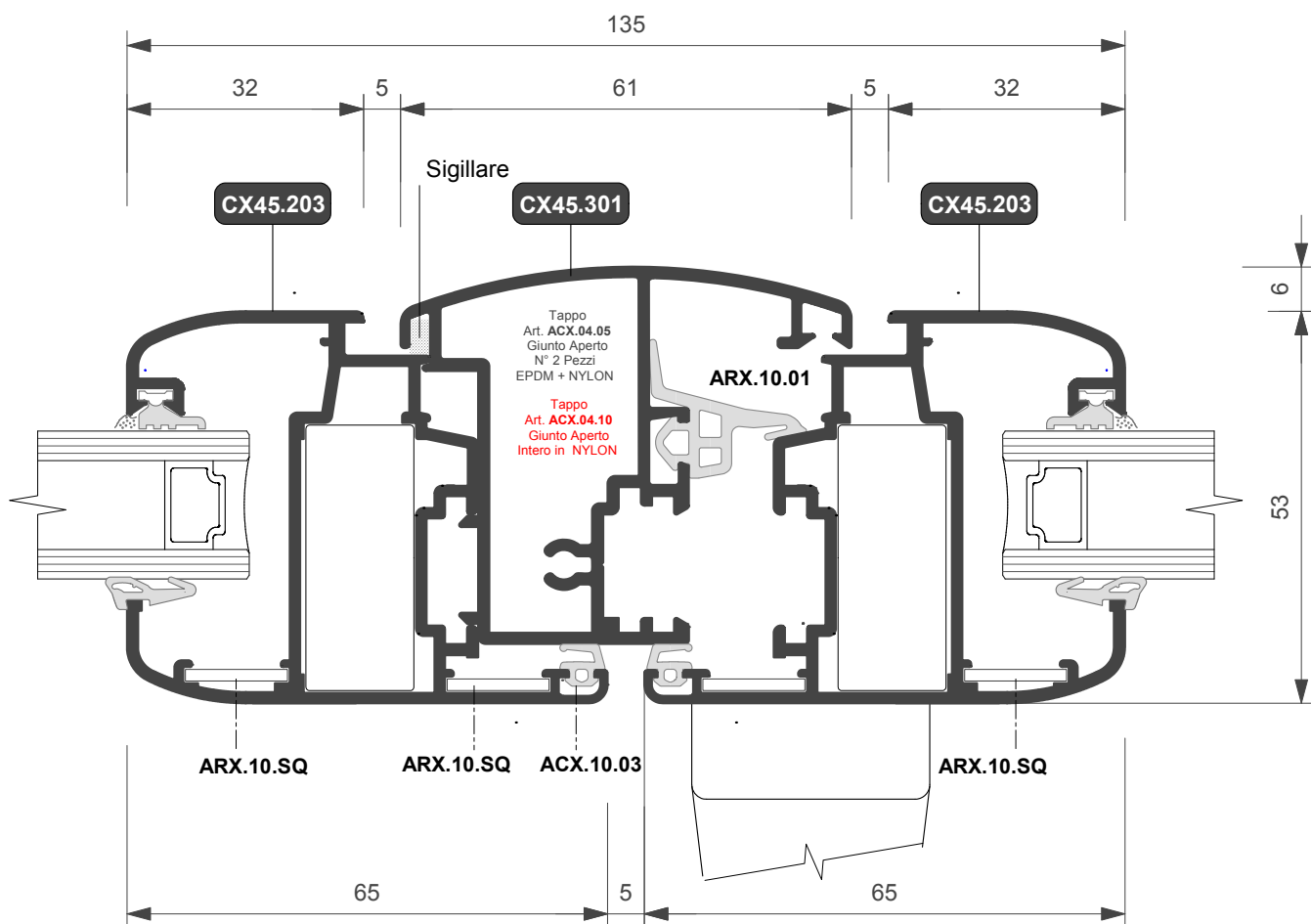
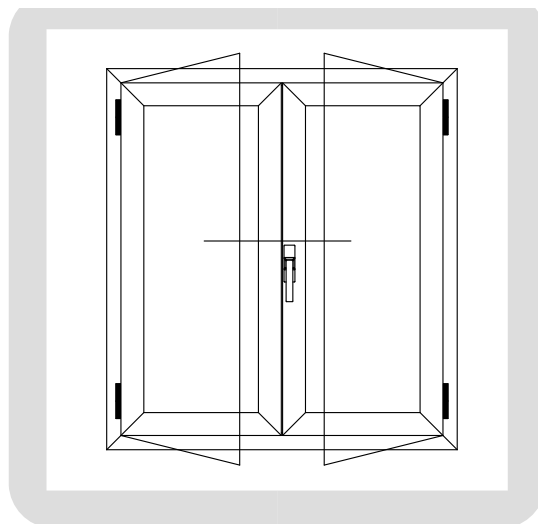



PORTA BALCONE A DUE ANTE
Giunto Aperto ad infilare

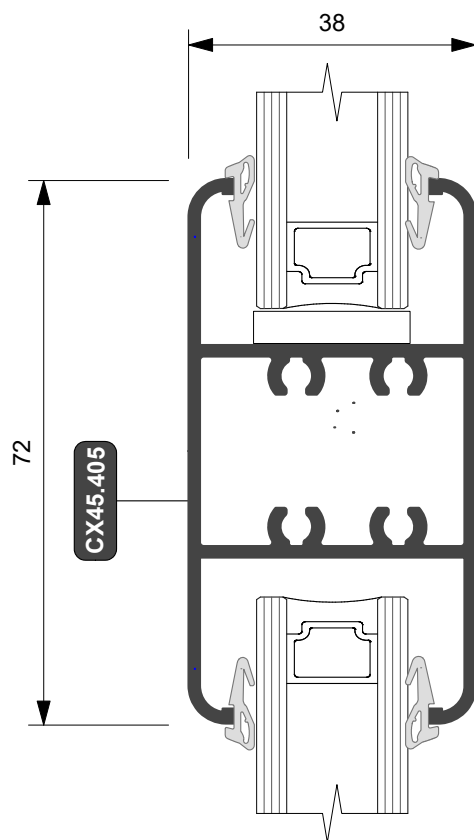
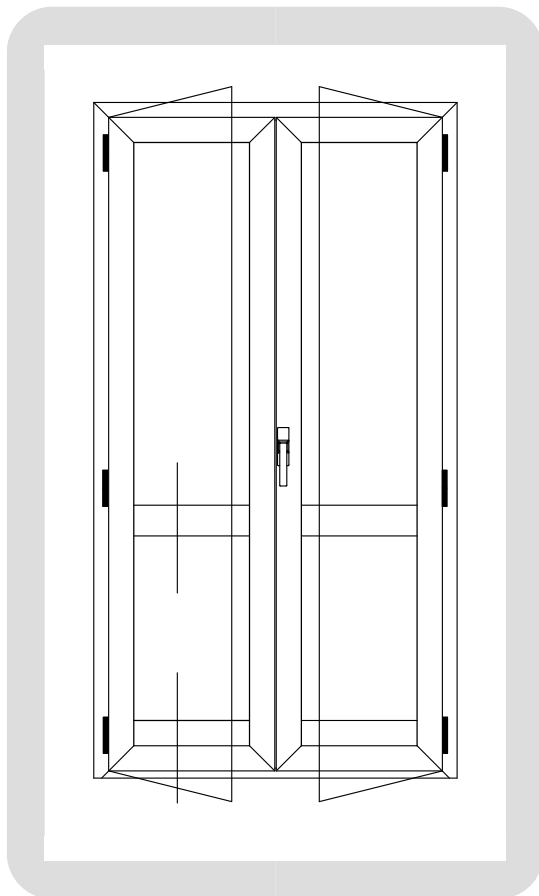
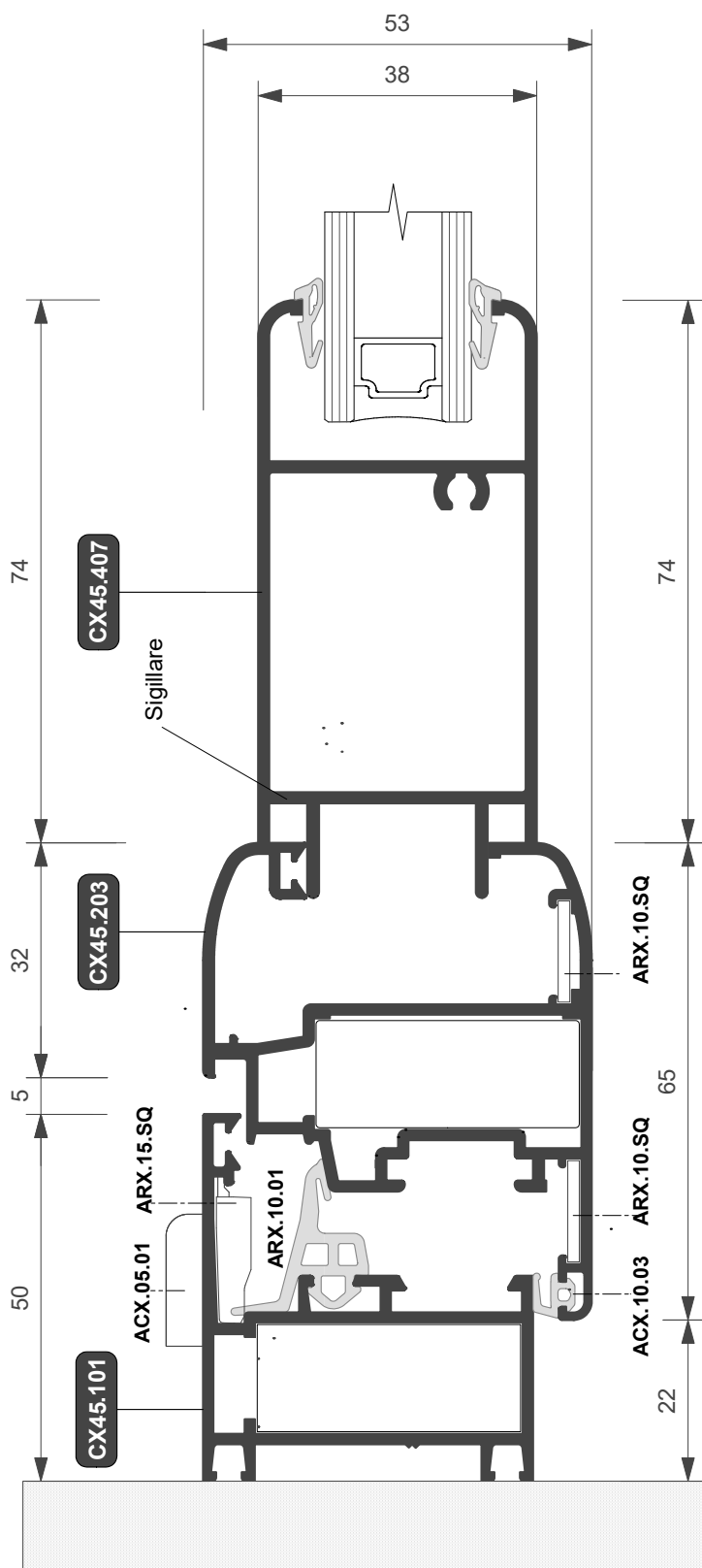



PORTA BALCONE A DUE ANTE
Giunto Aperto

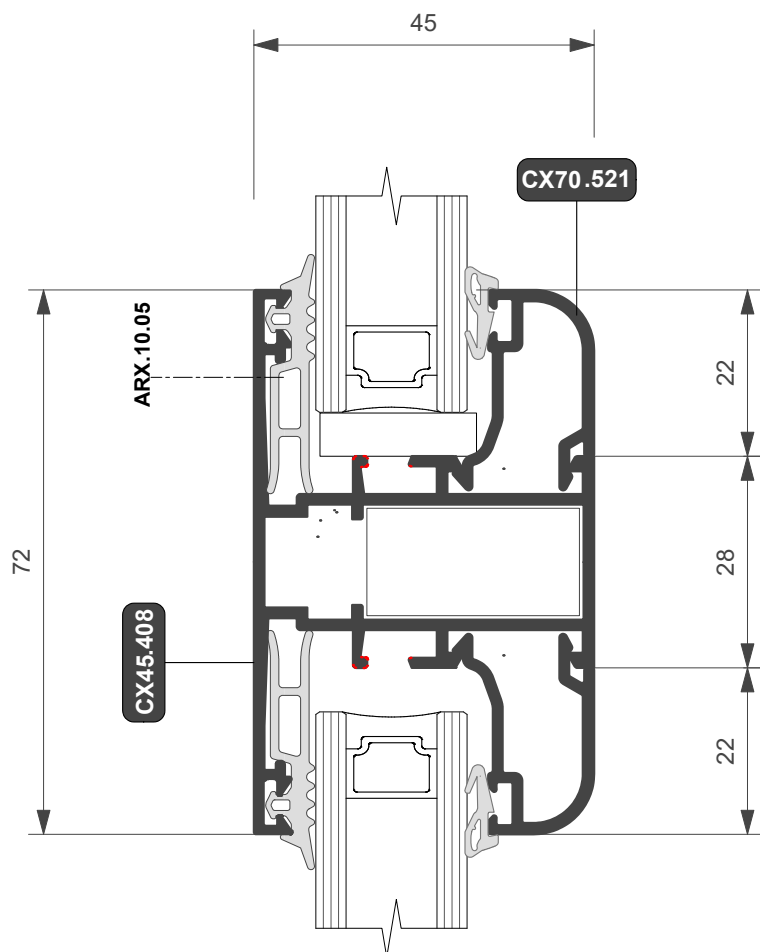
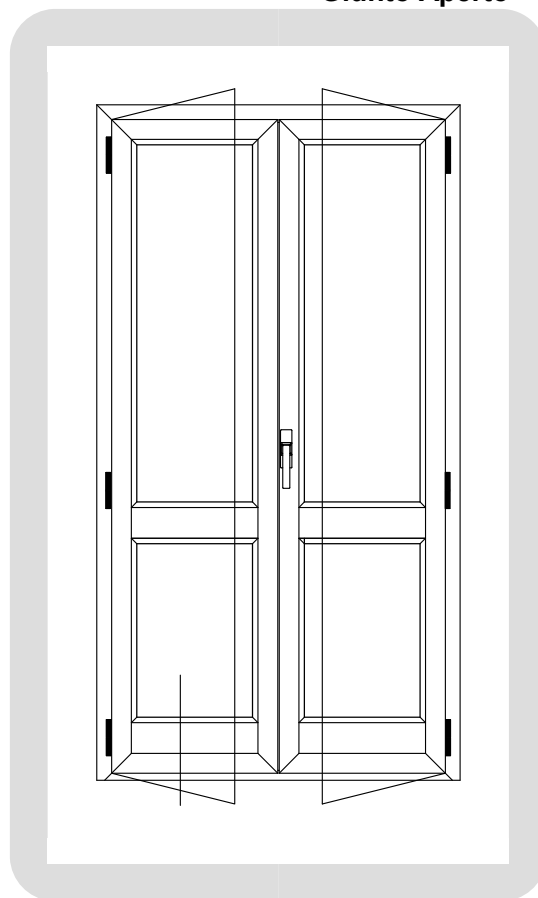



FINESTRA A DUE ANTE
Giunto aperto
Ferramenta a nastro

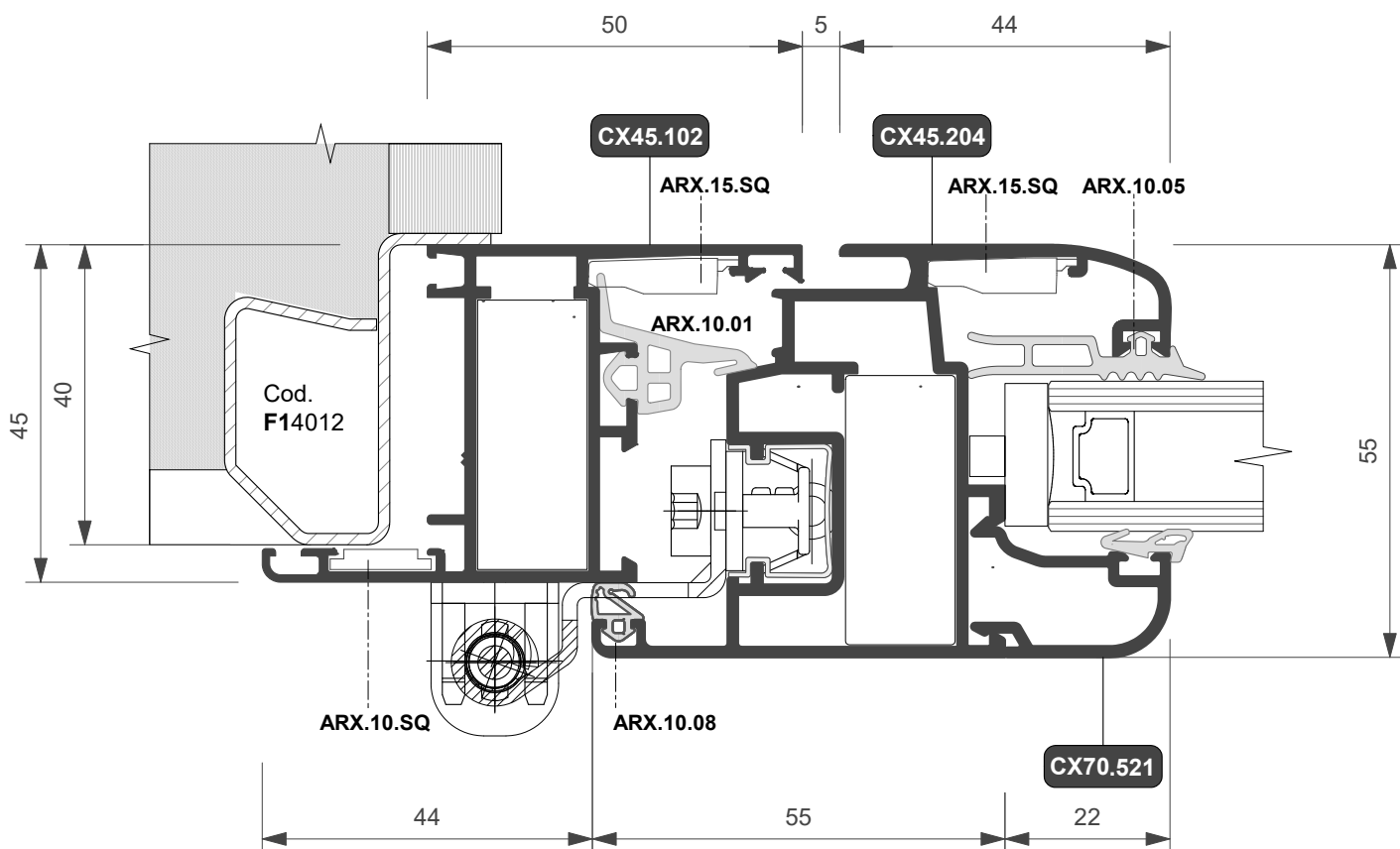
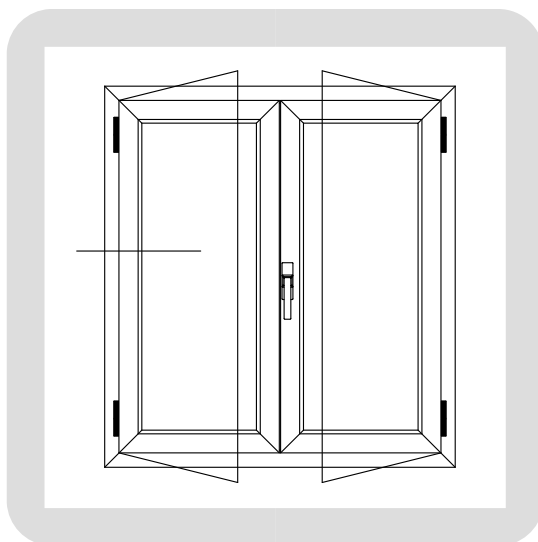



FINESTRA A DUE ANTE
Giunto aperto
Ferramenta a nastro

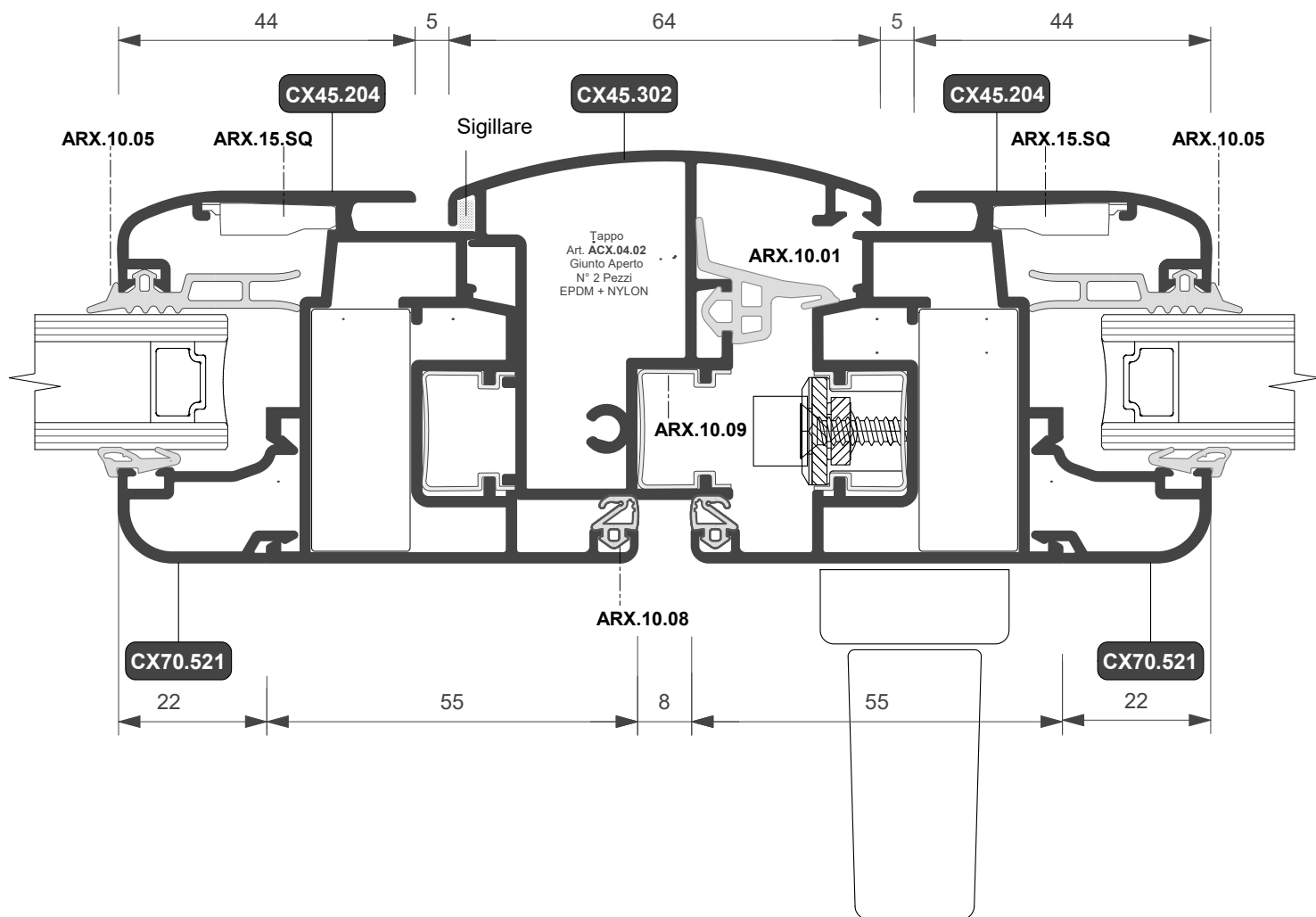
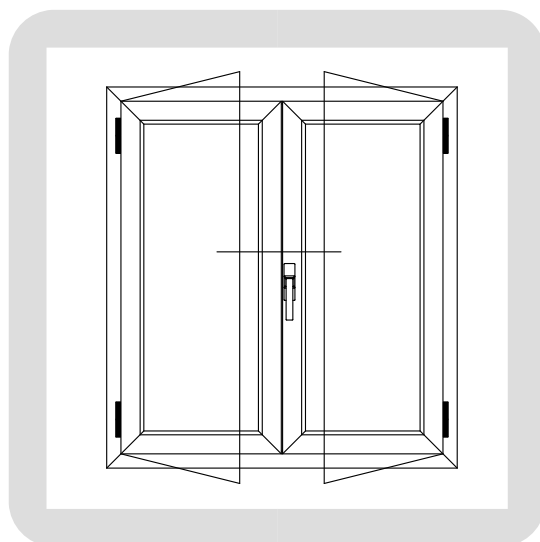



PORTA BALCONE A DUE ANTE
Giunto Aperto
Ferramenta a nastro

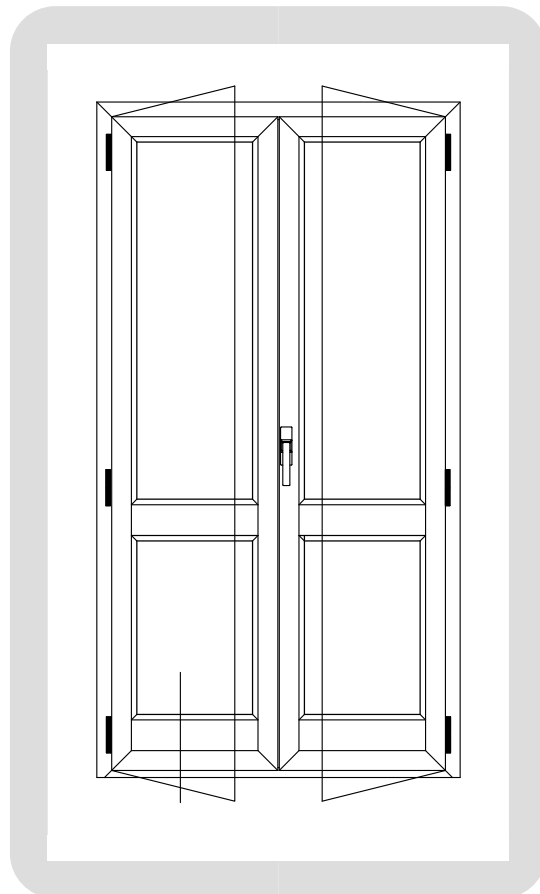
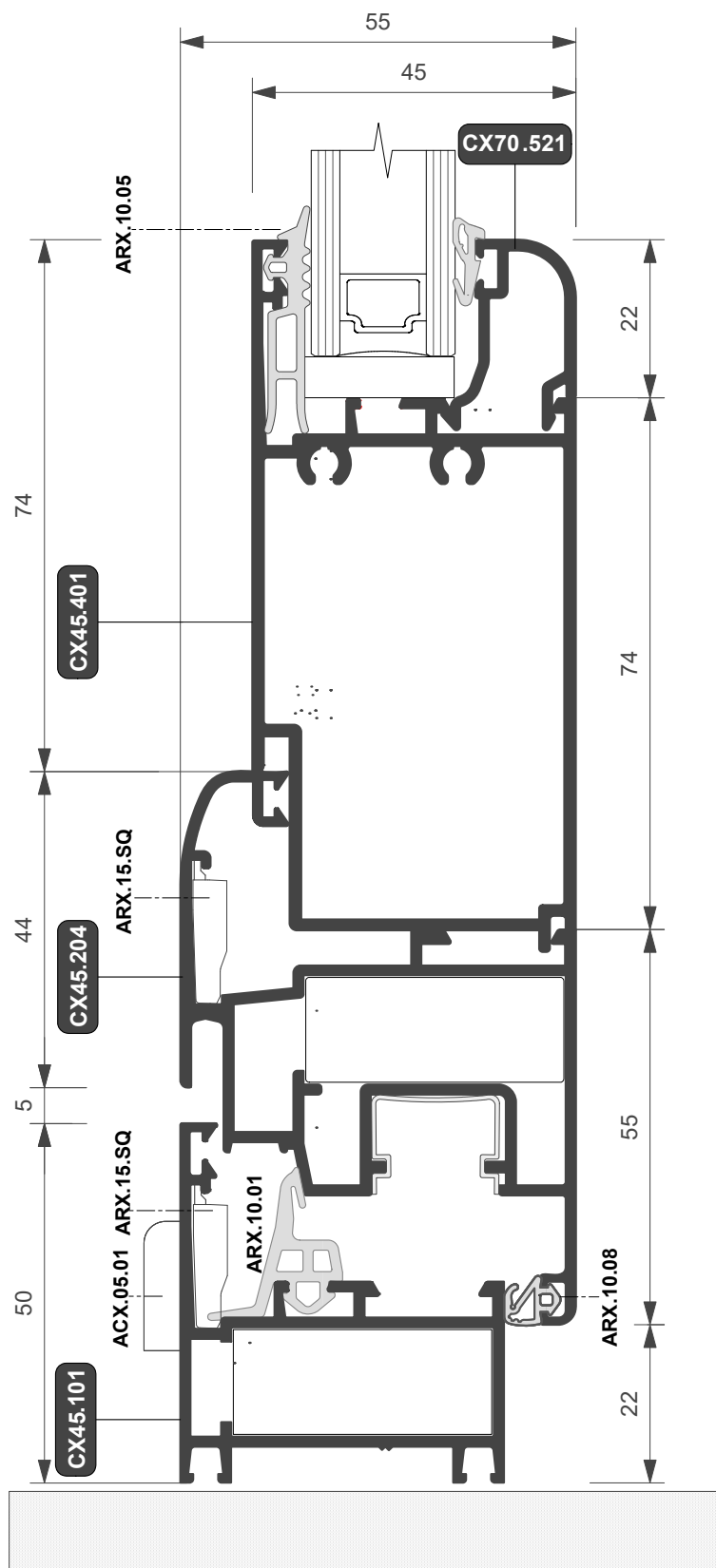



FINESTRA A DUE ANTE
Giunto aperto
Scorrevole parallelo

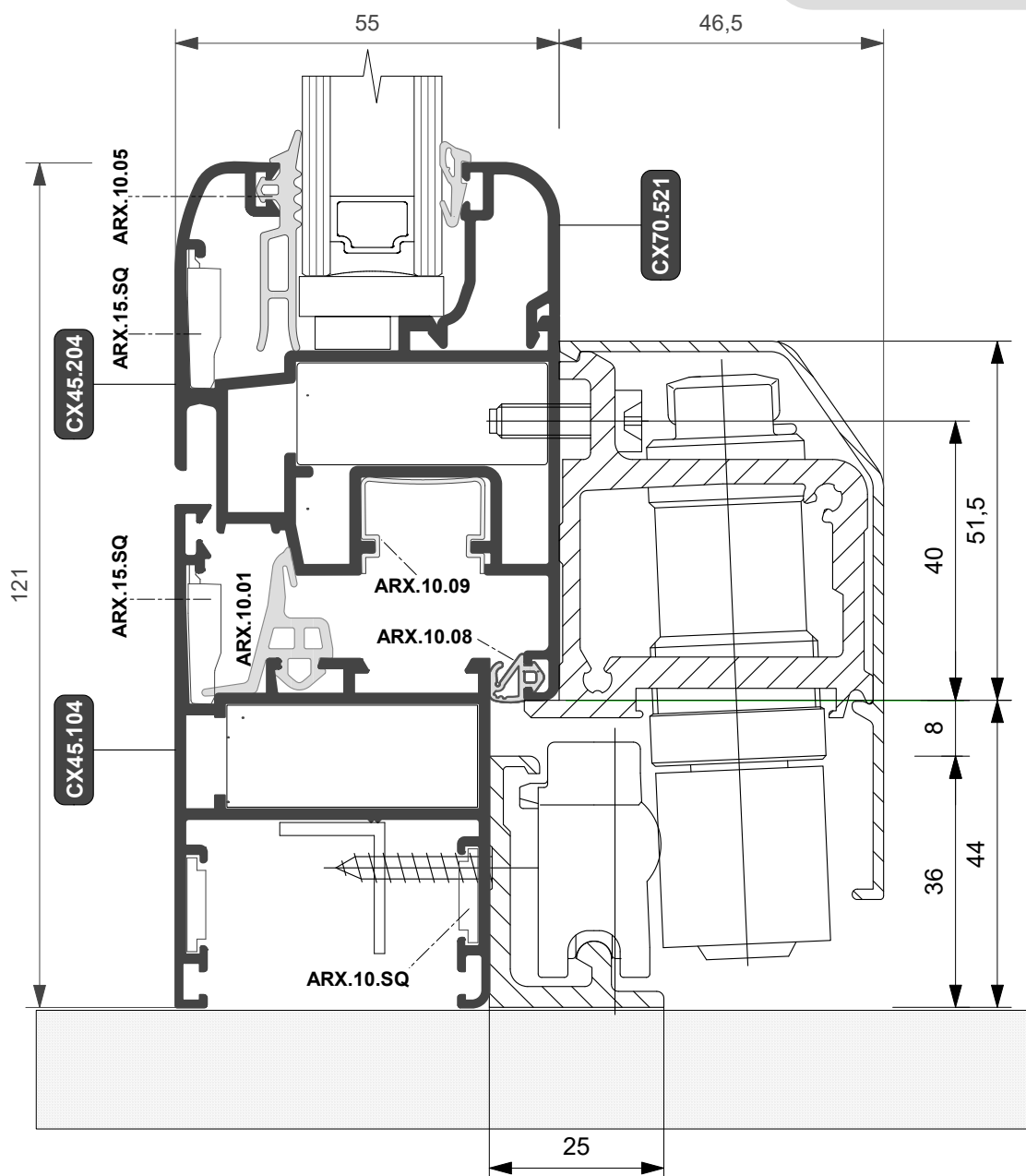
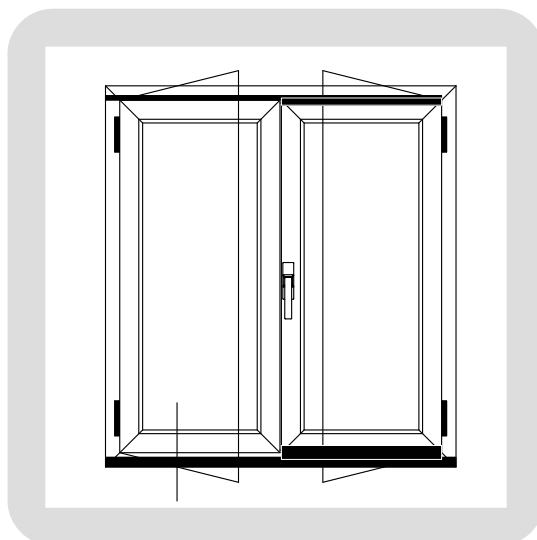



FINESTRA A DUE ANTE
Giunto aperto
Scorrevole parallelo

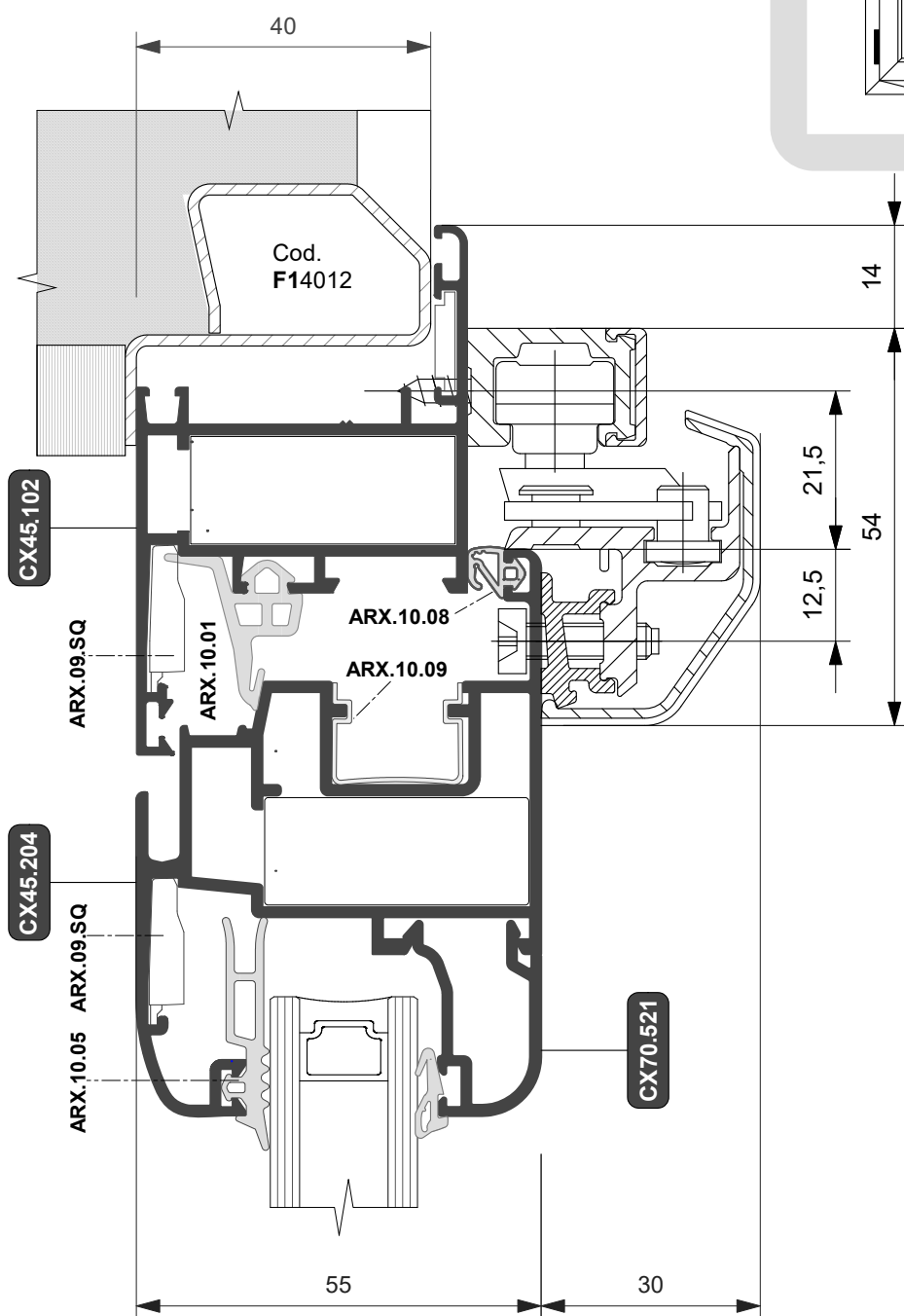
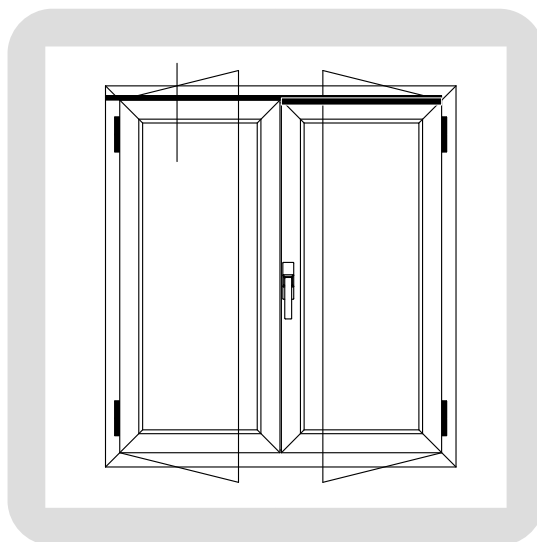

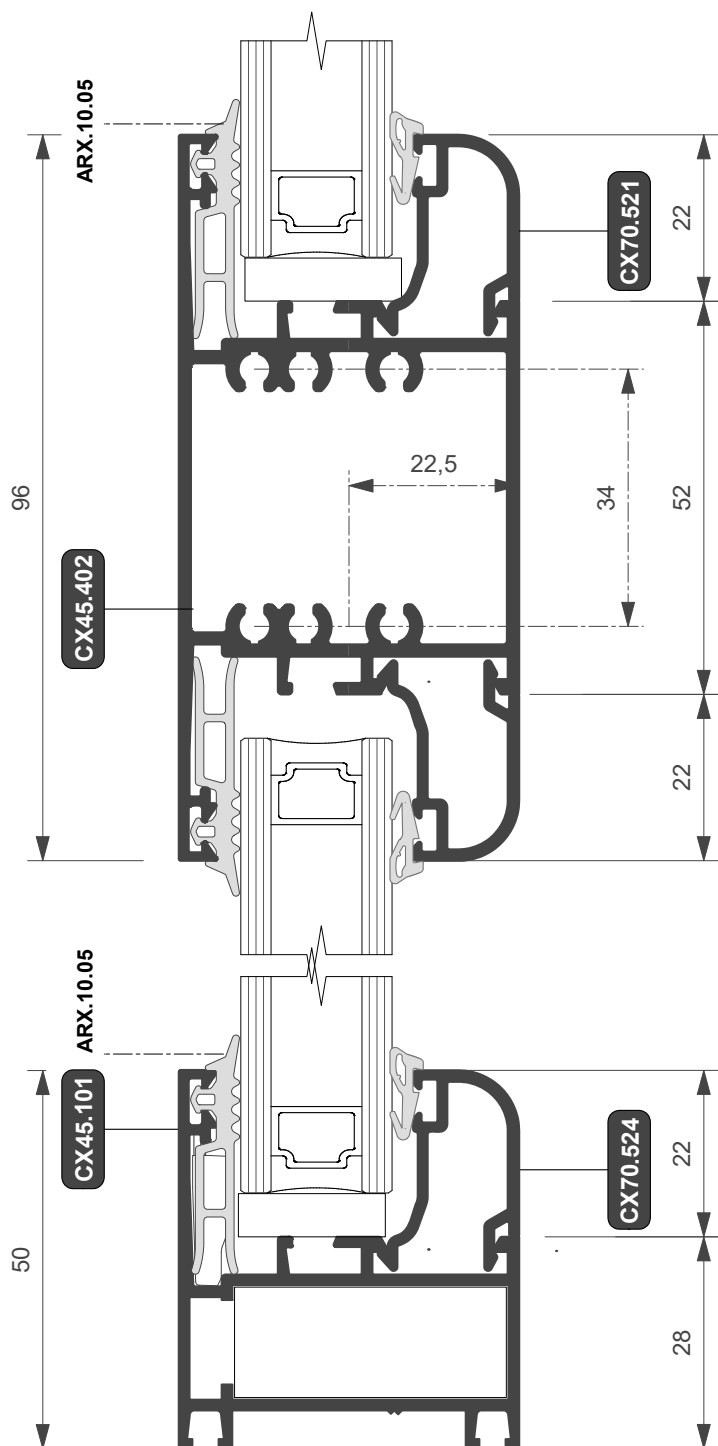

Elemento fisso

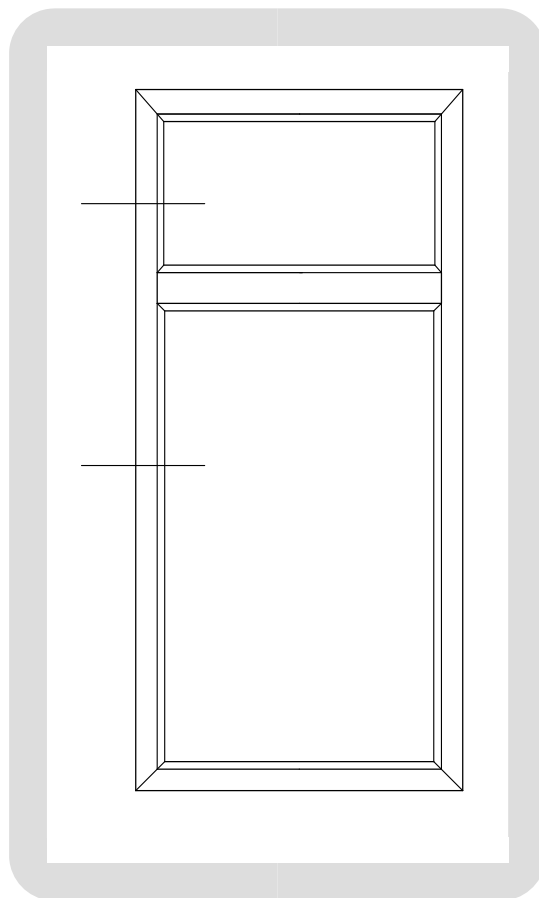



PORTA BALCONE A DUE ANTE
Giunto Aperto

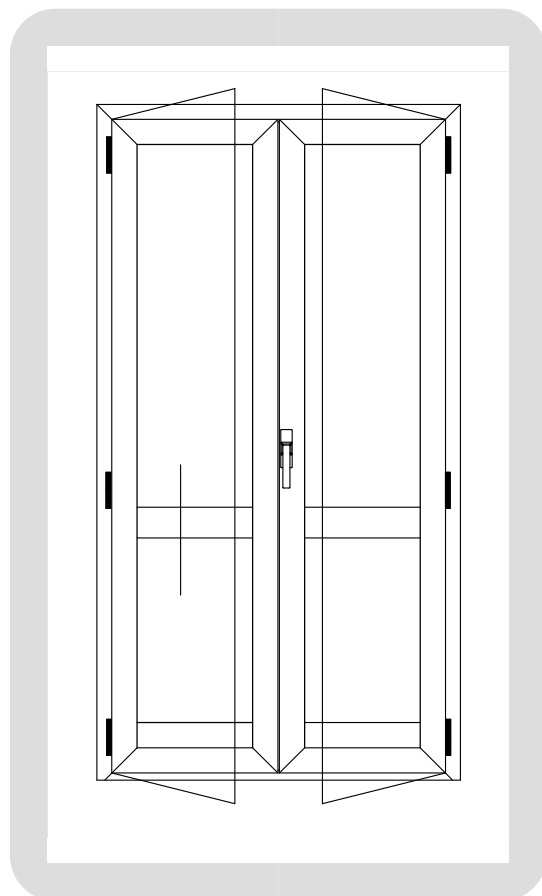
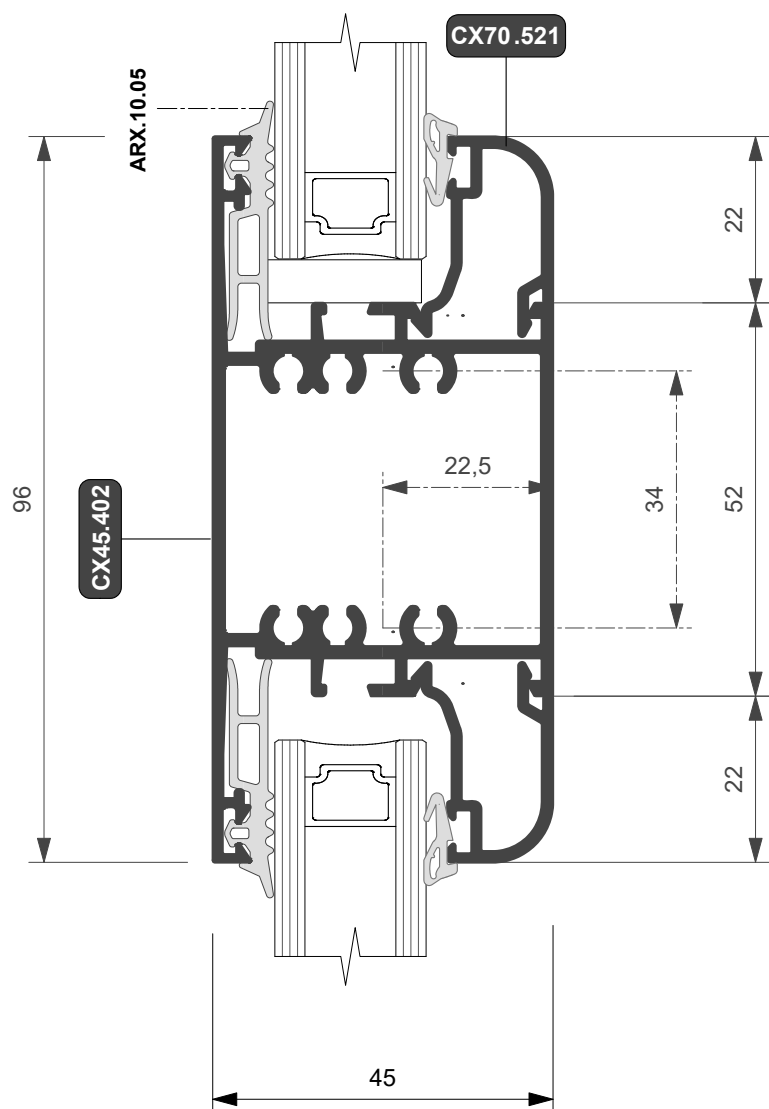



FINESTRA BILICO
ORIZZONTALE E VERTICALE

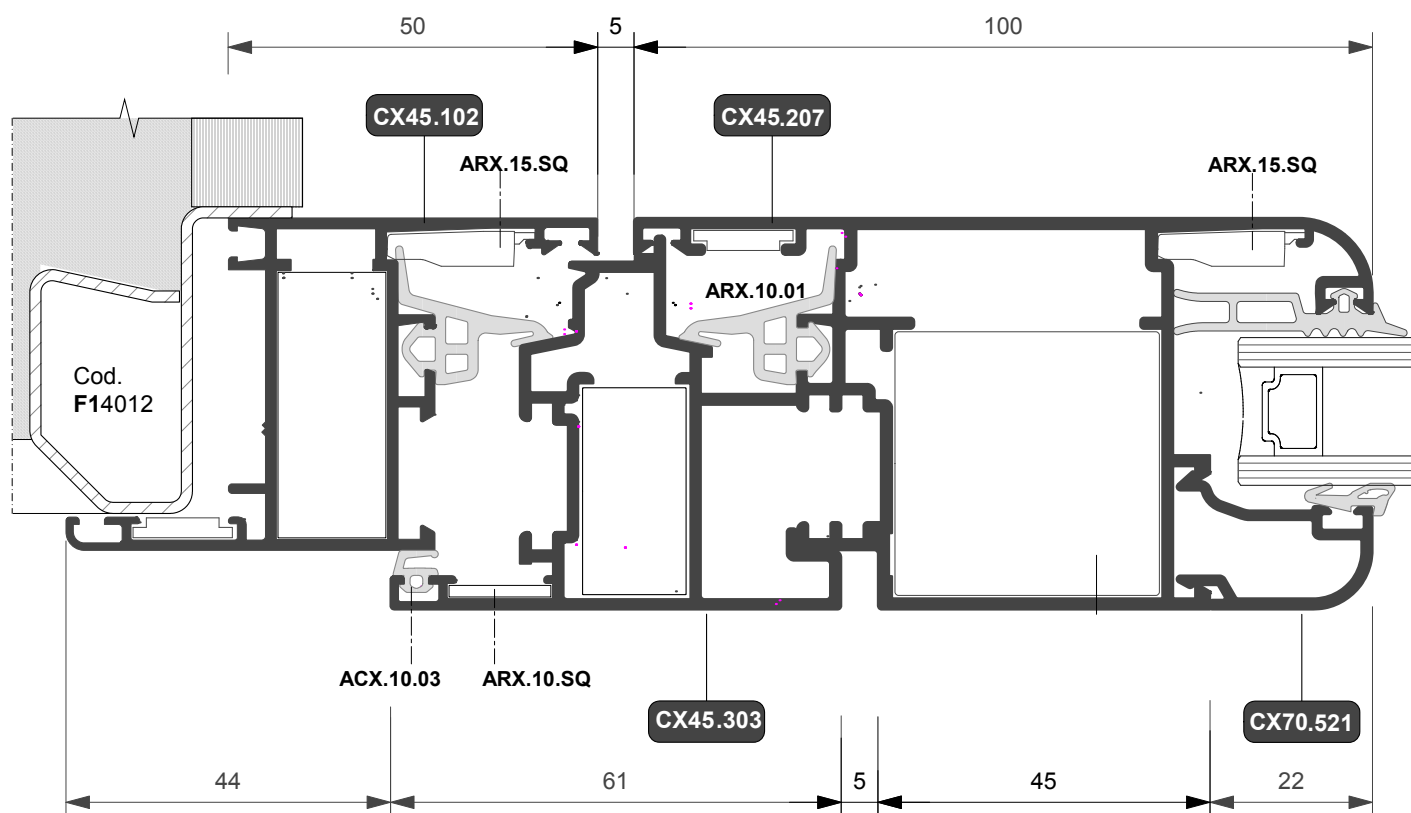
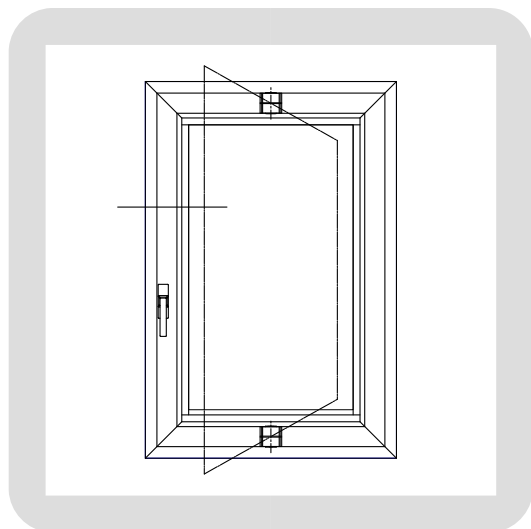
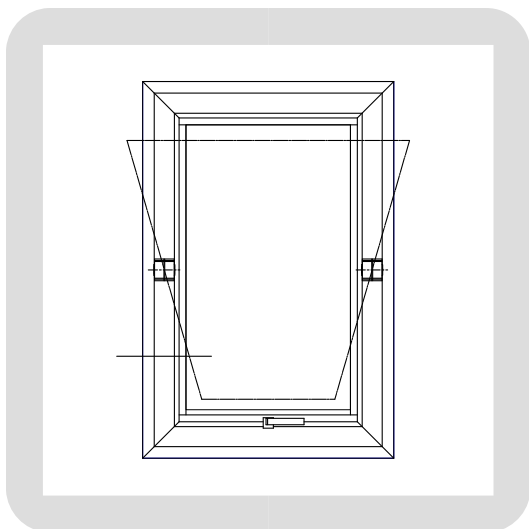



**FINESTRA BILICO
ORIZZONTALE E VERTICALE**

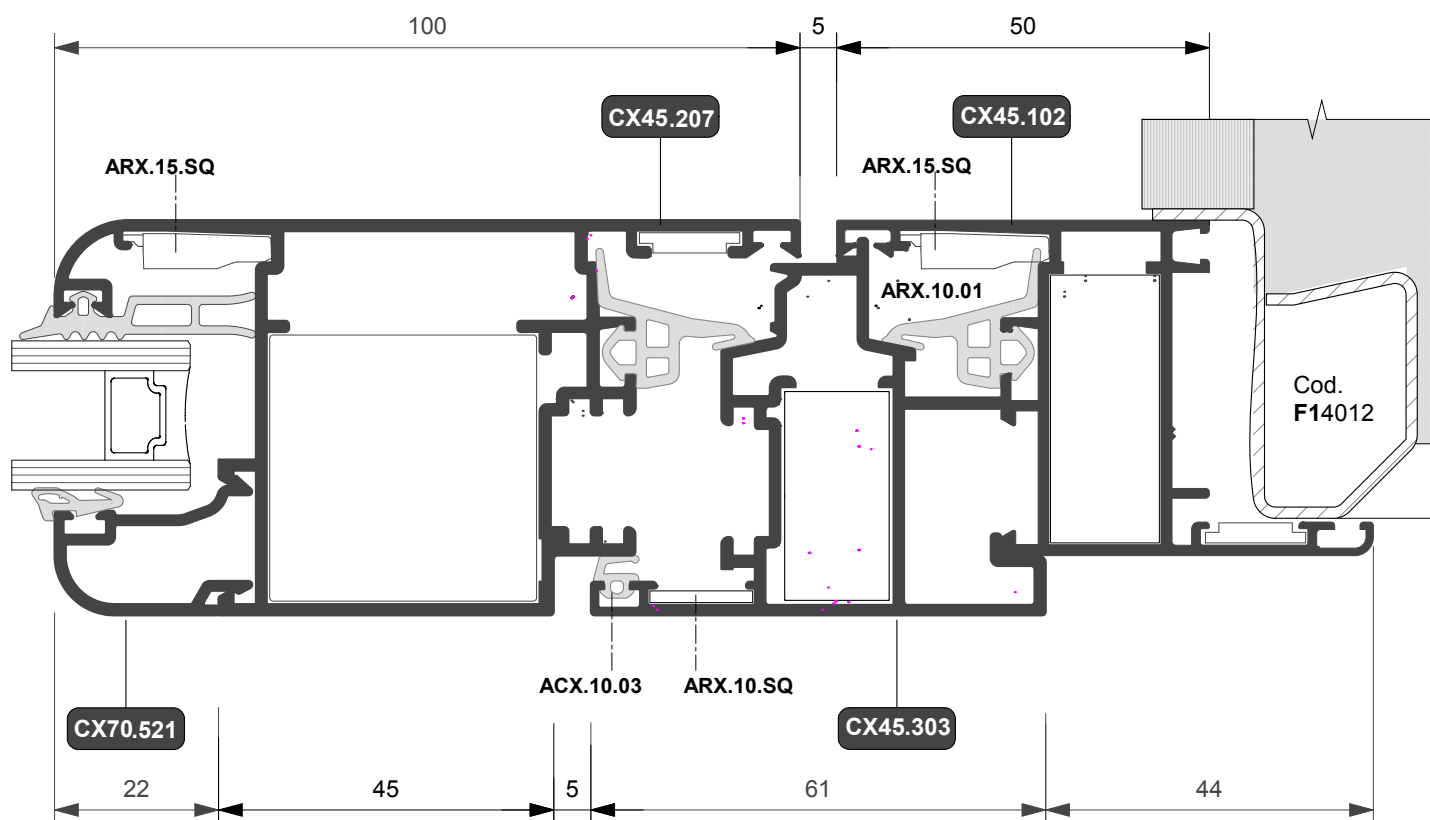
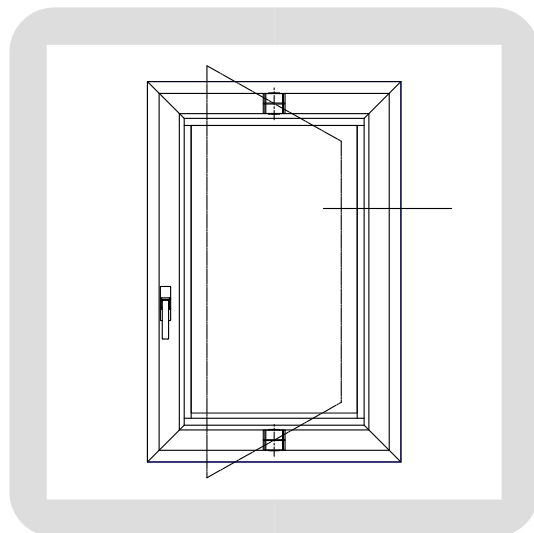
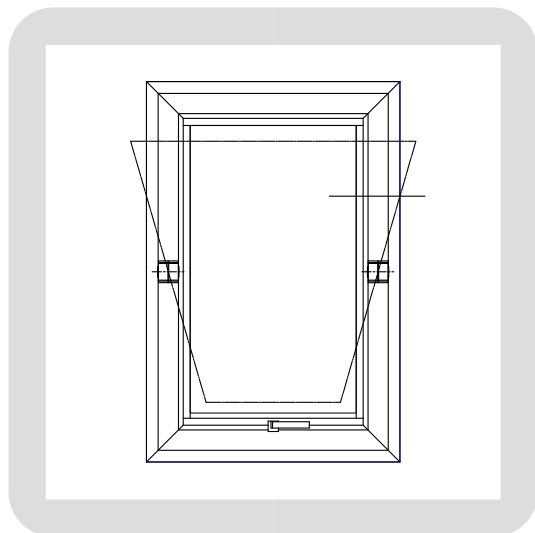

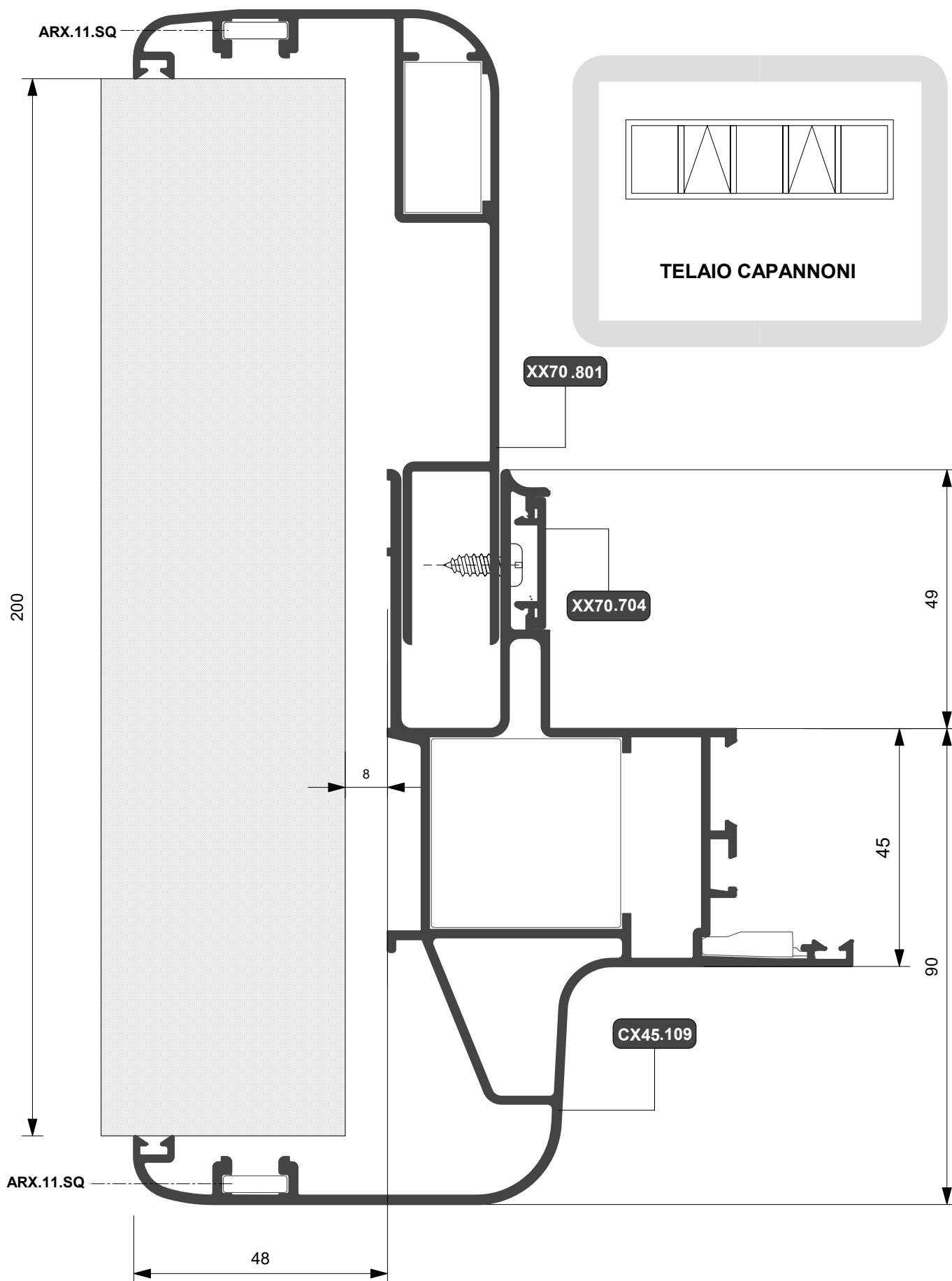



PORTA A DUE ANTE CON SOPRALUCE FISSO
Apertura esterna

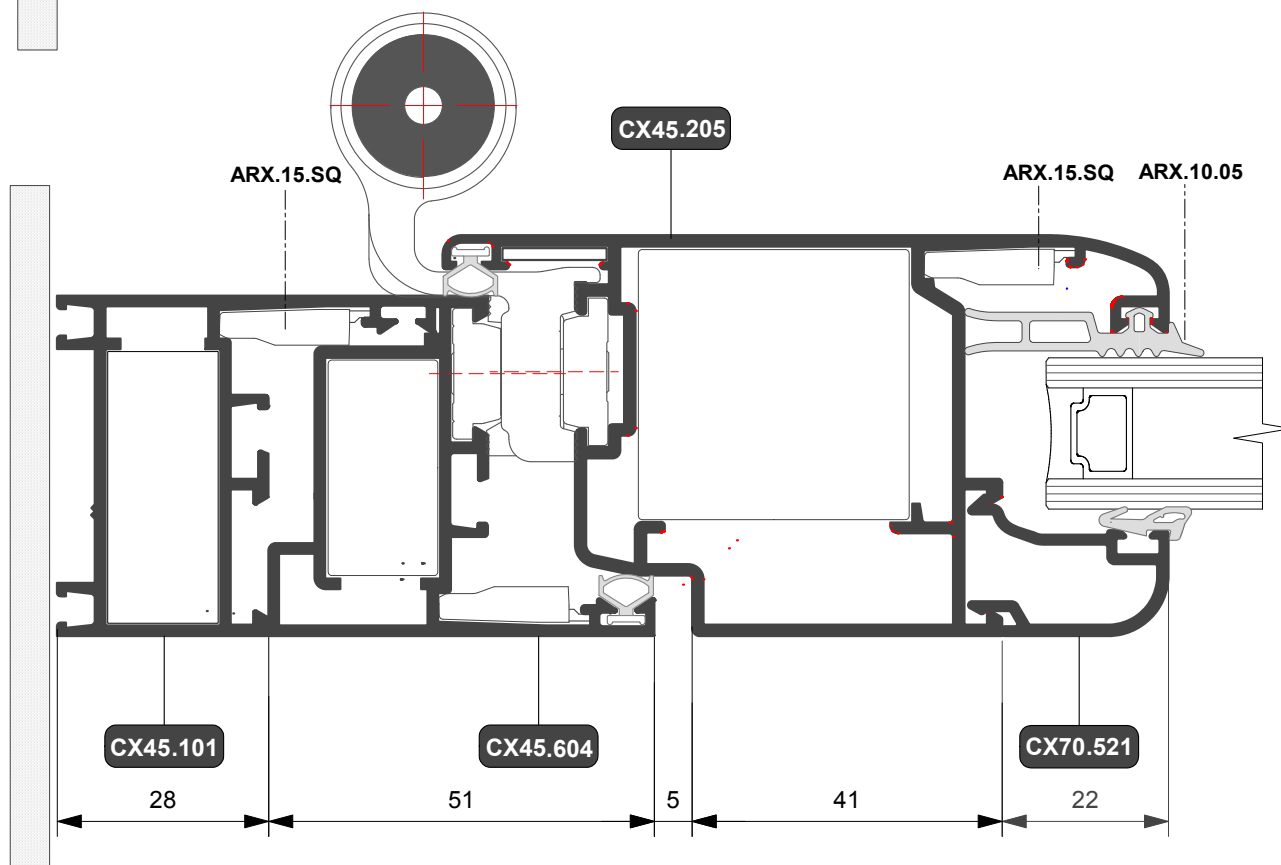
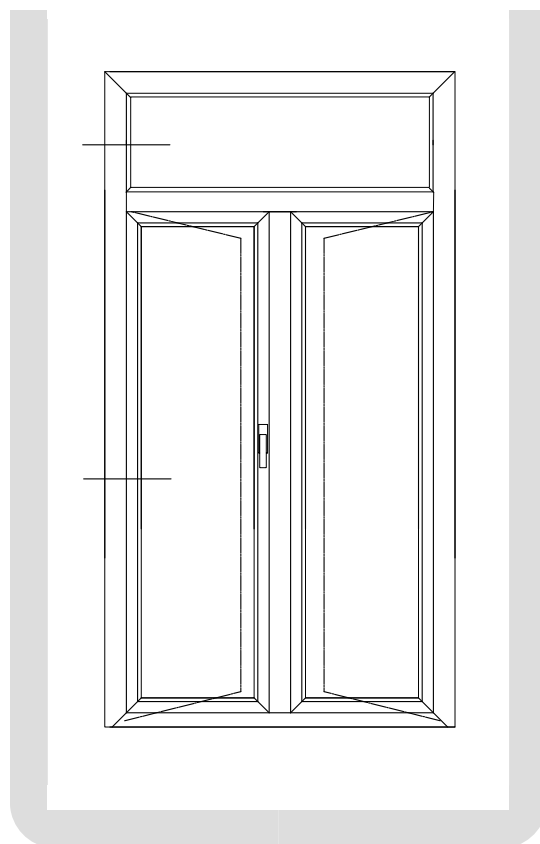
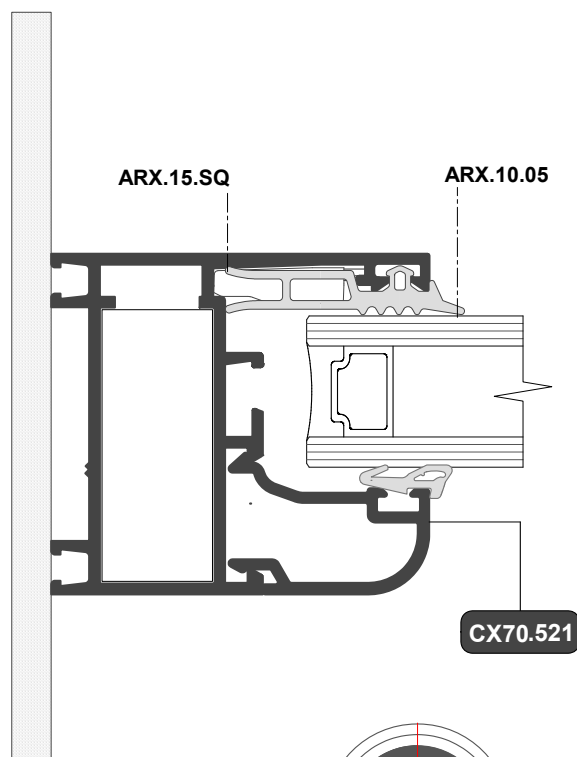



PORTA DI INGRESSO A 2 ANTE

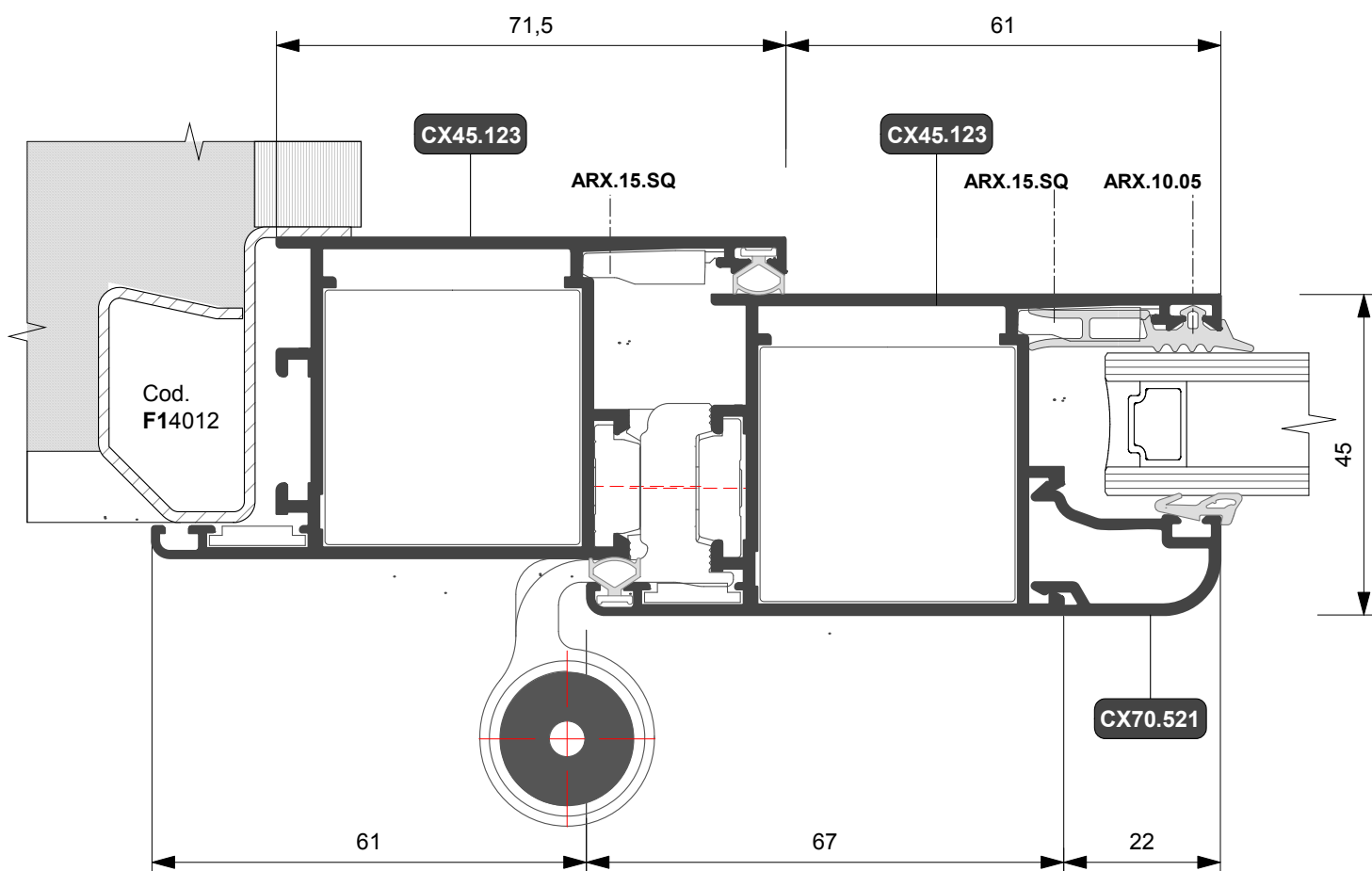
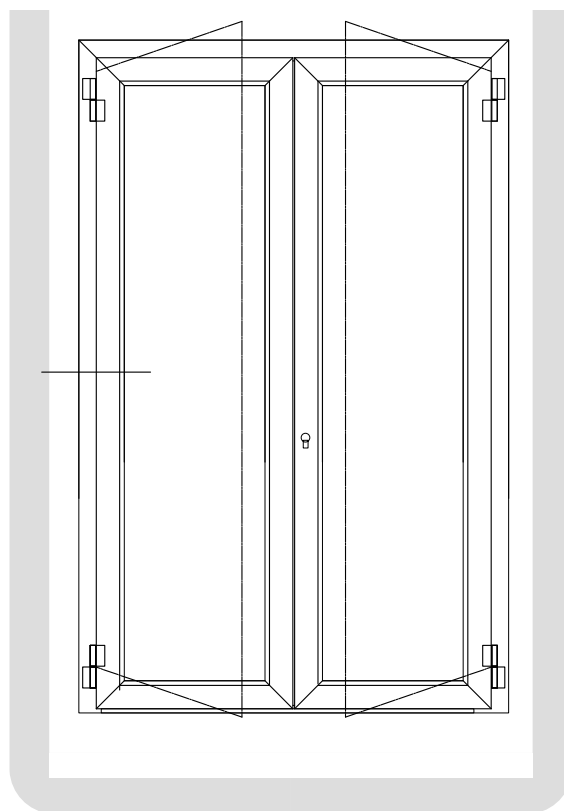



PORTA DI INGRESSO A 2 ANTE

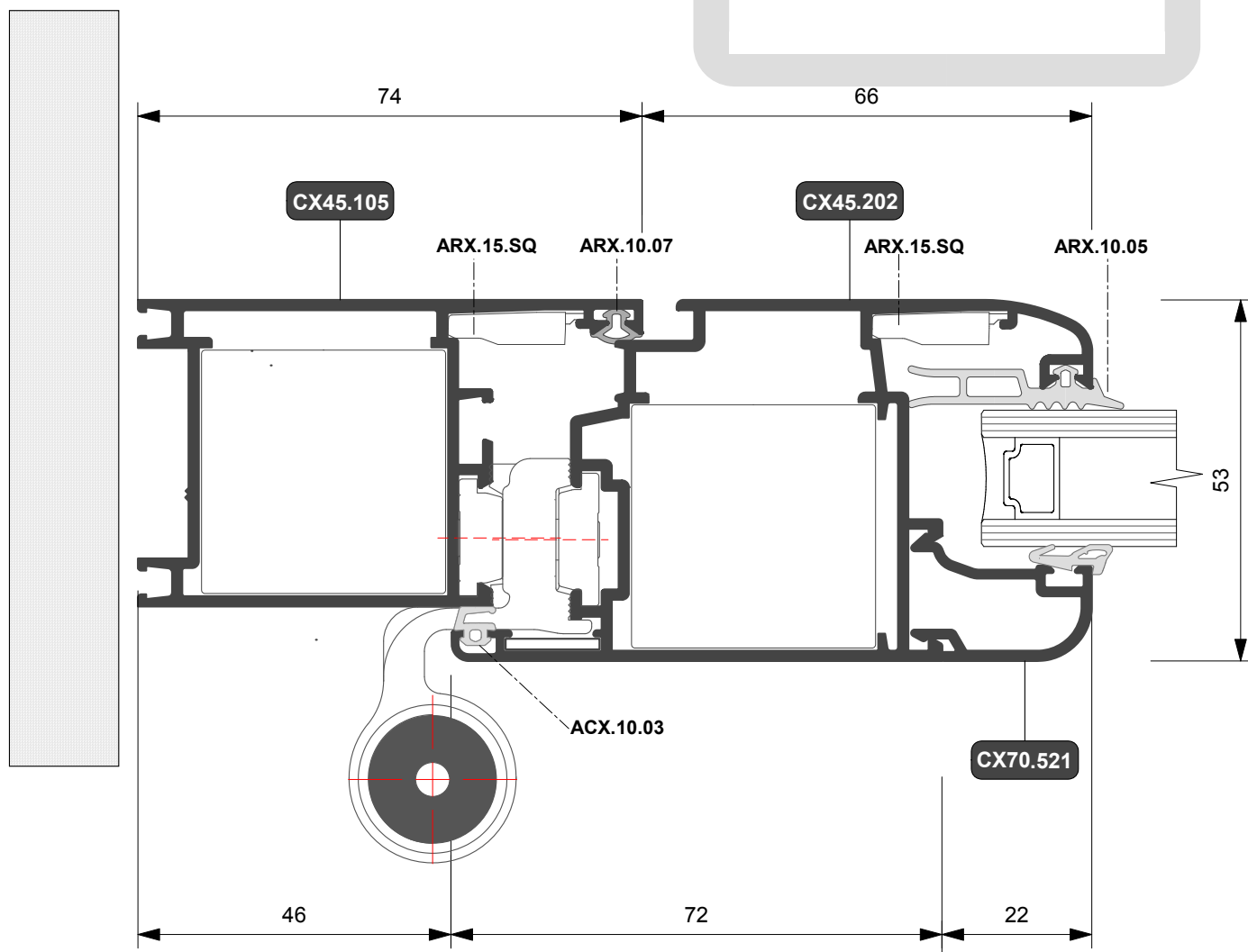
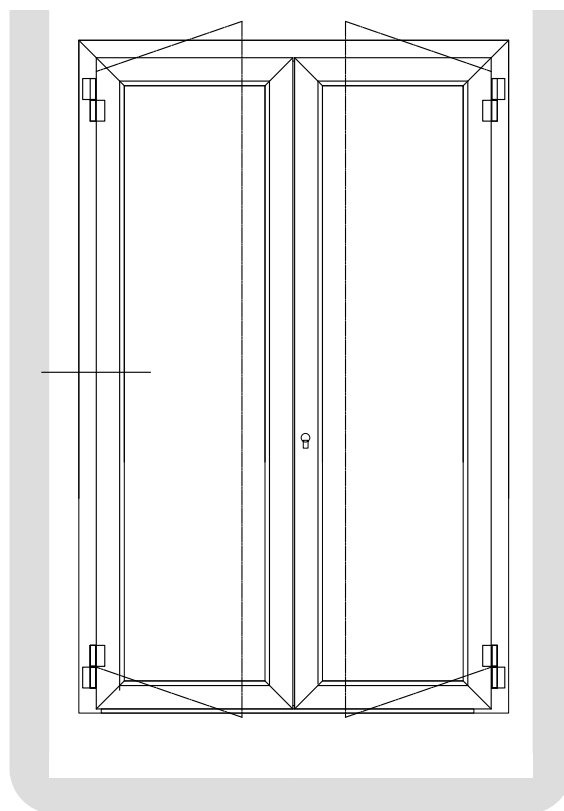



PORTA DI INGRESSO A 2 ANTE

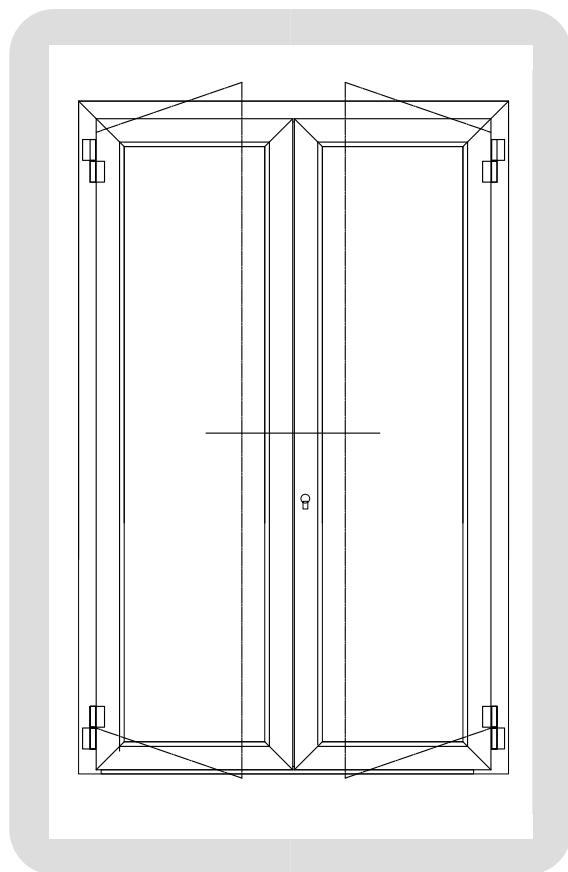
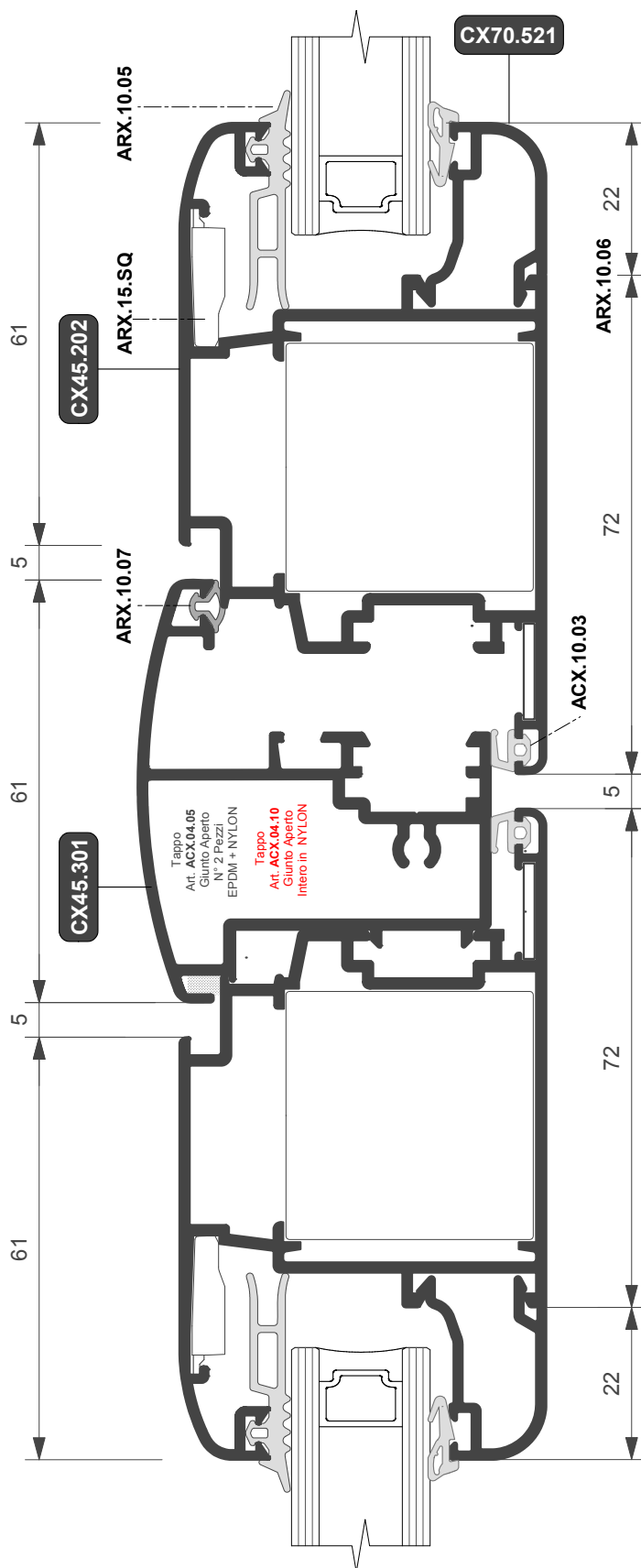



PORTA DI INGRESSO A 2 ANTE

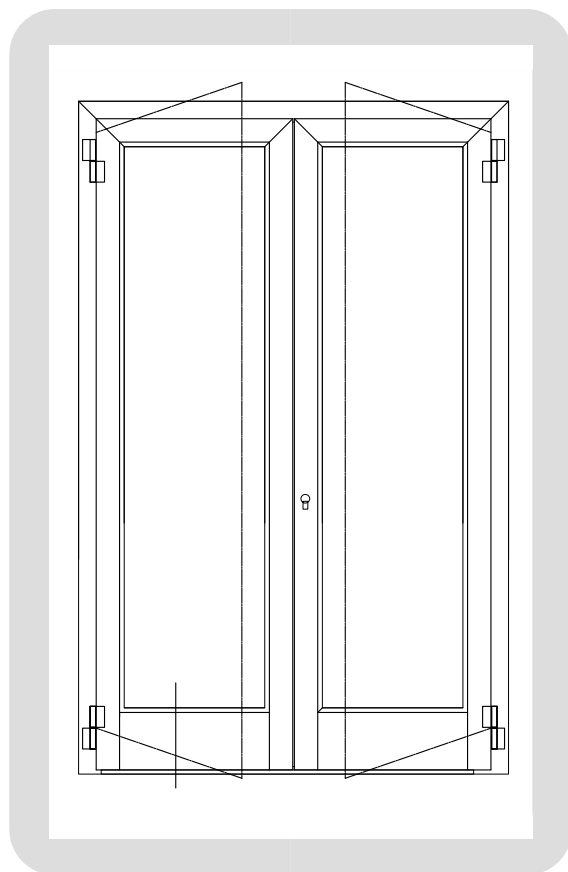
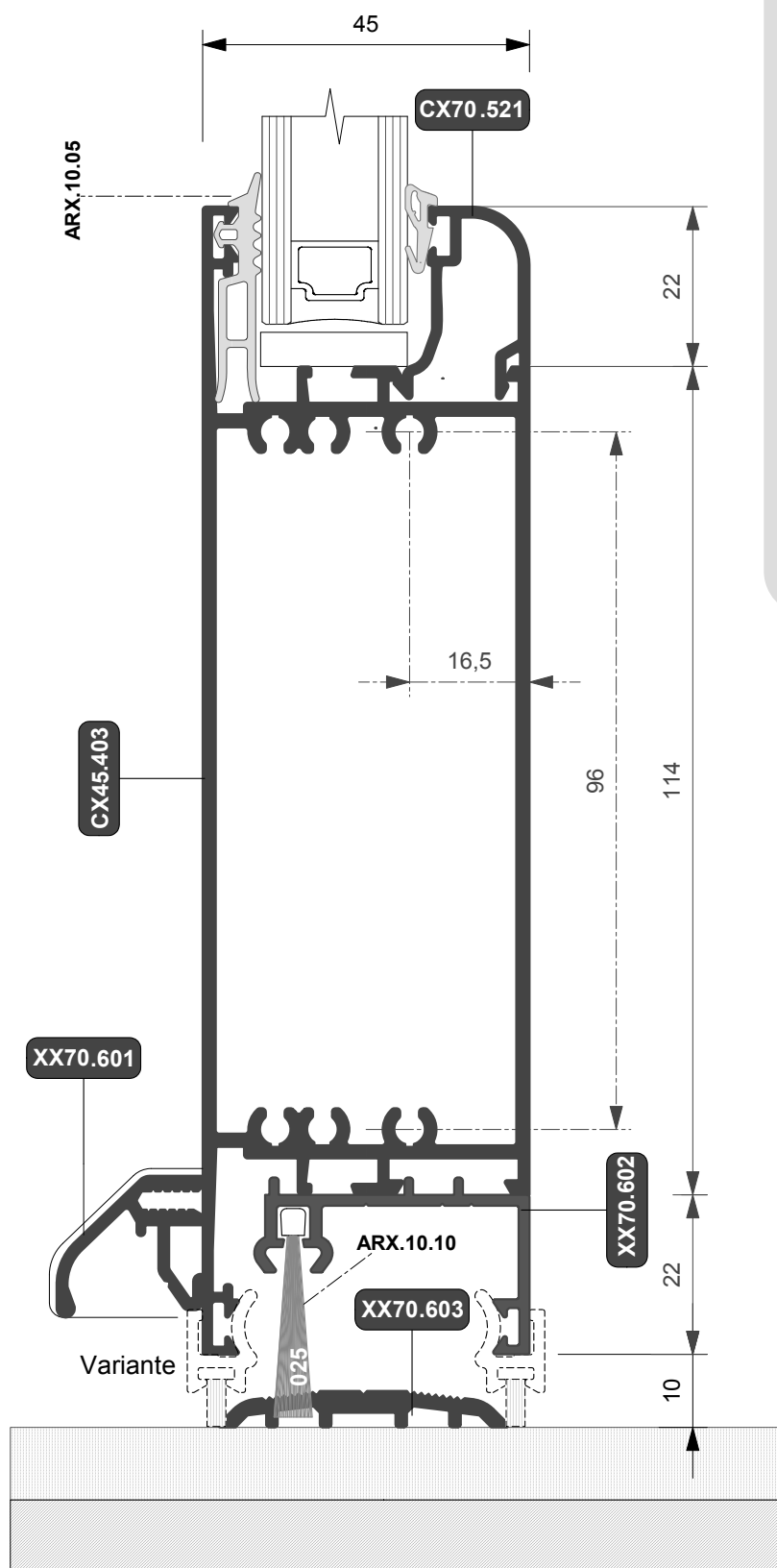



PORTA BALCONE A DUE ANTE
Giunto Aperto

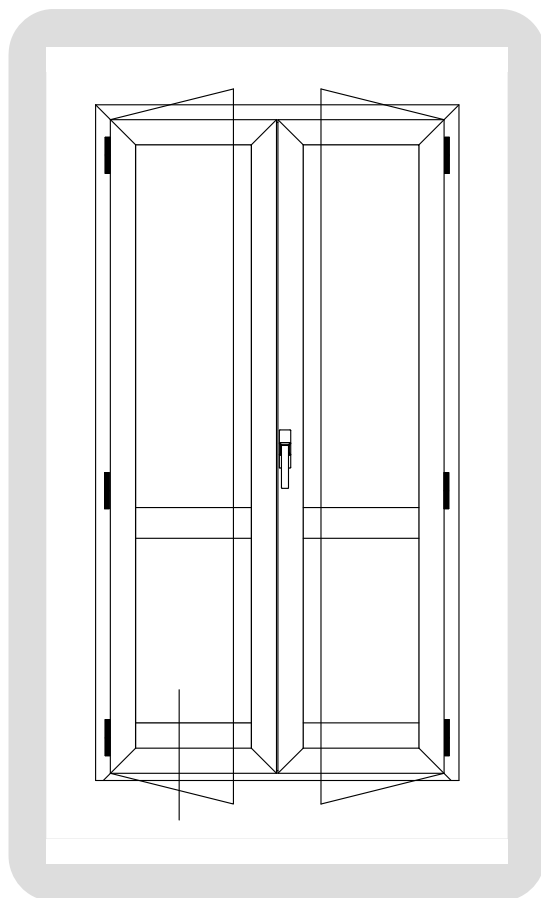
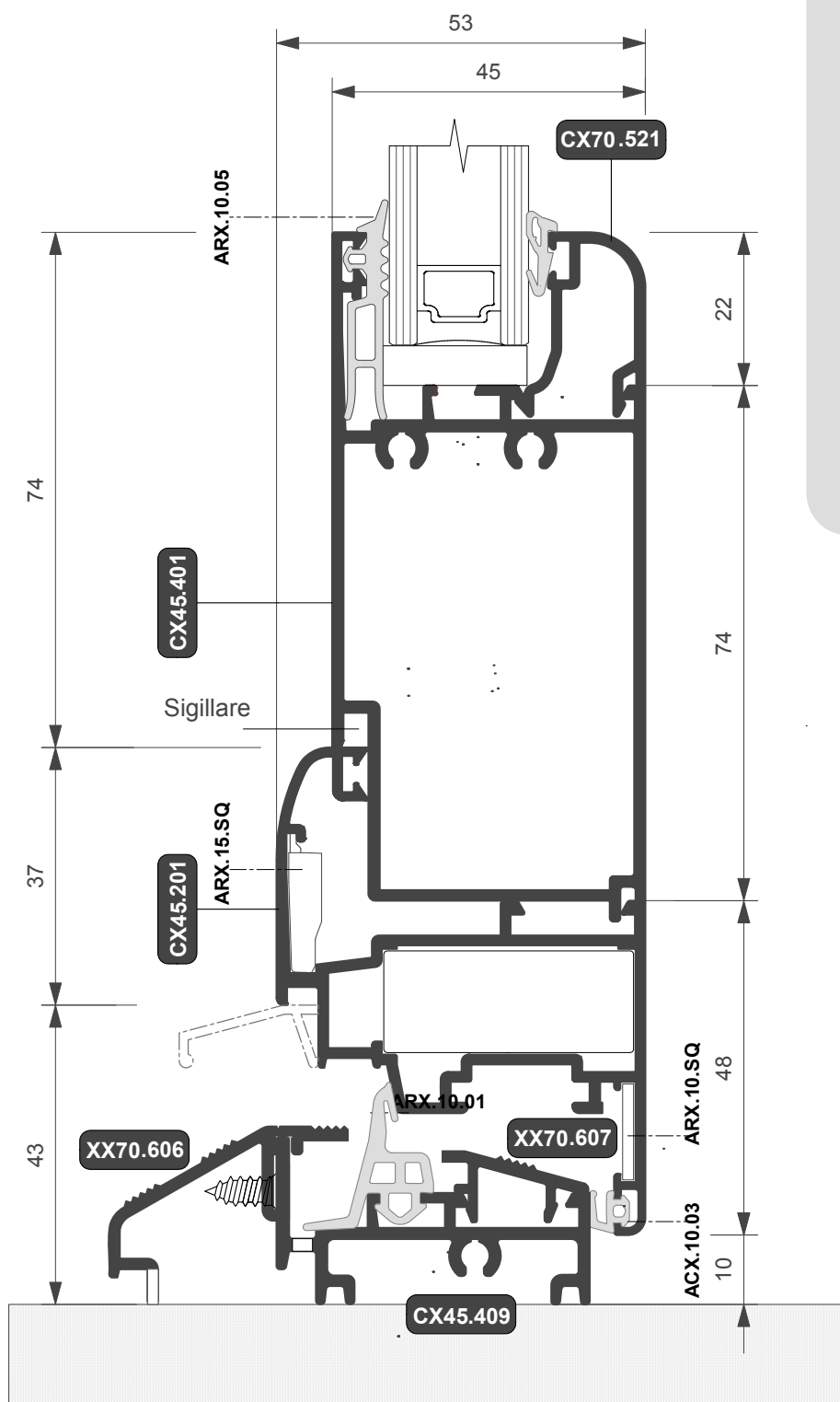

NB. I profili XX70.606 e XX70.607 vanno rifilati



FINESTRA MONOBLOCCO

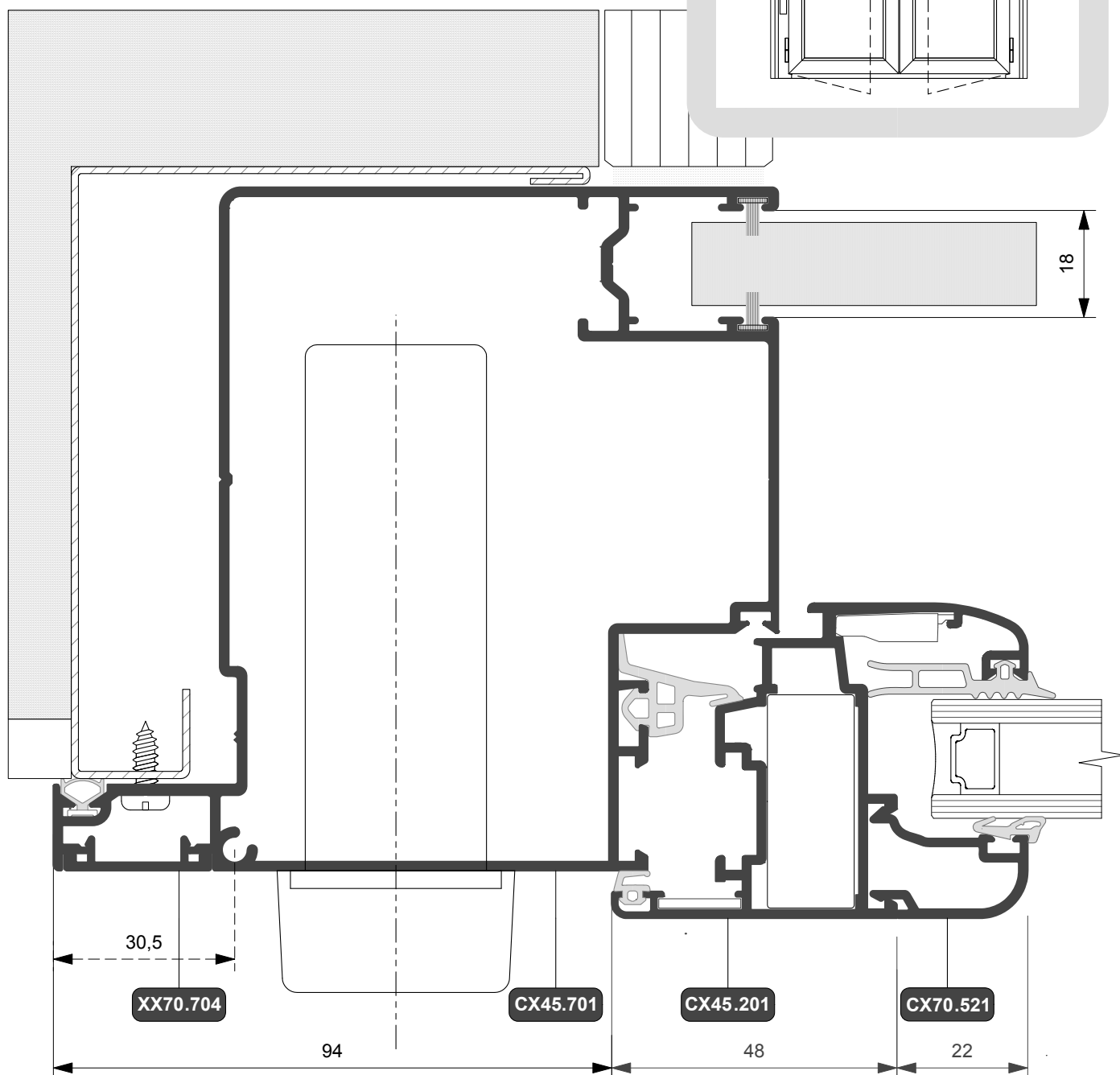
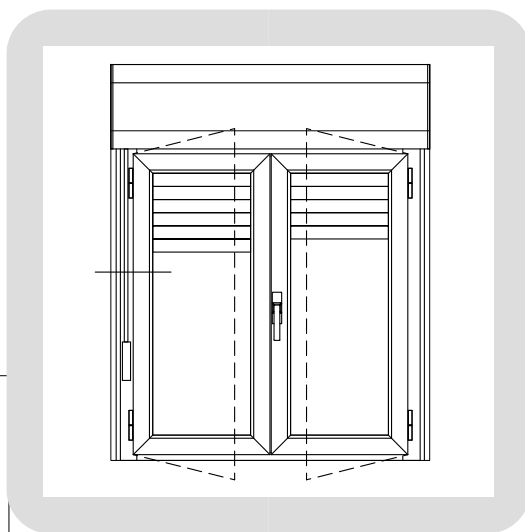



FINESTRA MONOBLOCCO

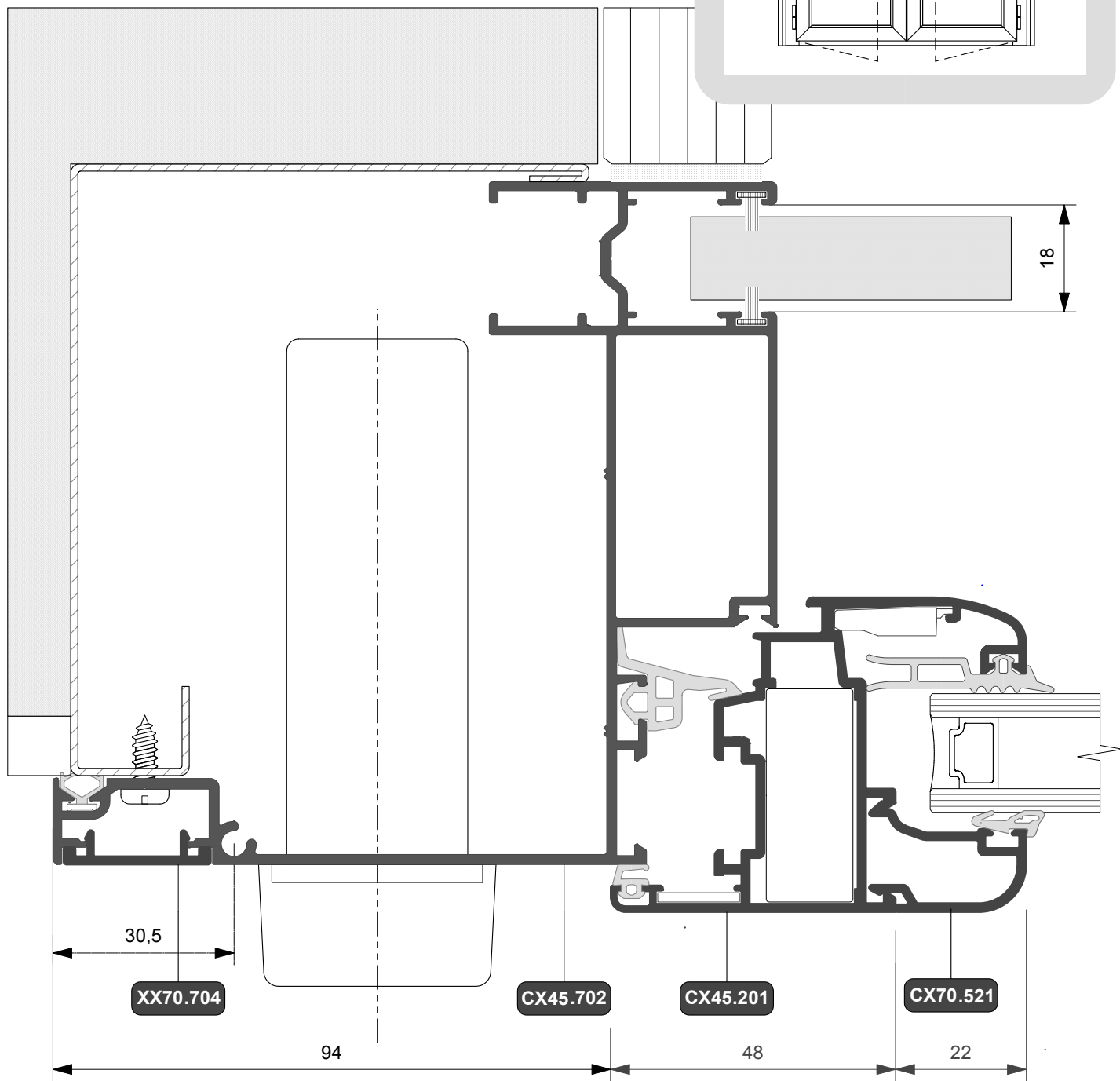
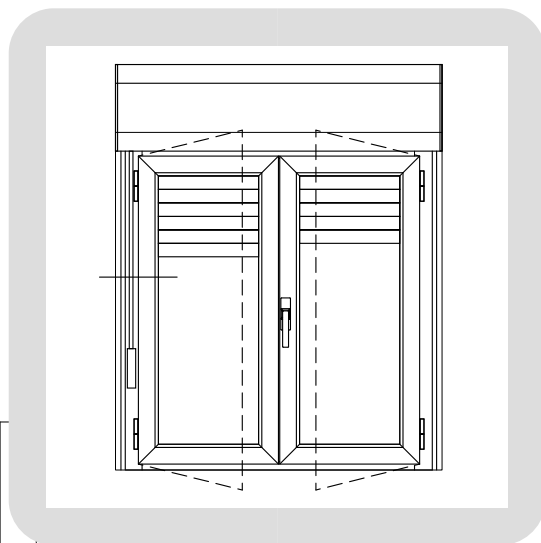



FINESTRA MONOBLOCCO

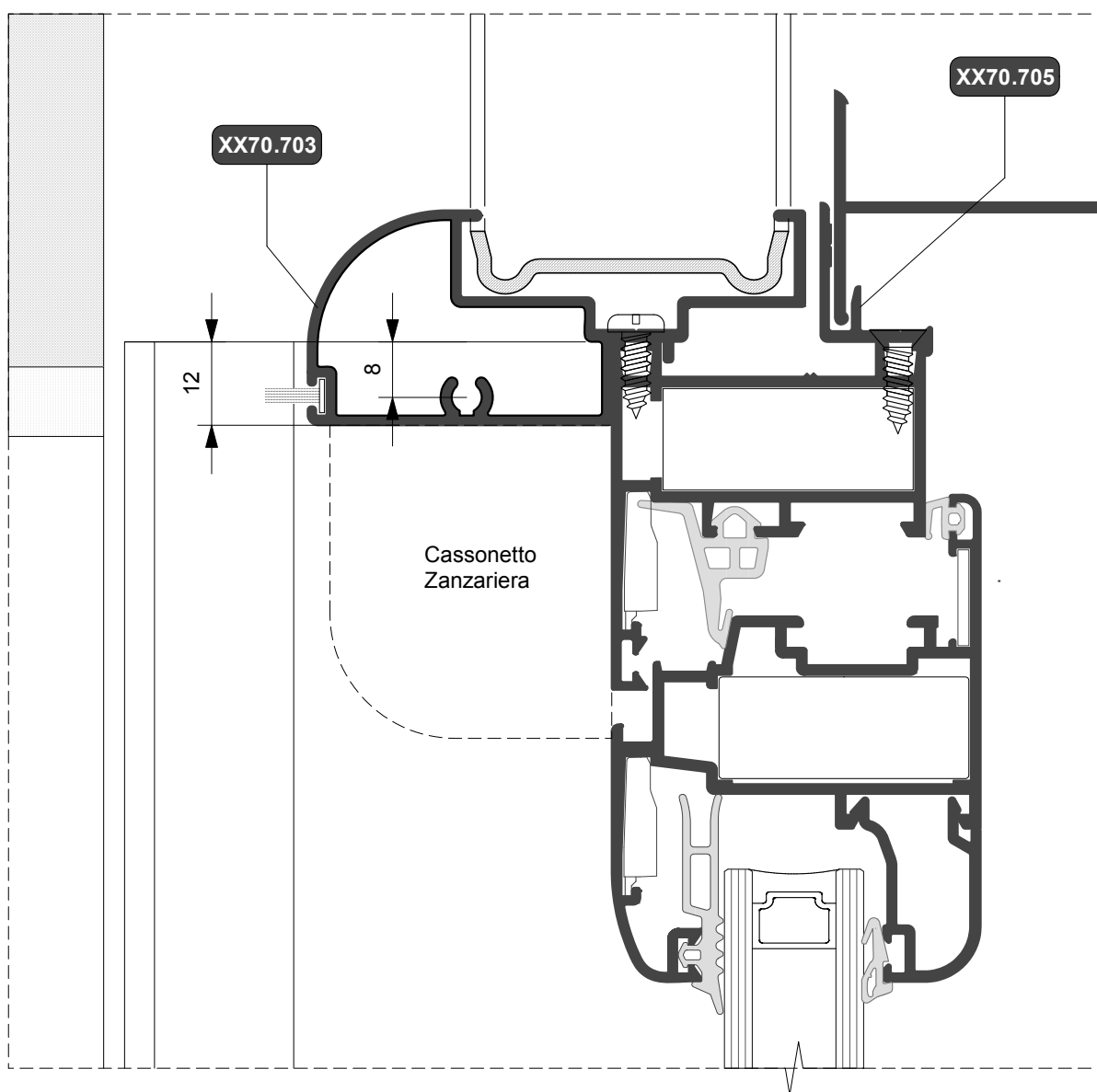
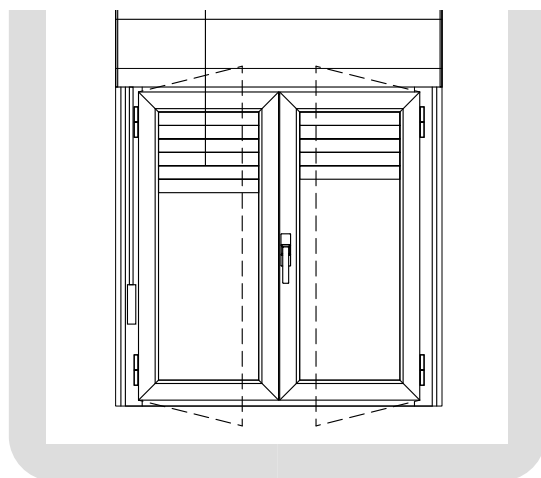

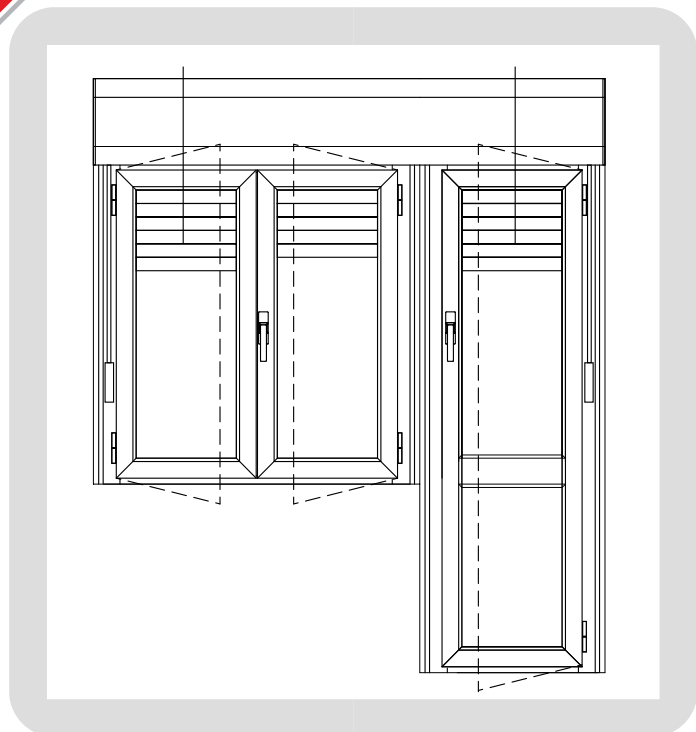

FINESTRA MONOBLOCCO

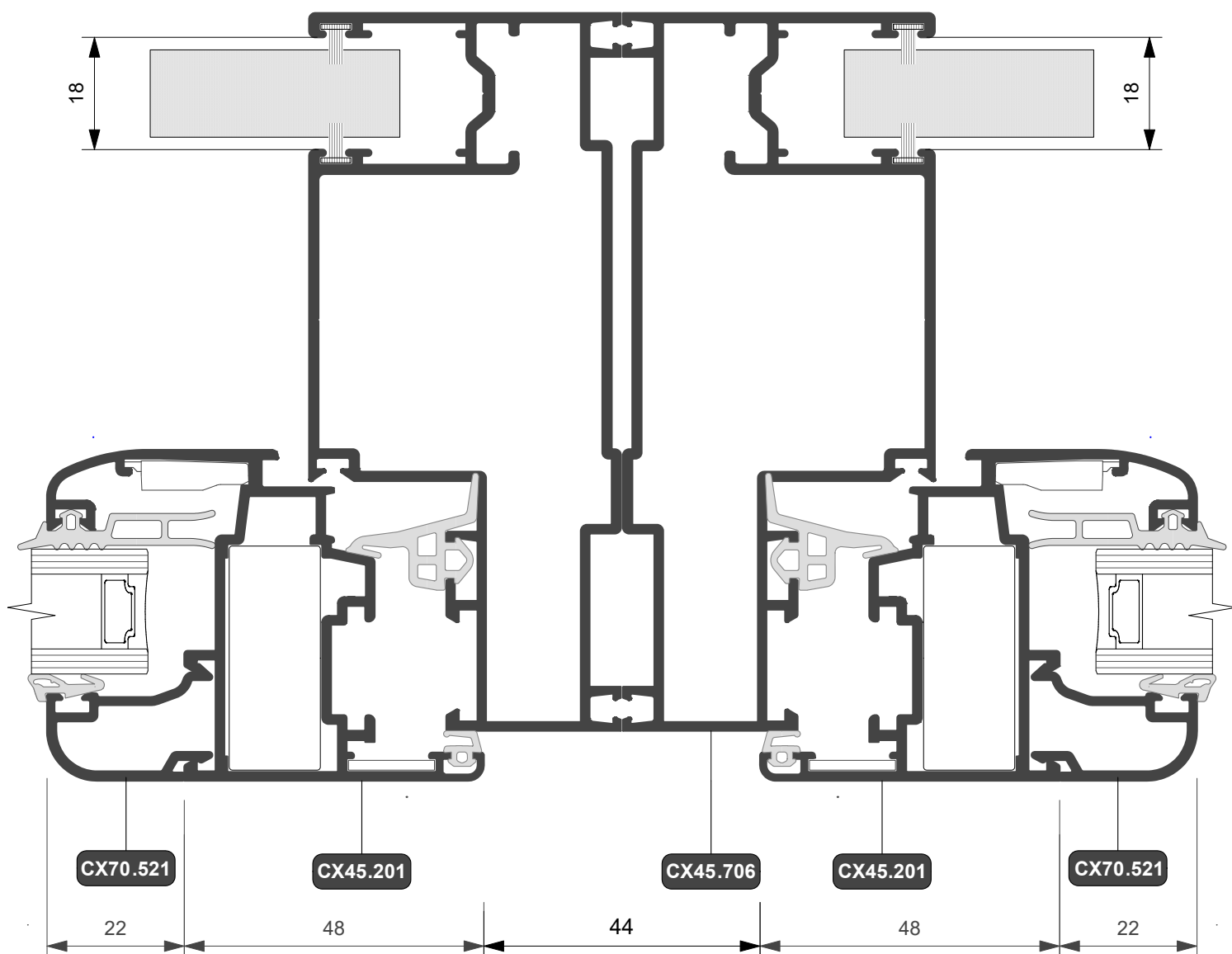



FINESTRA MONOBLOCCO

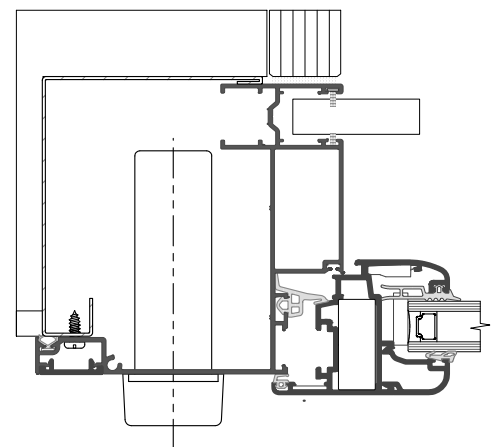
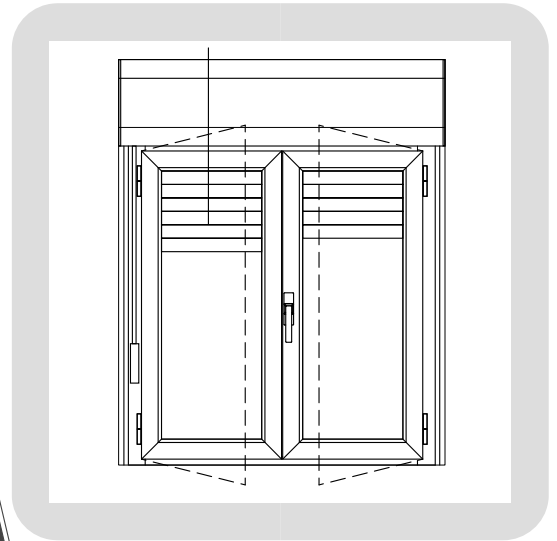
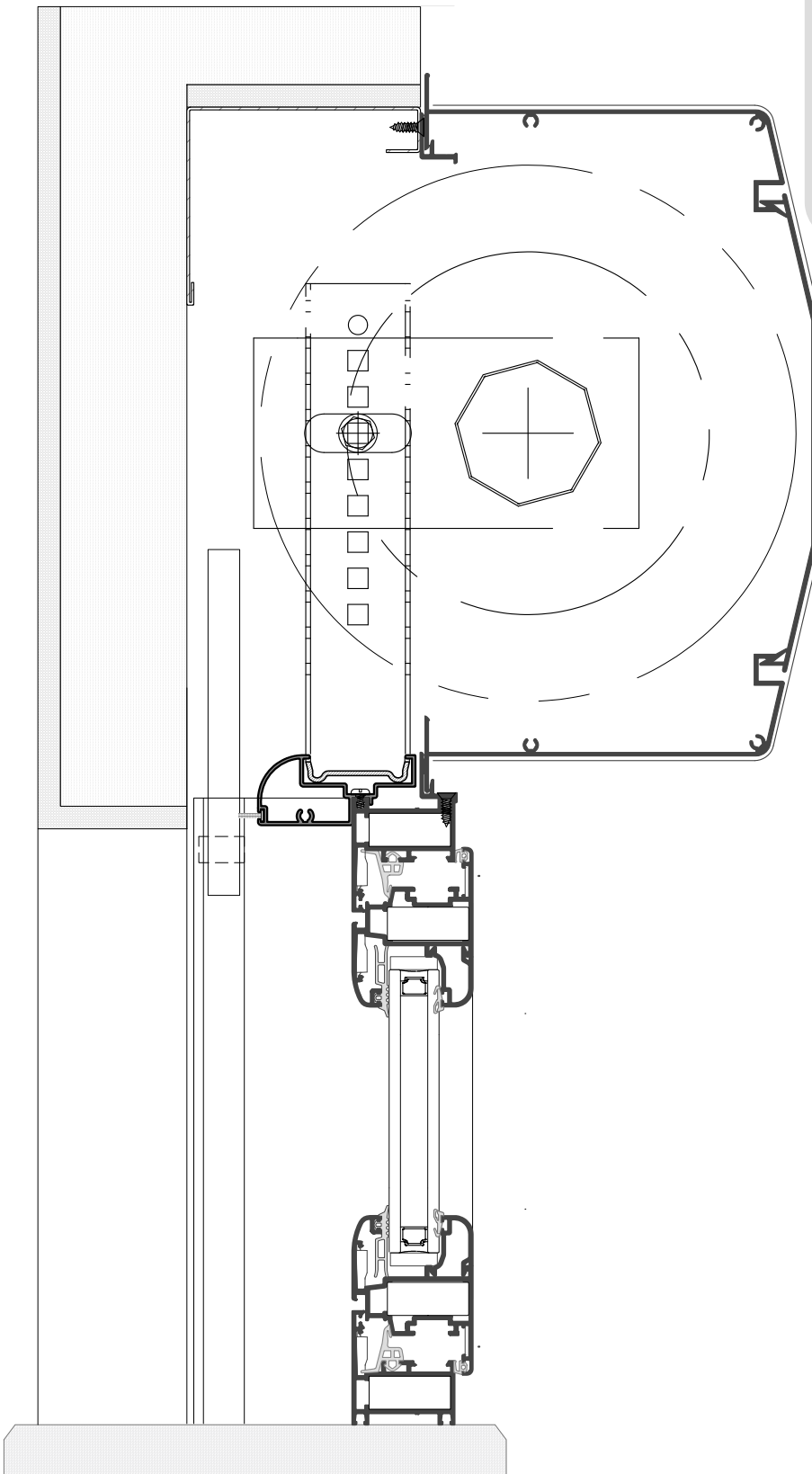

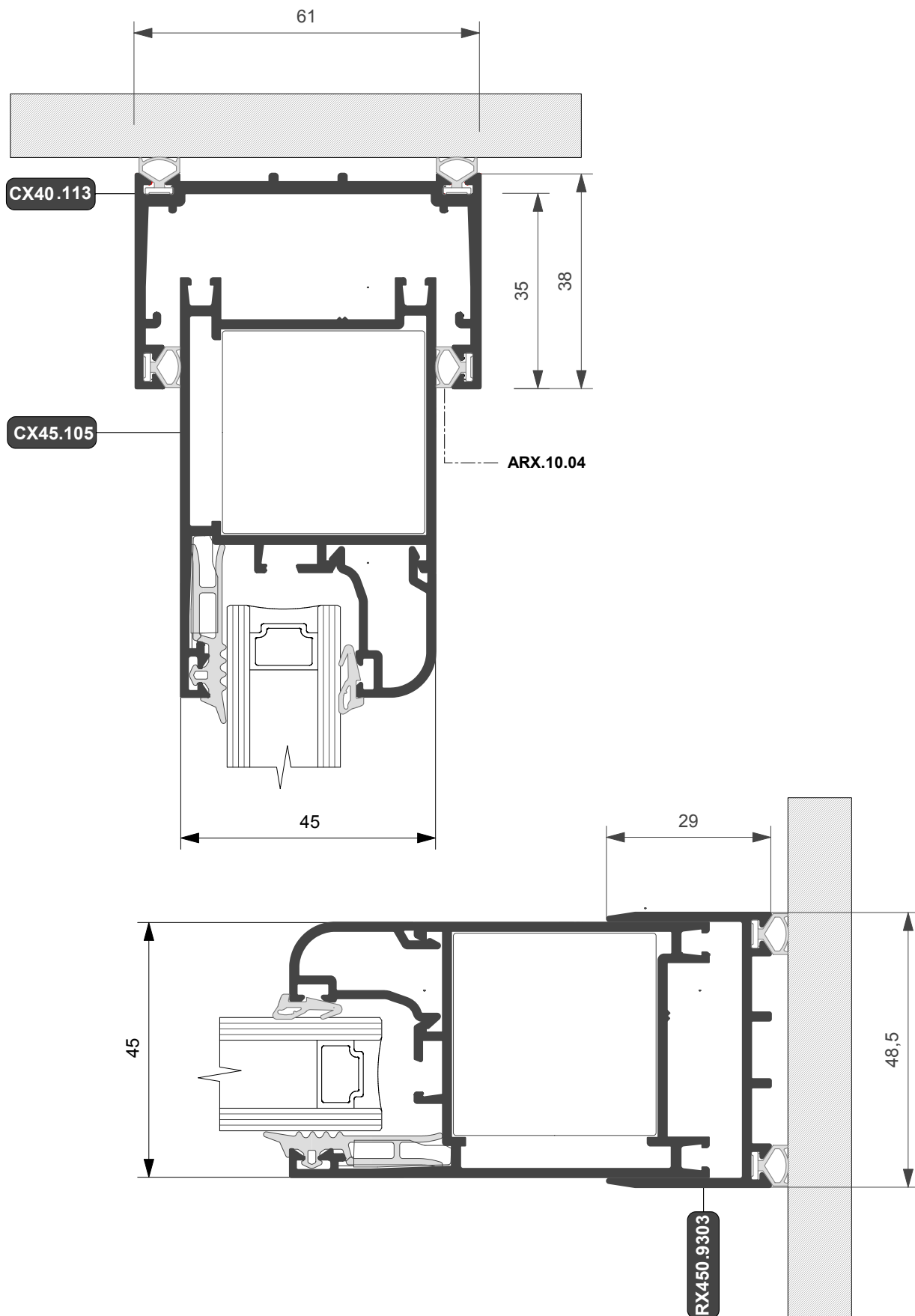

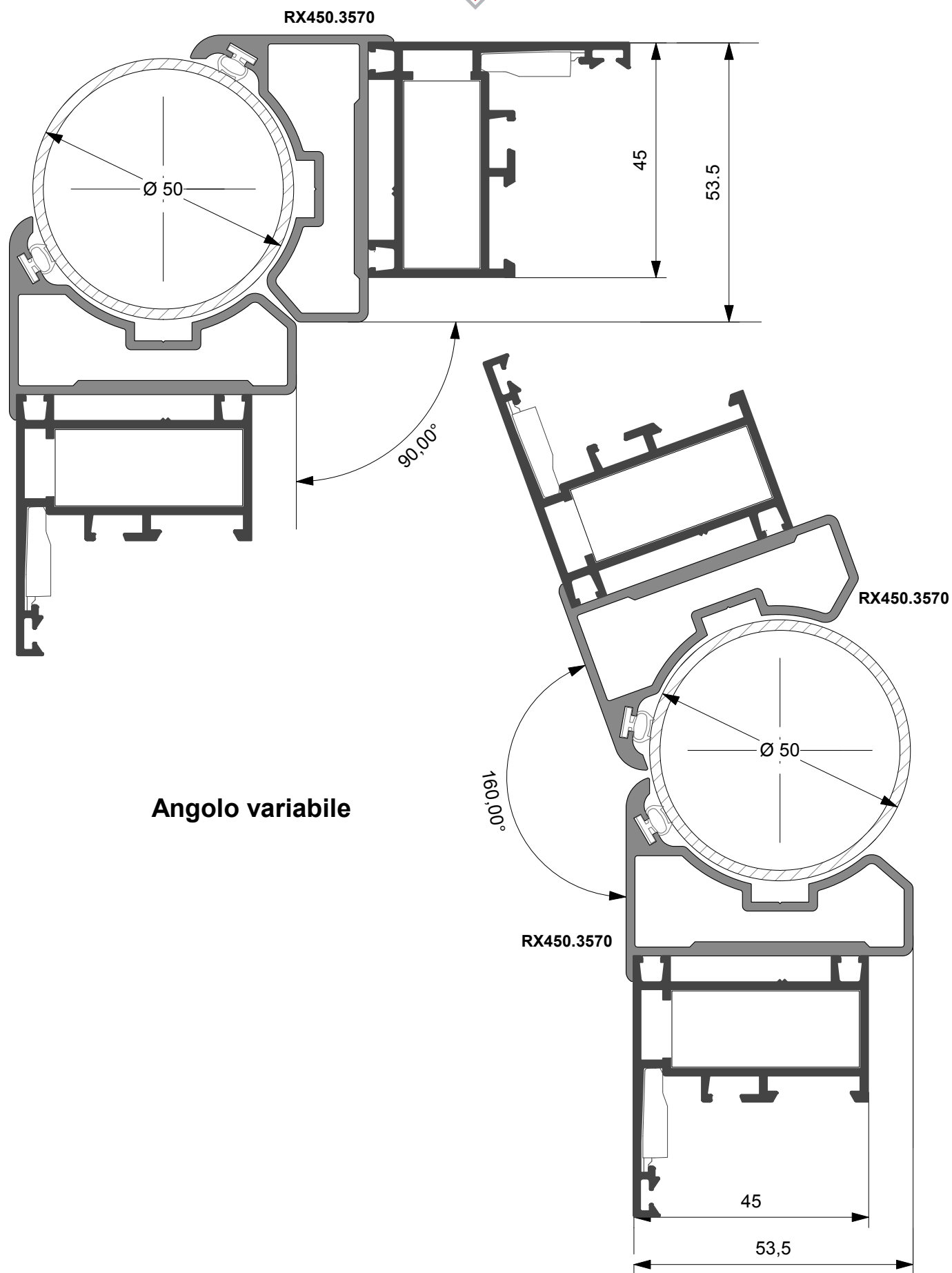

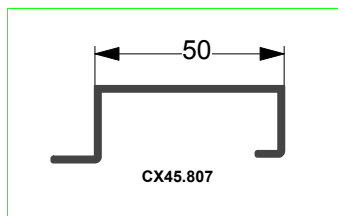

PORTA INTERNA

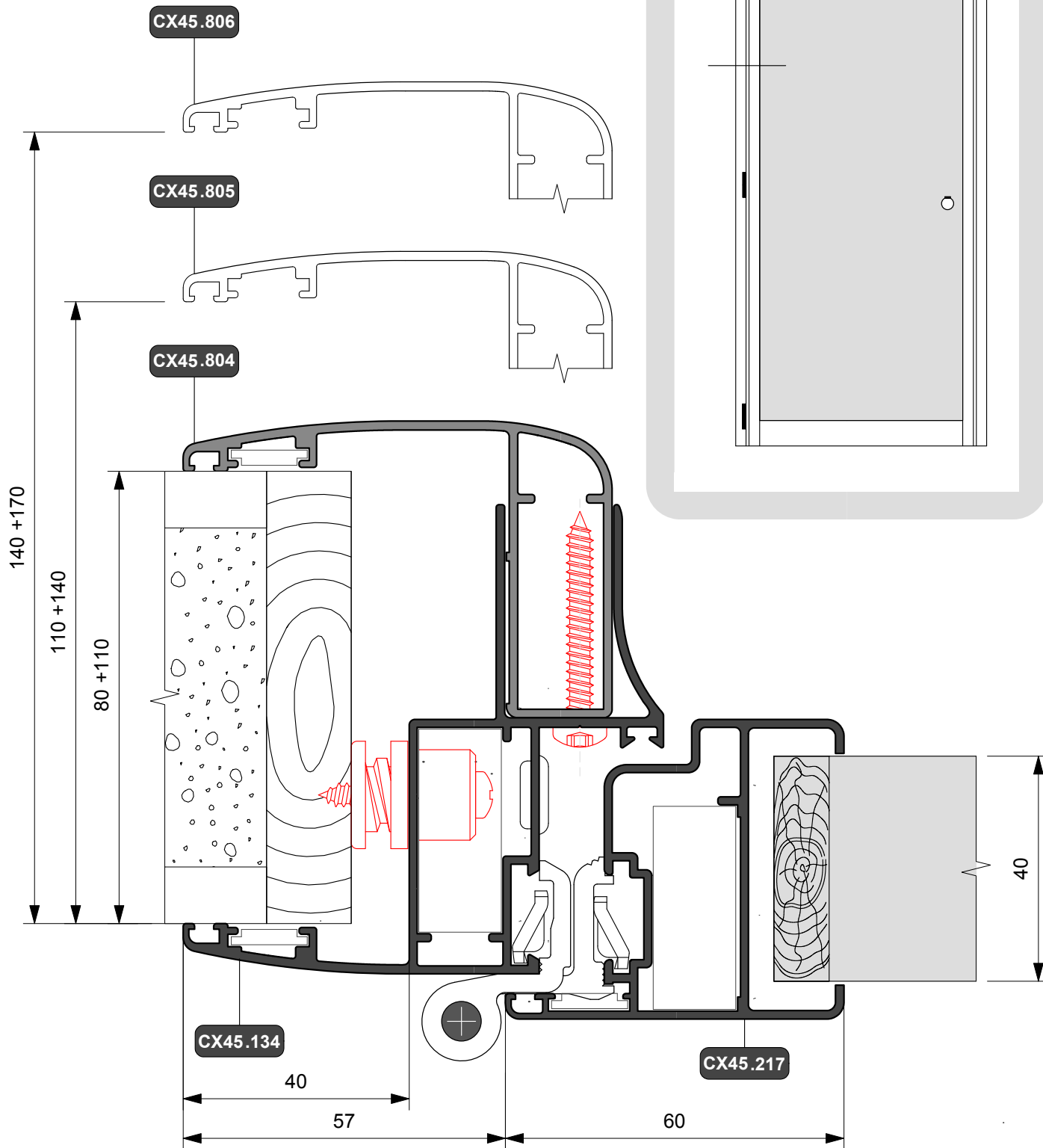
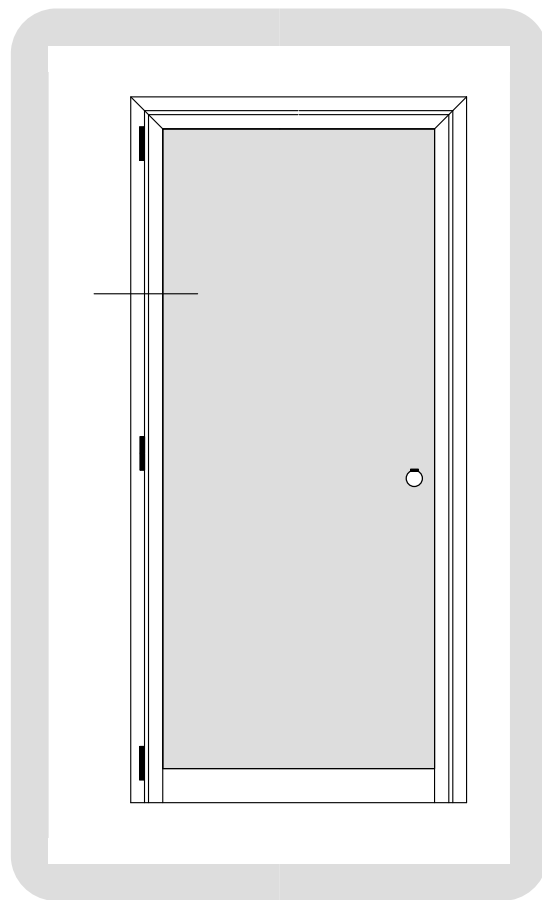

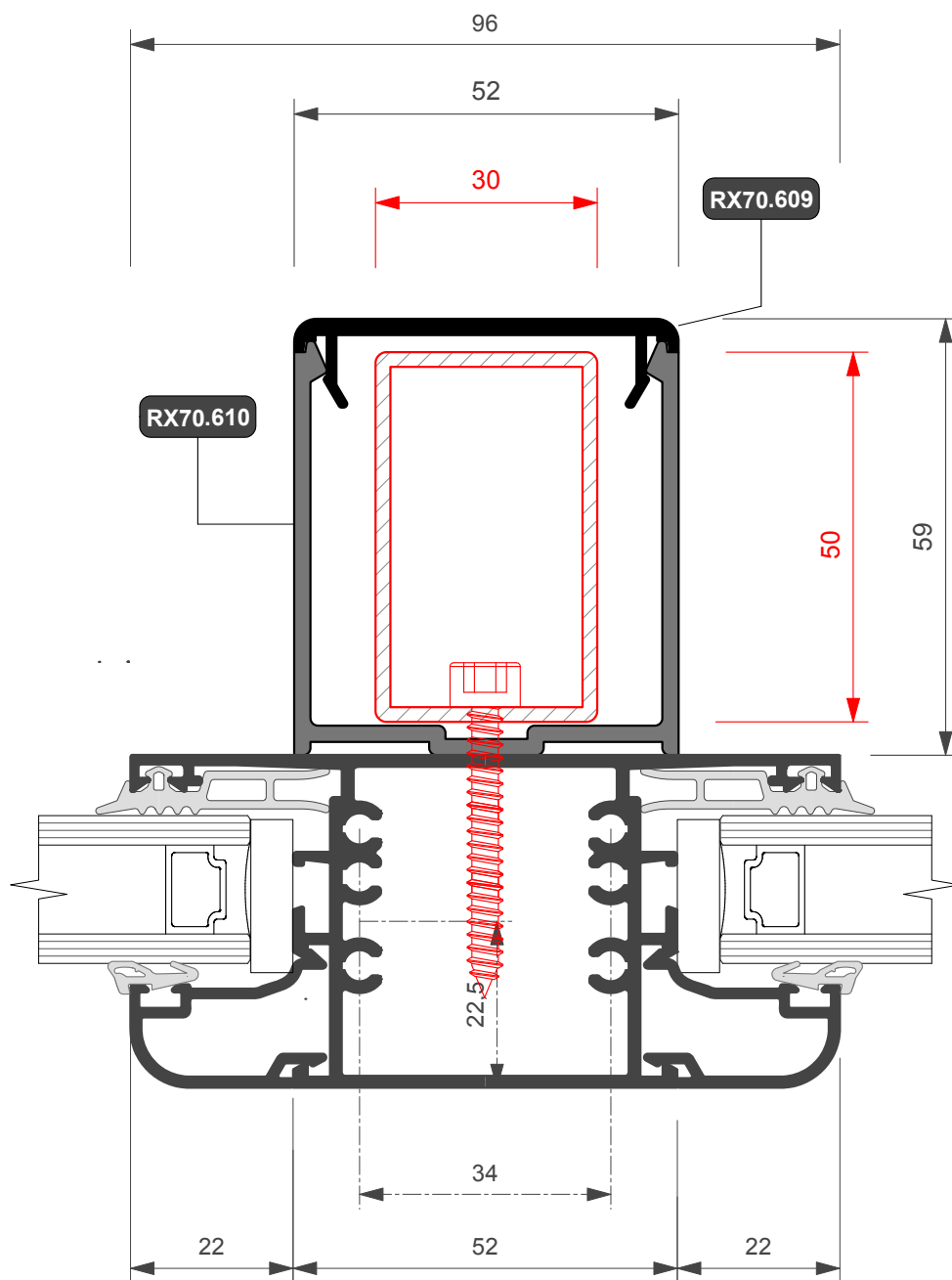

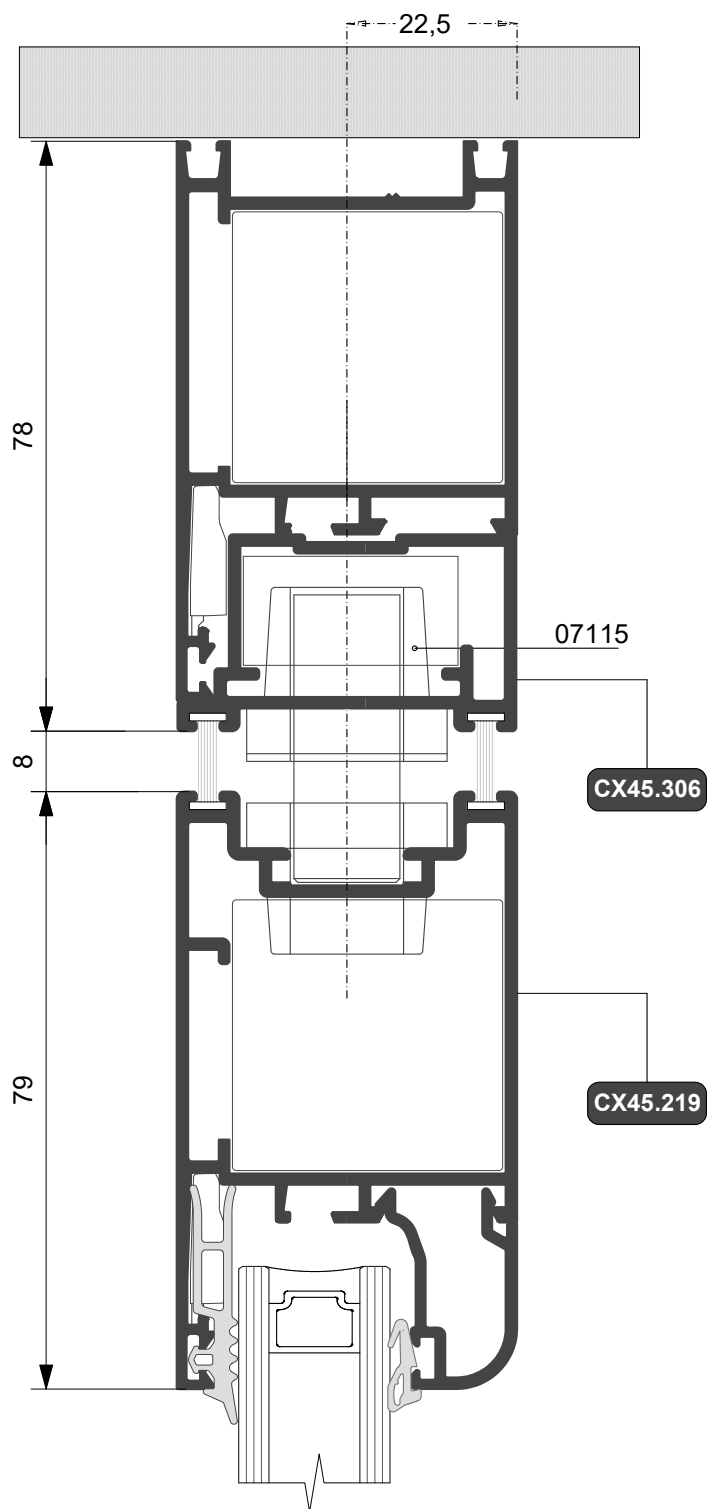

PORTE A VENTO

CARDINE E CHIUDIPIORTA -
PORTE VA E VIENI

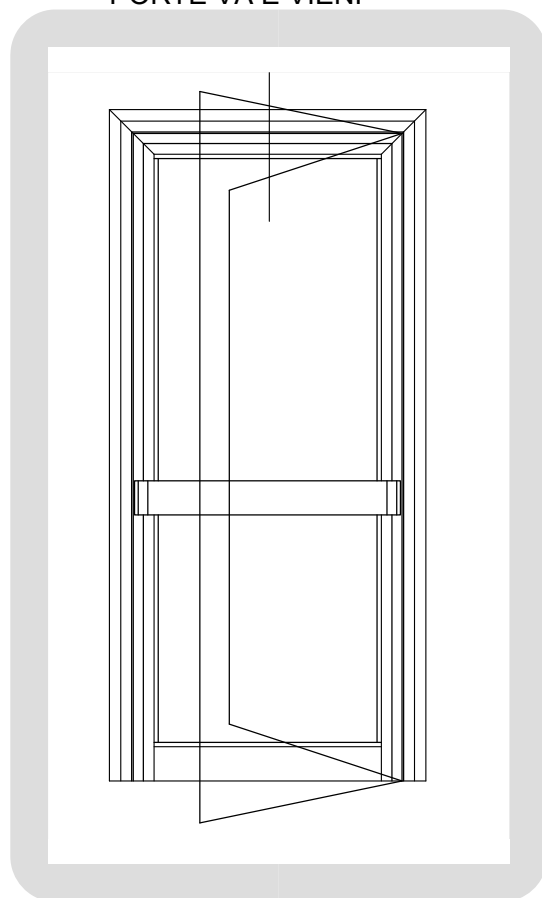



CARDINE E CHIUDIPIORTA - PORTE VA E VIENI
PORTE A VENTO

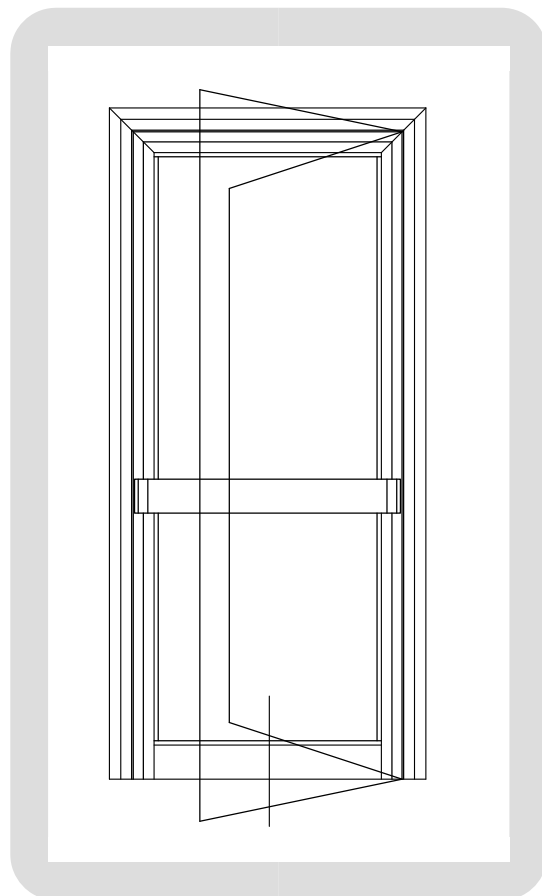
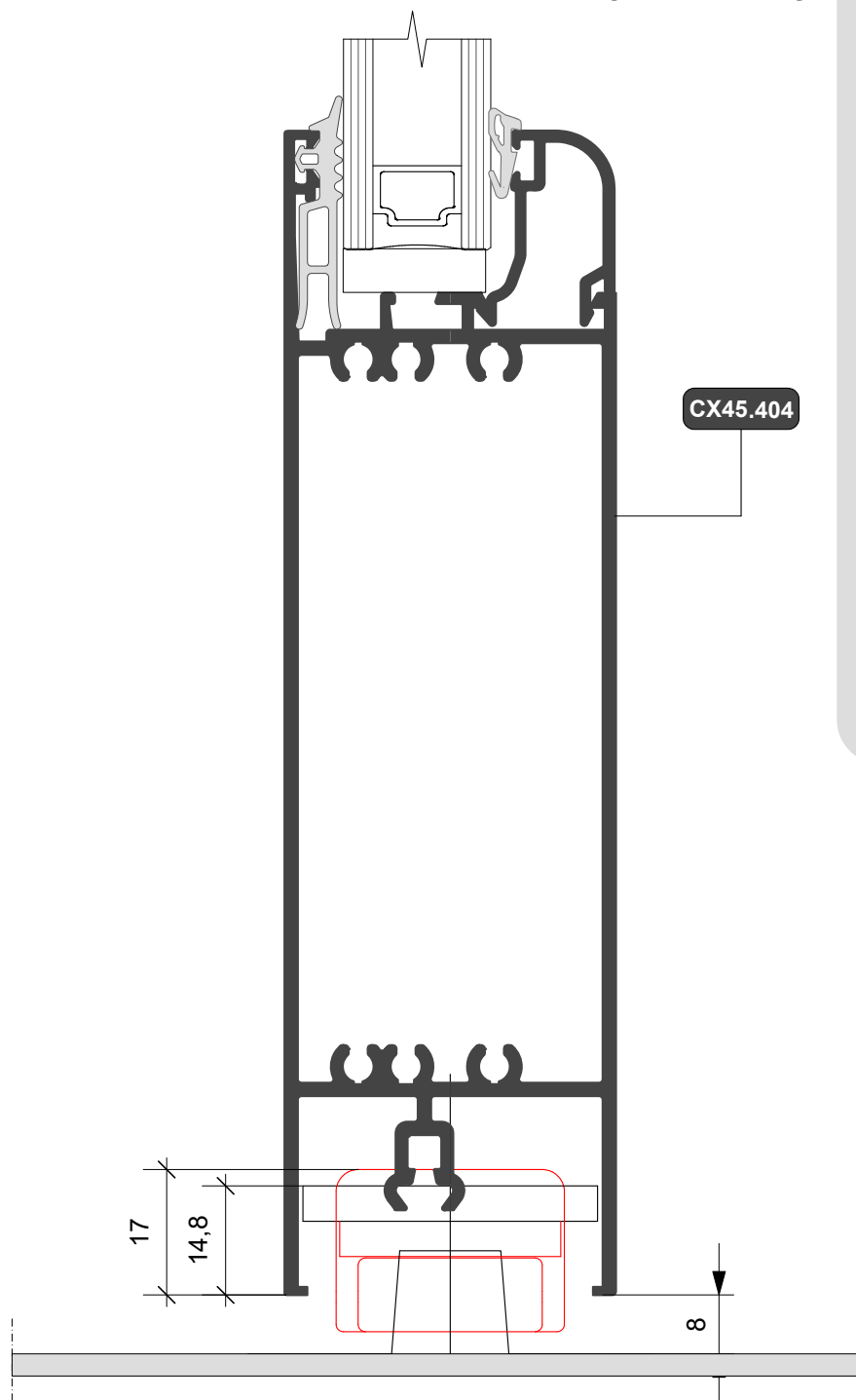

Chiudiporta a pavimento Art. 60220 - Art. 60221 (90°) - Art. 60222 (105°)

N.B. I CODICI INDICATI SONO RIFERITI A PRODOTTI DELLA CISA S.p.A.



PERSIANA (entrata 35.3 mm.)

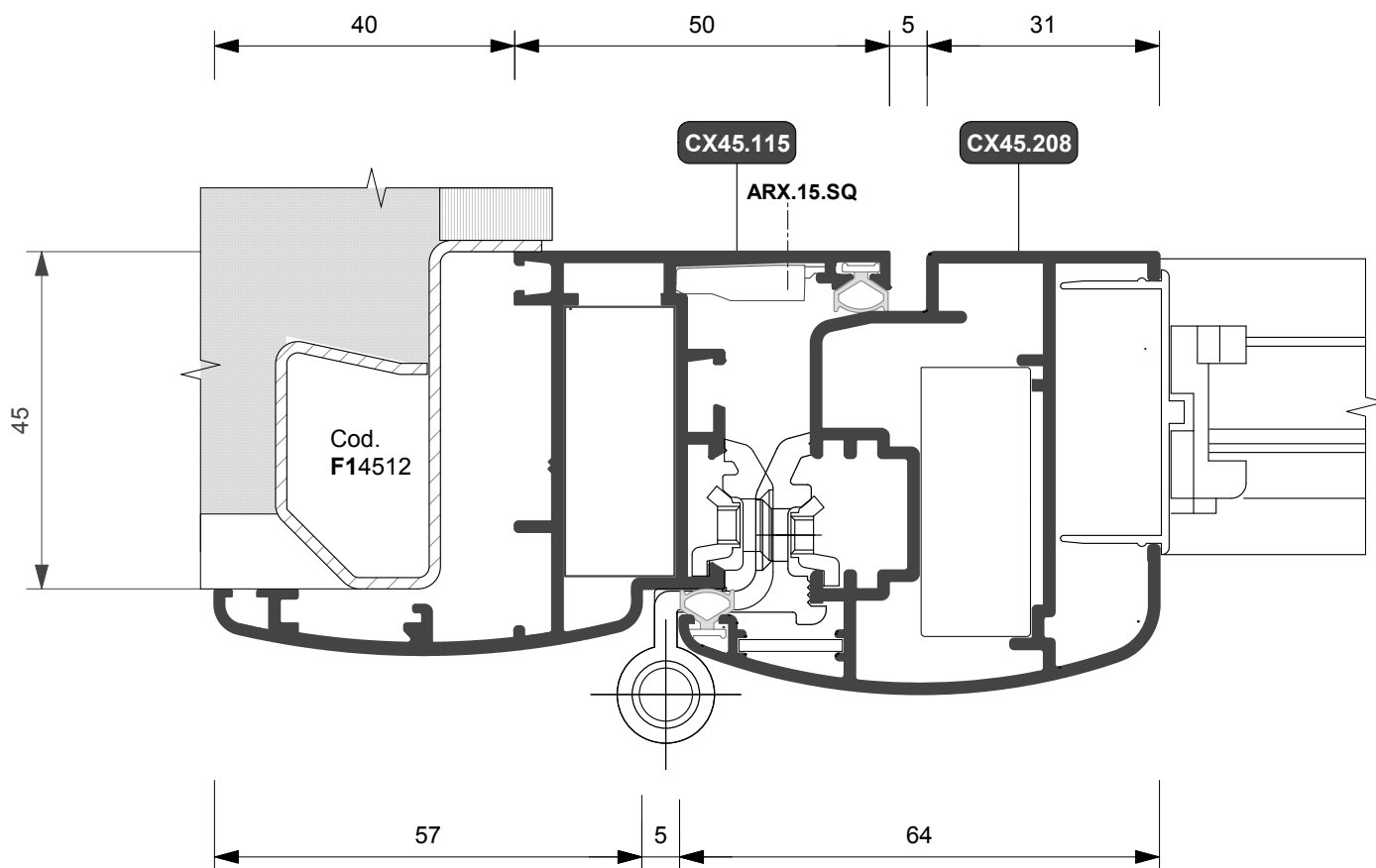
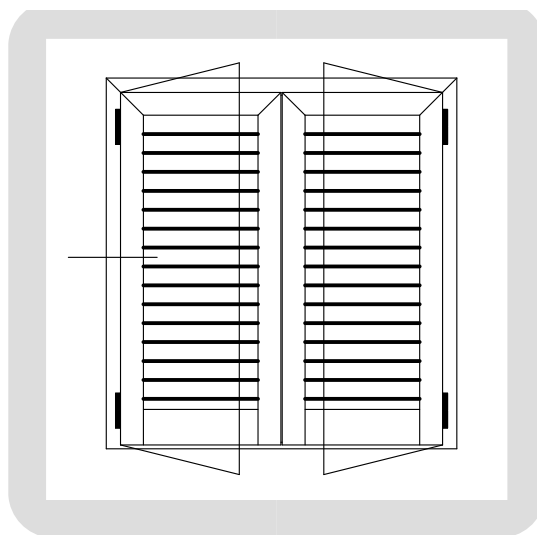



PERSIANA (entrata 35.3 mm.)

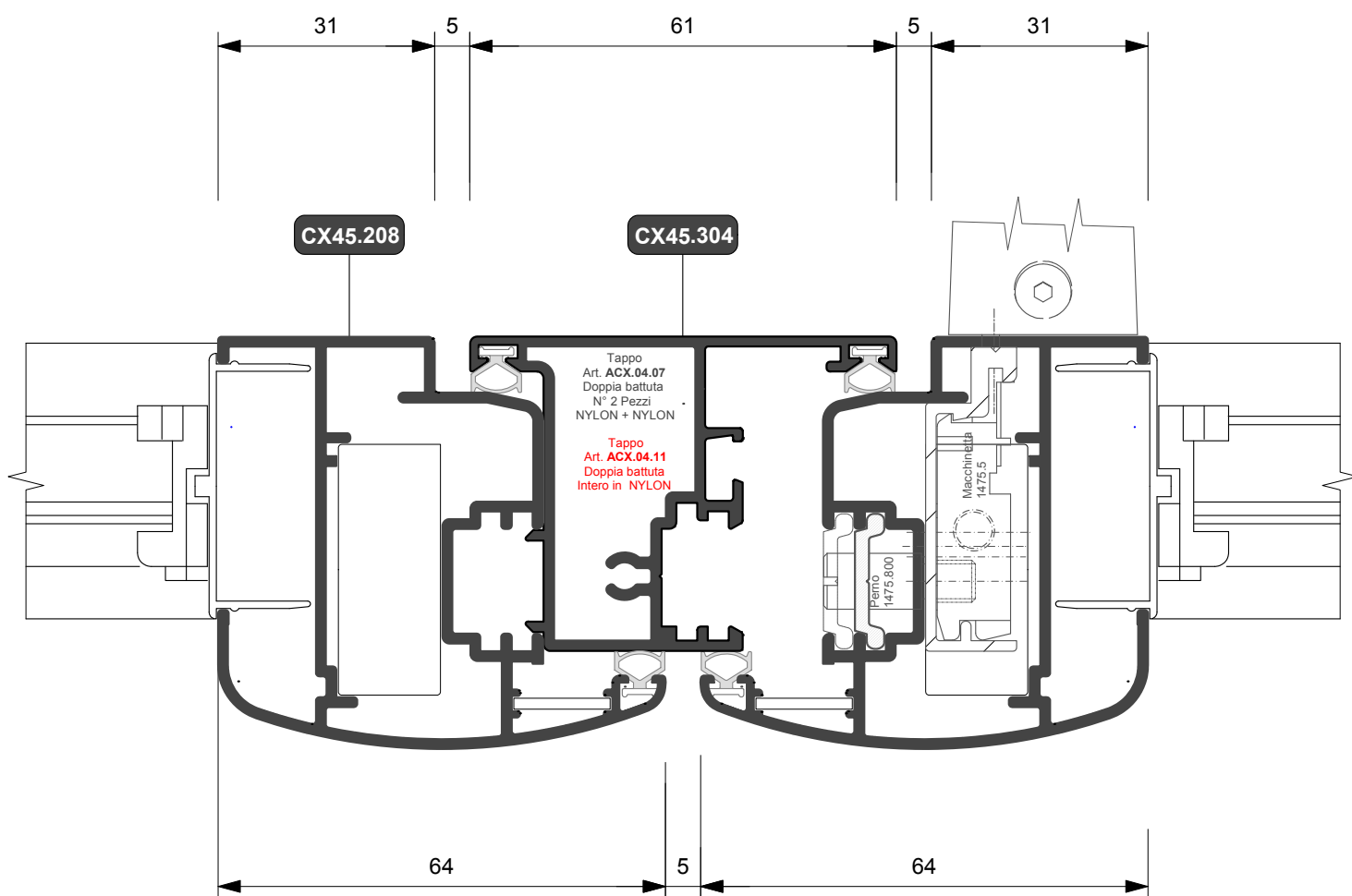
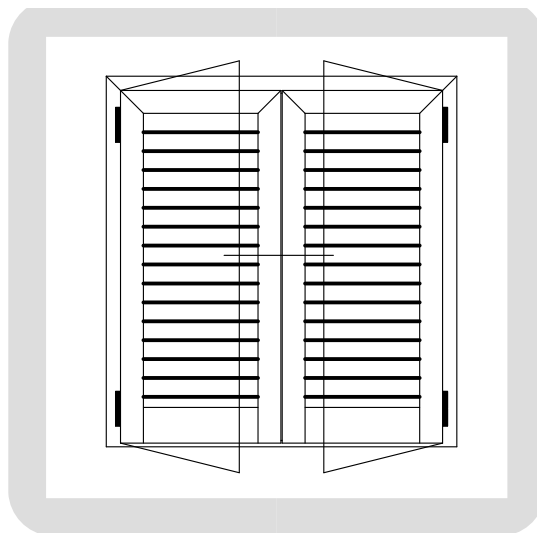



PERSIANA (entrata 35.3 mm.)

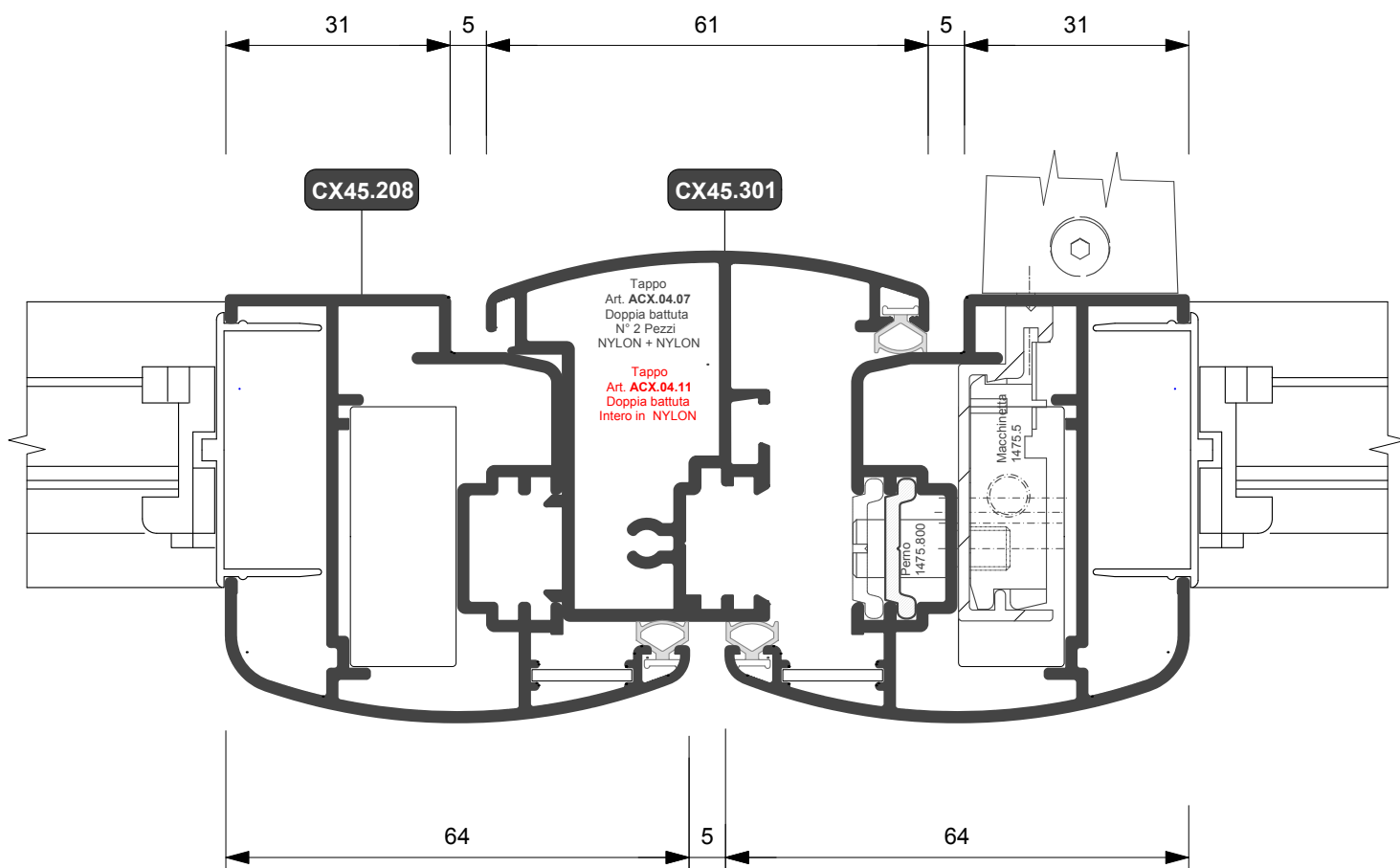
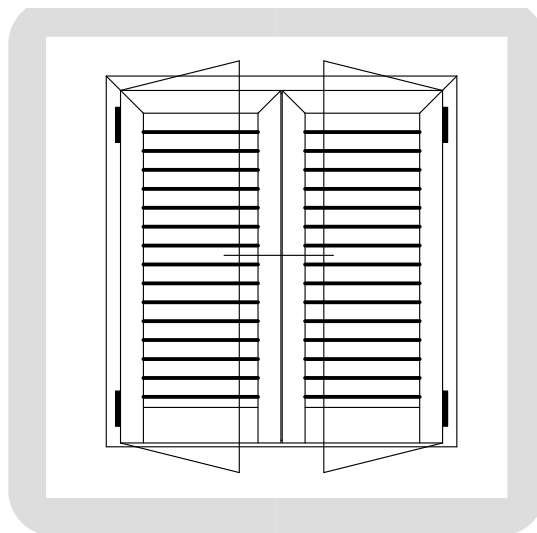

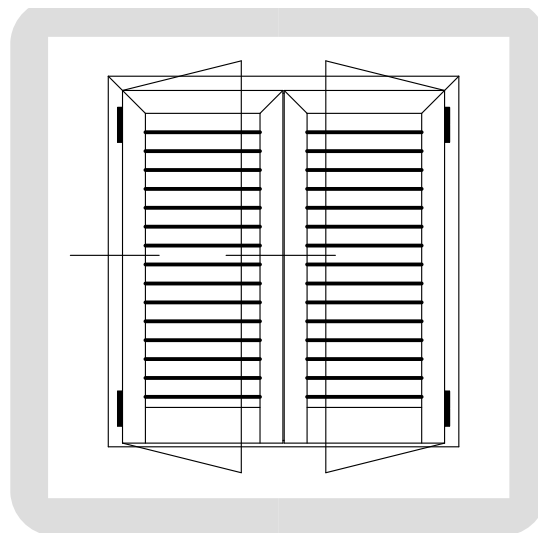
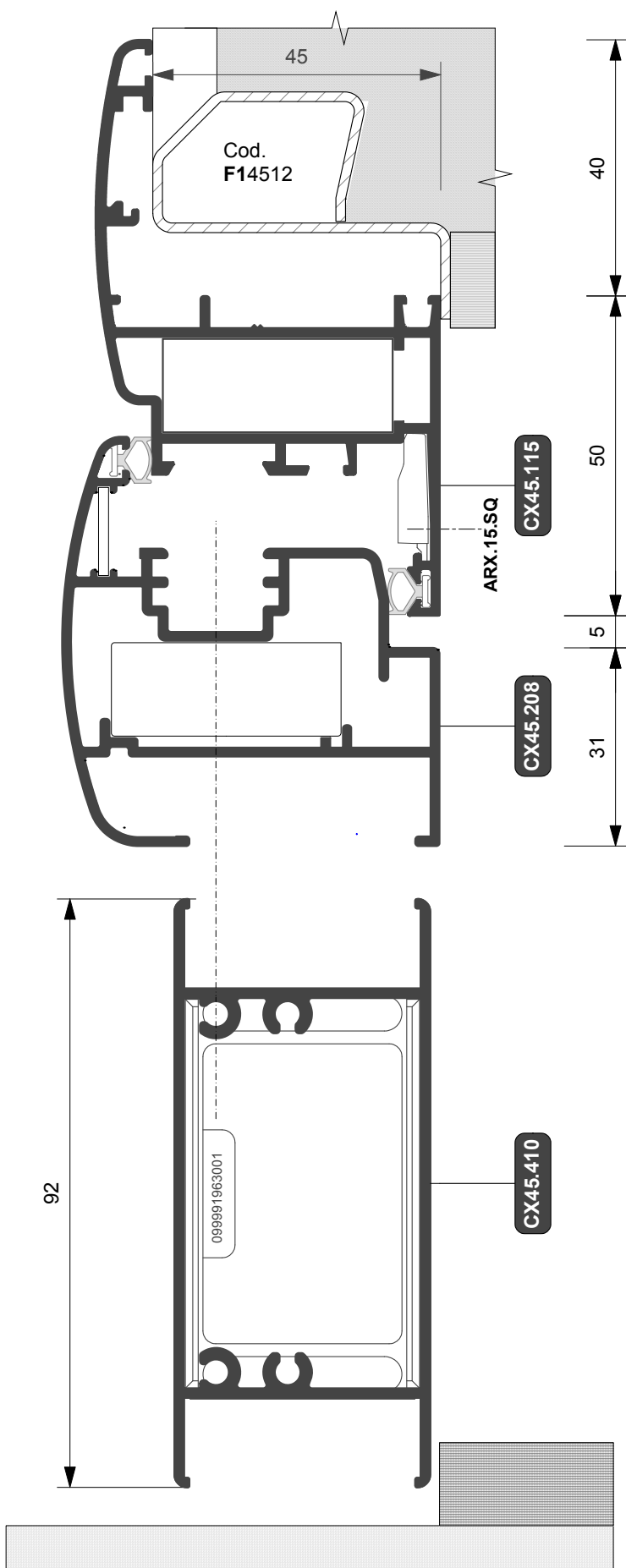

PERSIANA (entrata 35.3 mm.)

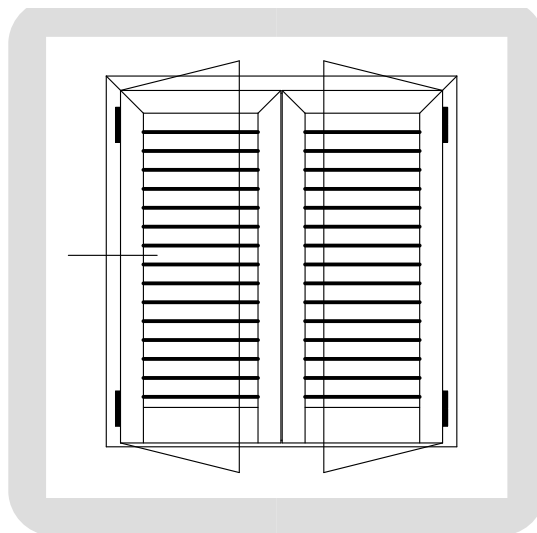

PERSIANA (entrata 25 mm.)

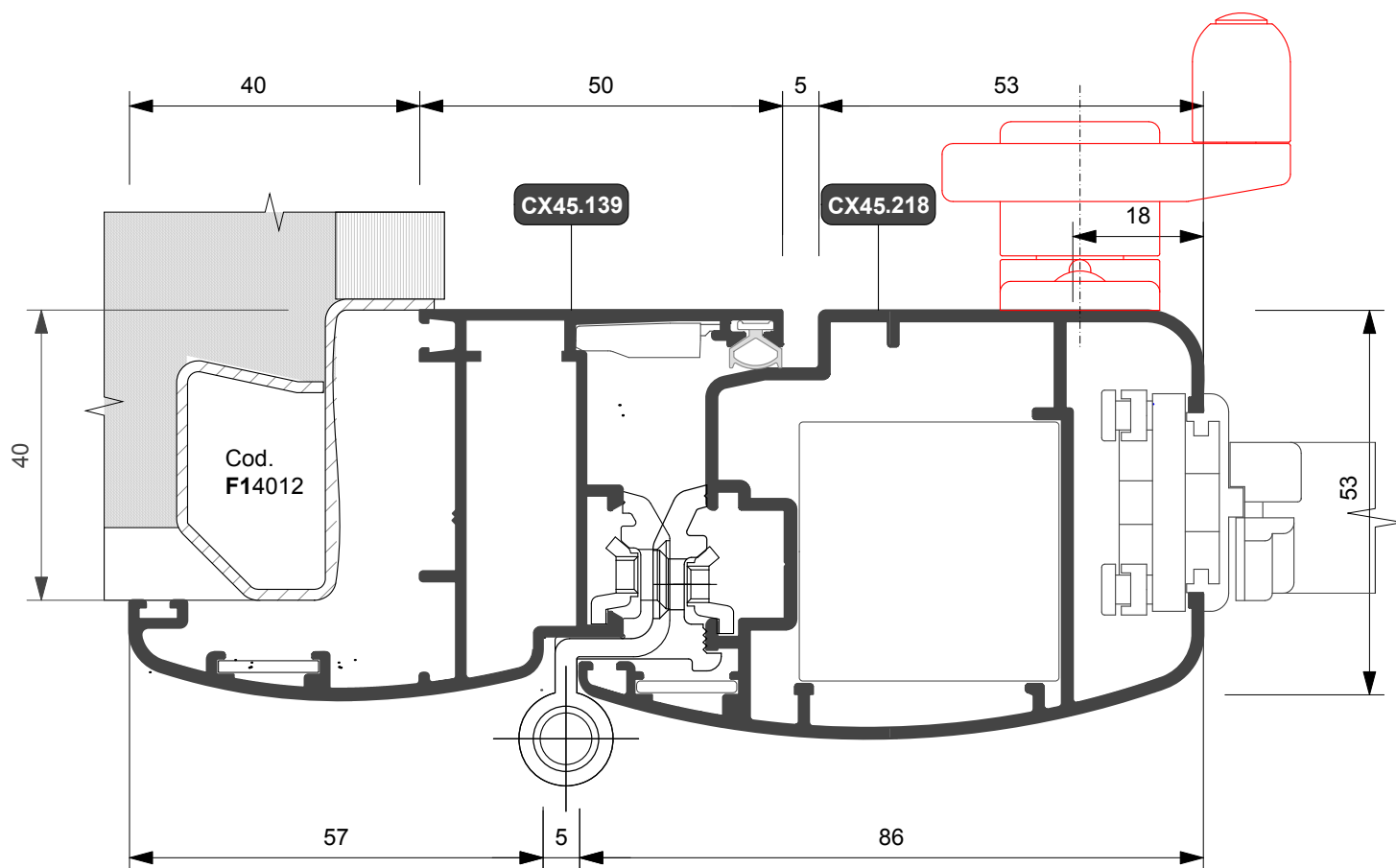

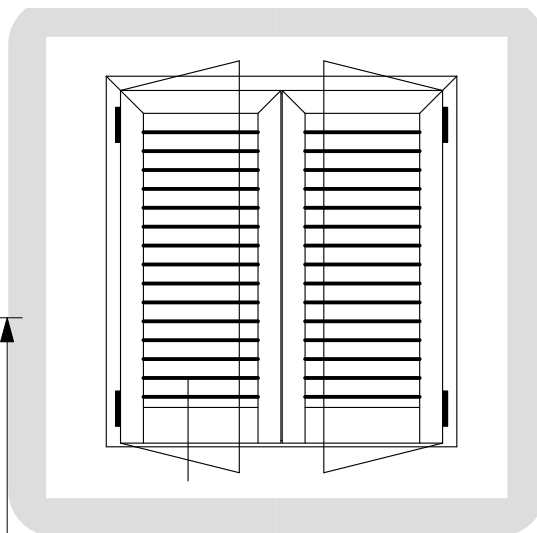
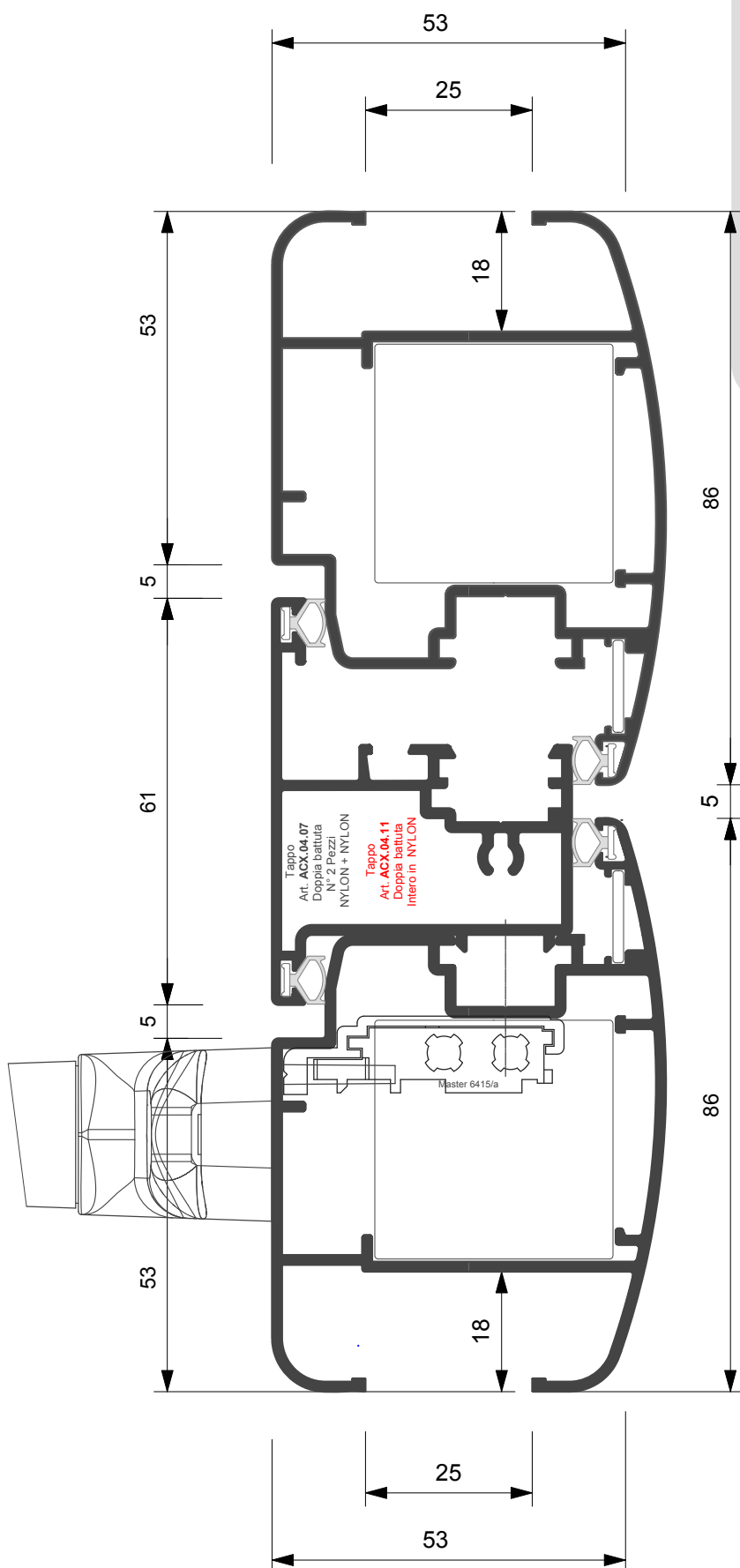

PERSIANA (entrata 25 mm.)

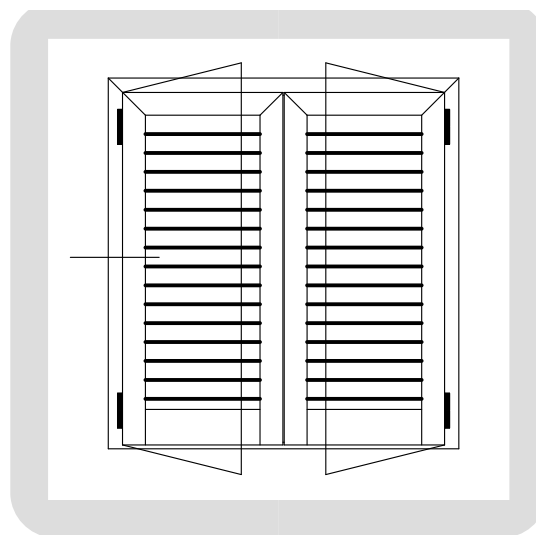
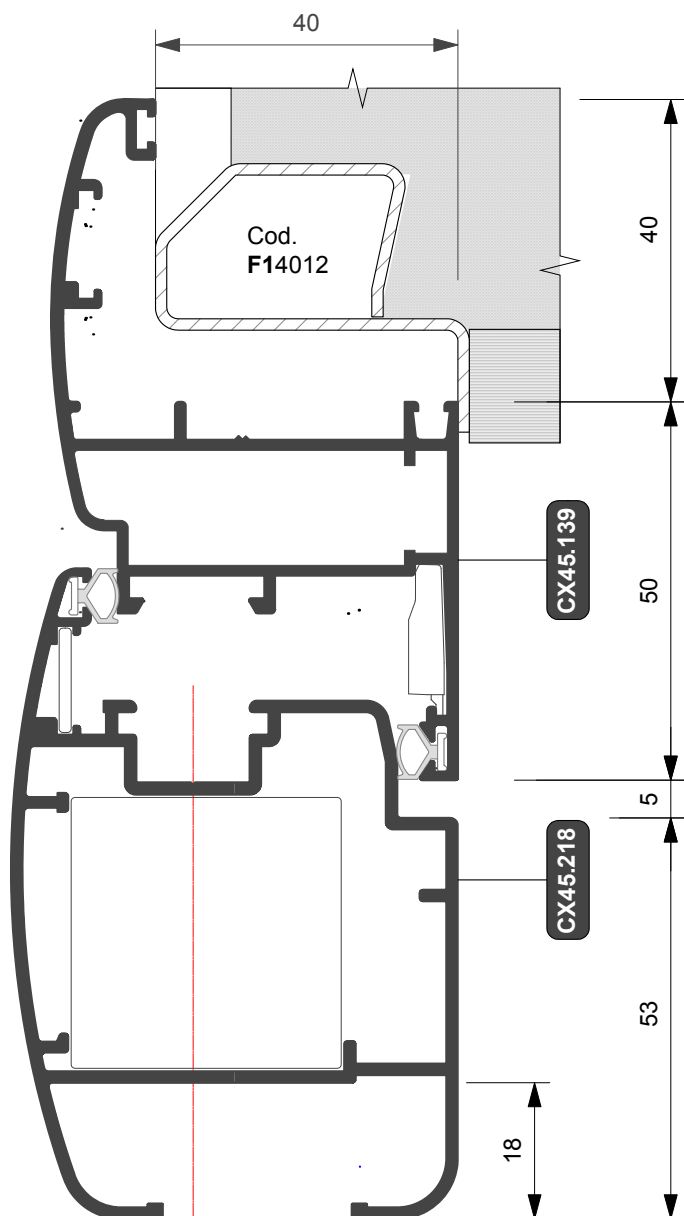

PERSIANA (entrata 25 mm.)

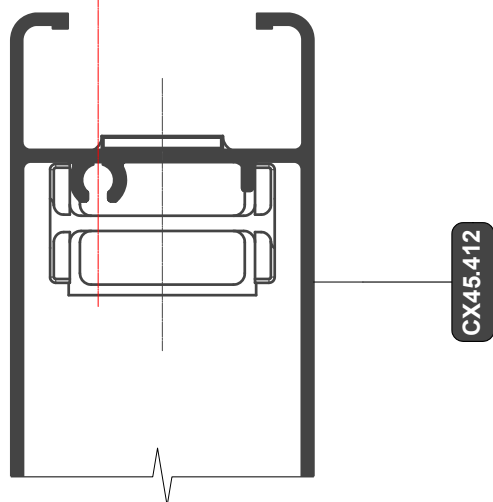

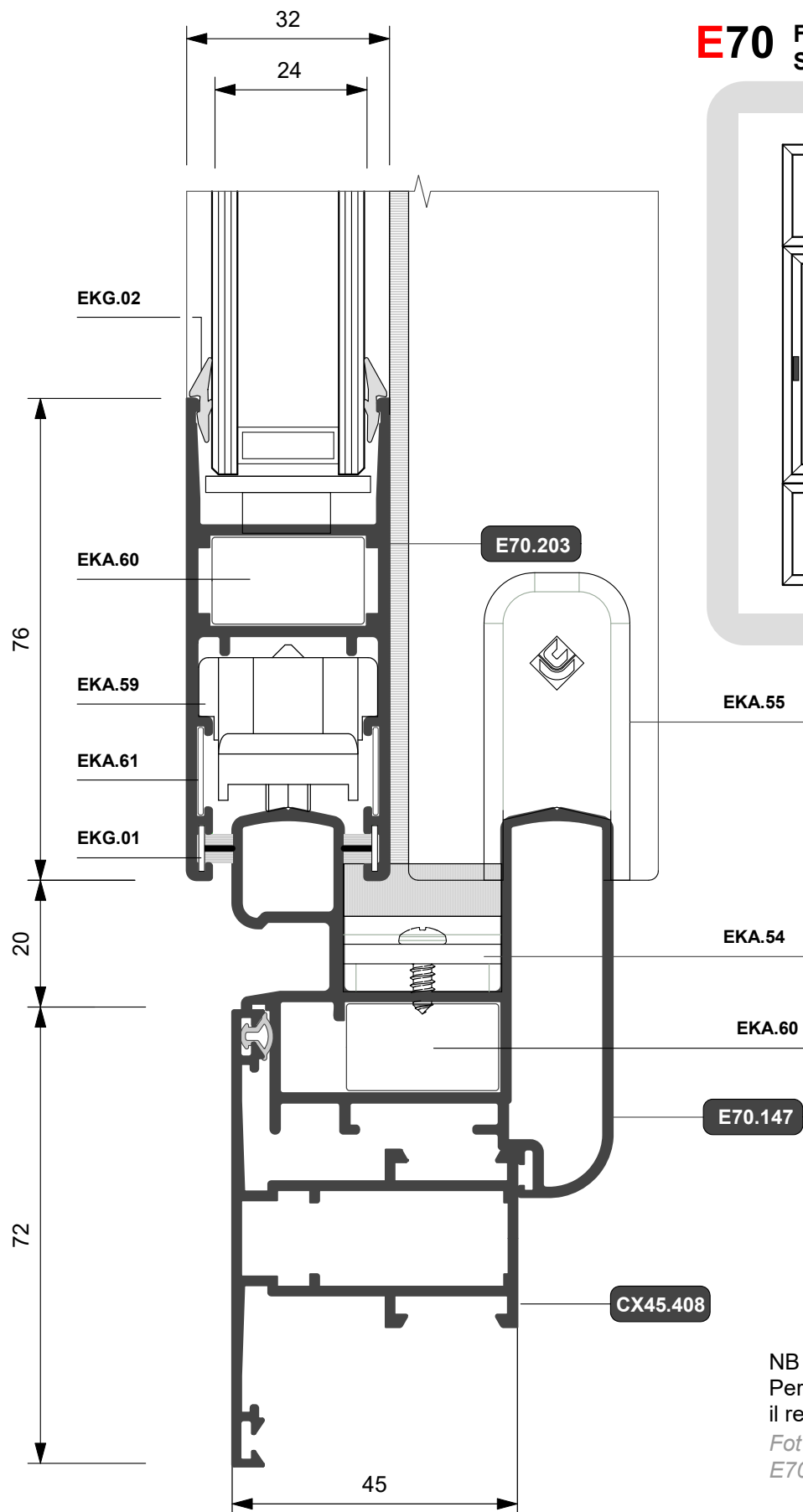

E70 **FINESTRA** **ABBINAMENTO**
SCORREVOLE **CON CX 450**

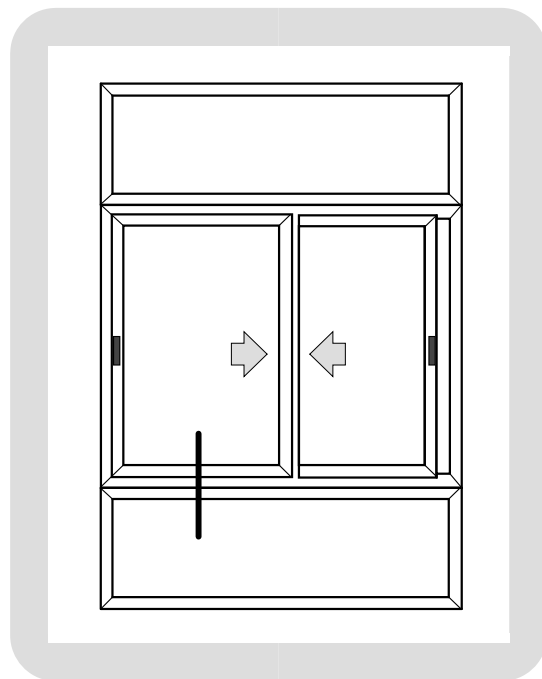

NB
Per maggiori dettagli consultare
il relativo catalogo scorrevole.
*For More info please refer to
E700 Catalogue for Sliding Windows*



Linea **elite**

FINESTRA VETRO INFILARE
(entrata 25 mm.)

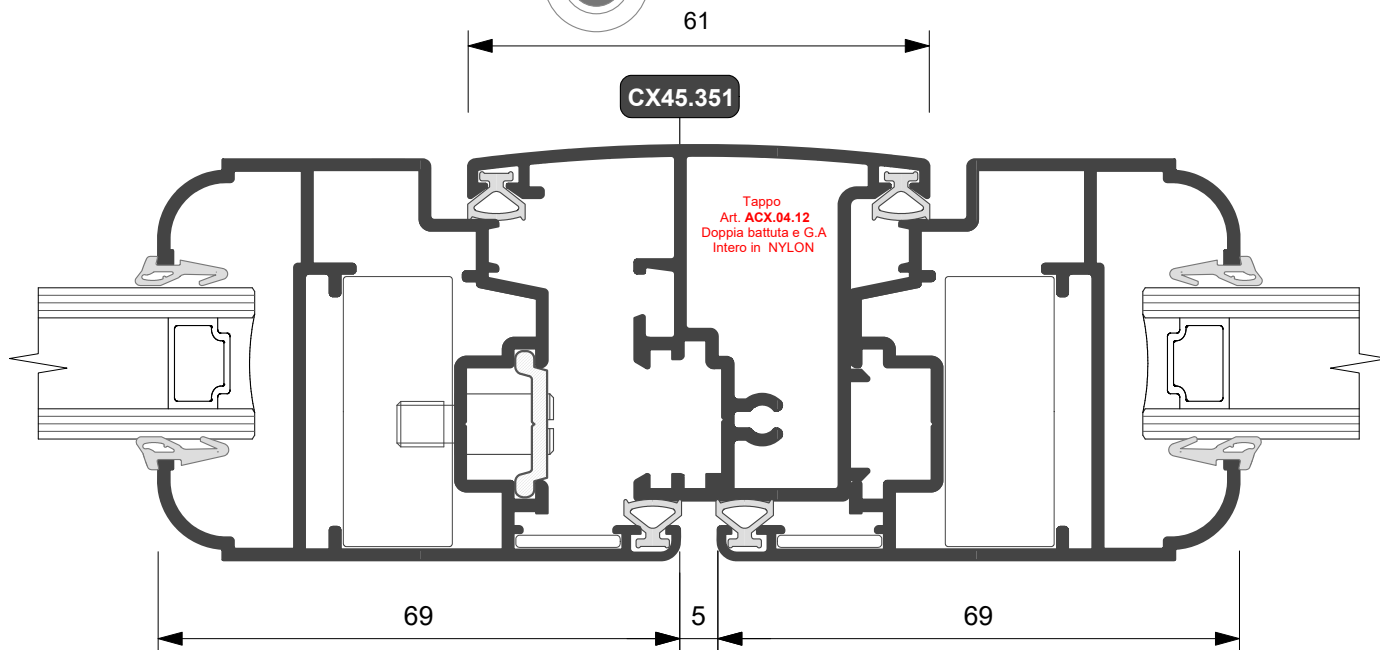
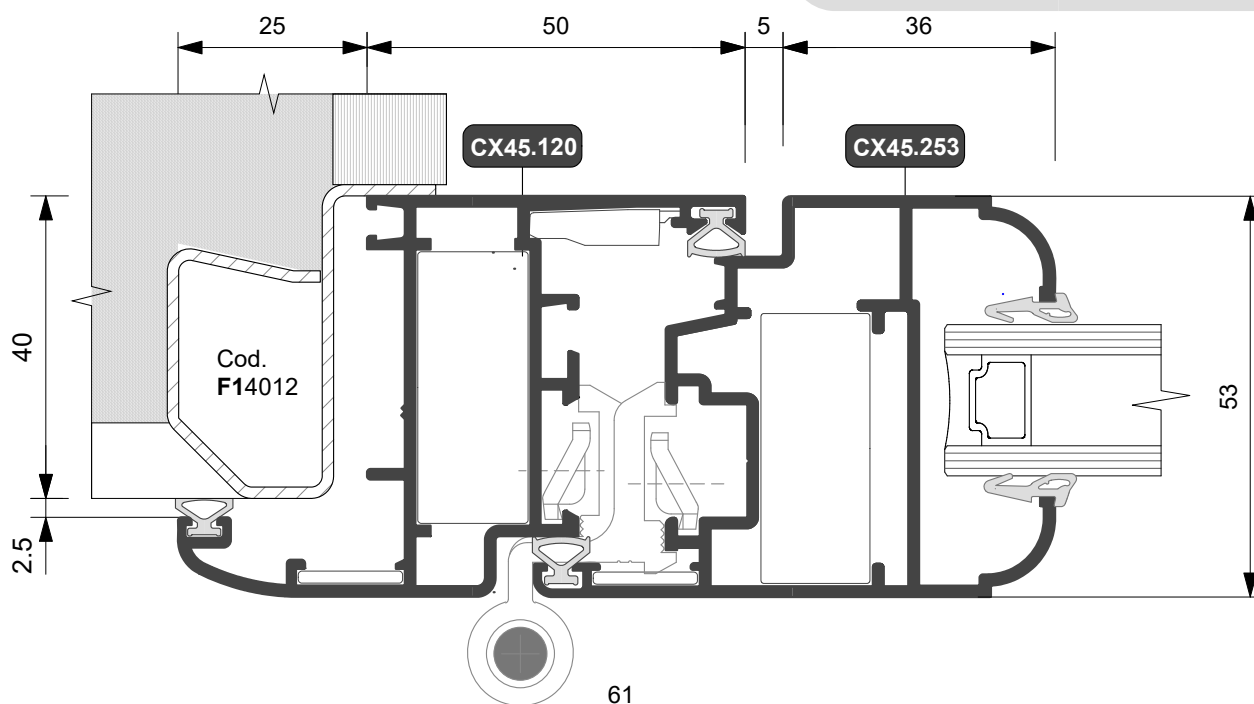
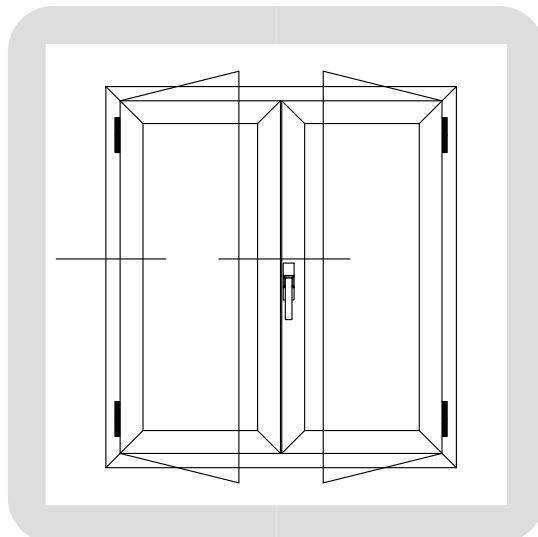



Linea **elite**

PERSIANA (entrata 25 mm.)

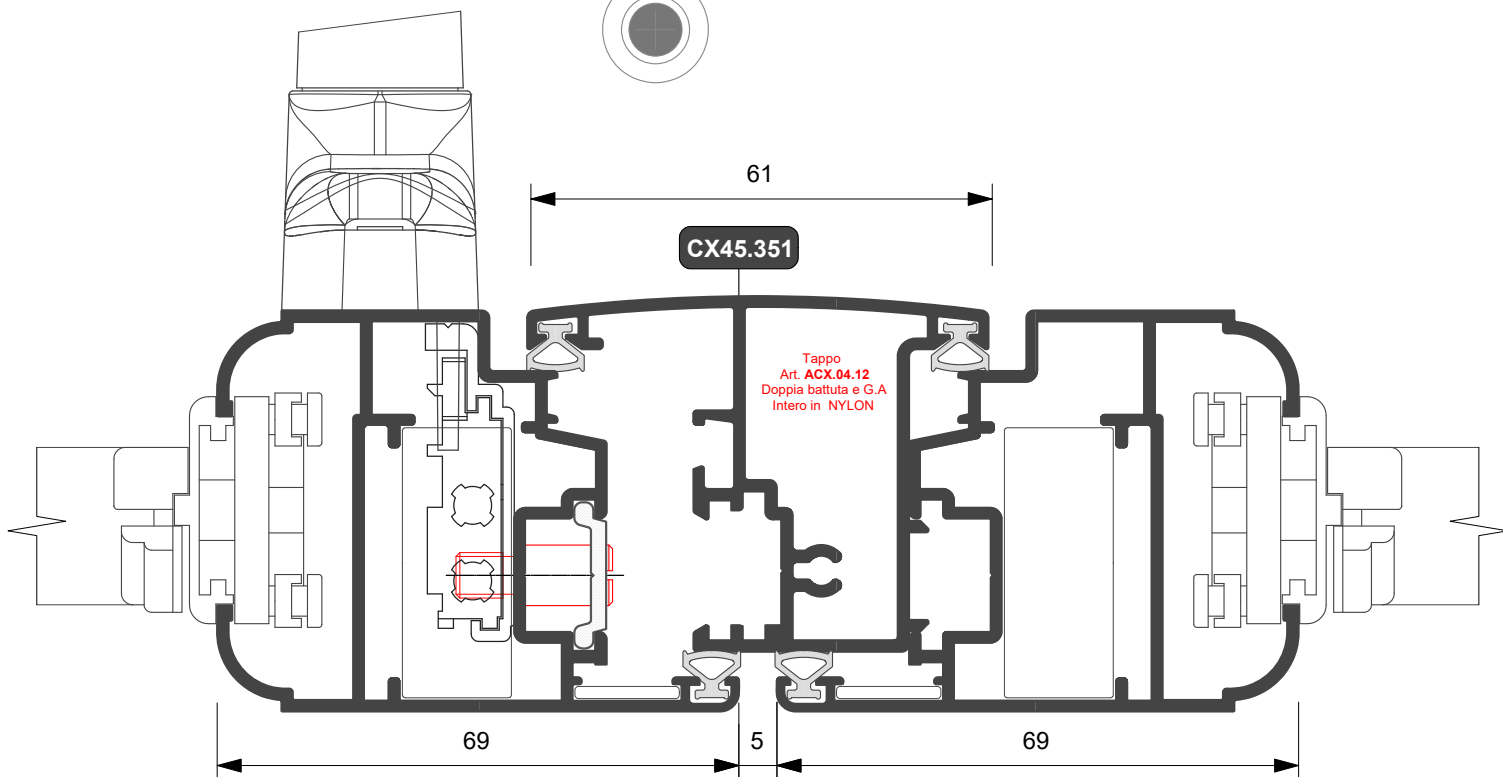
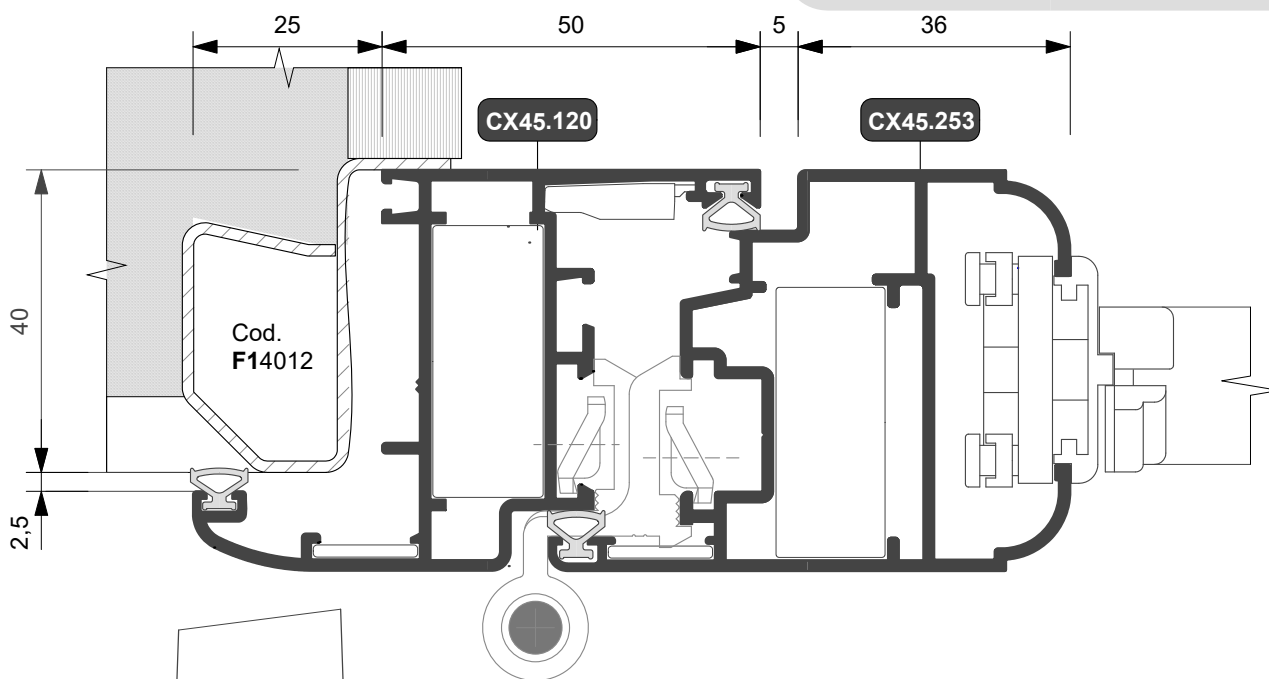
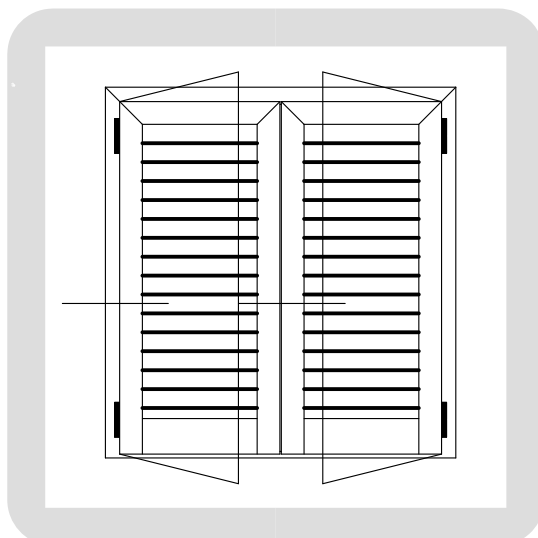



Linea



FINESTRA VETRO INFILARE
(entrata 25 mm.)

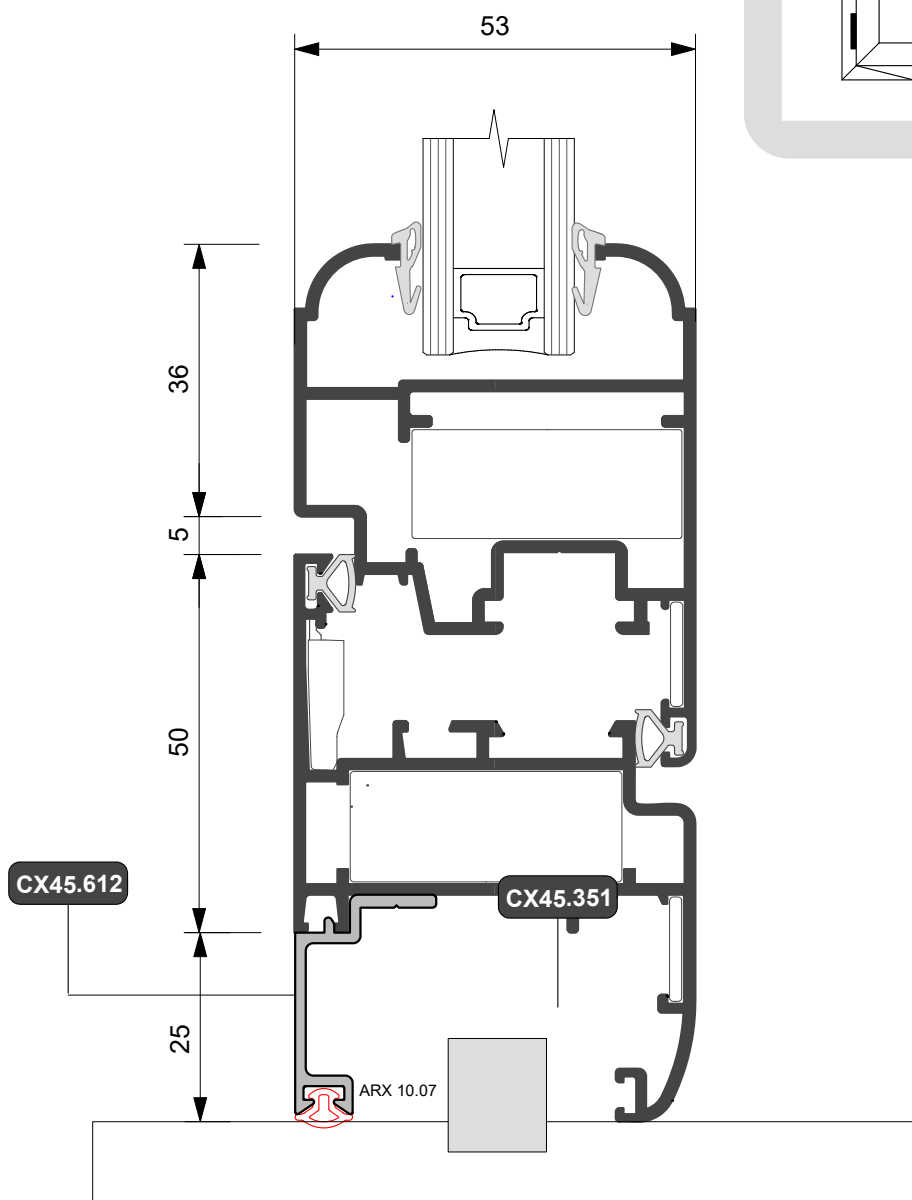
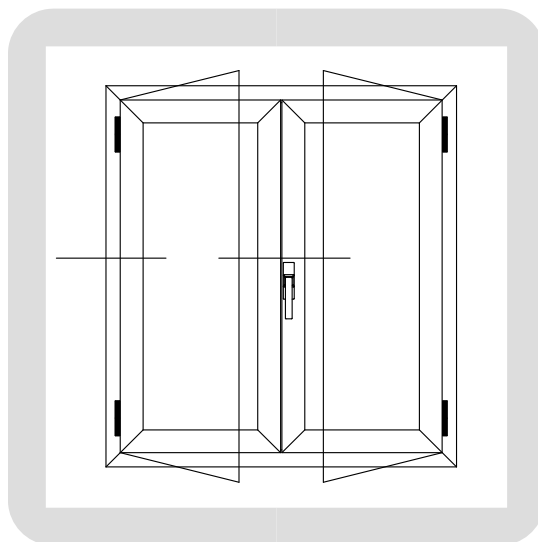



Linea



FINESTRA VETRO INFILARE
(entrata 25 mm.)

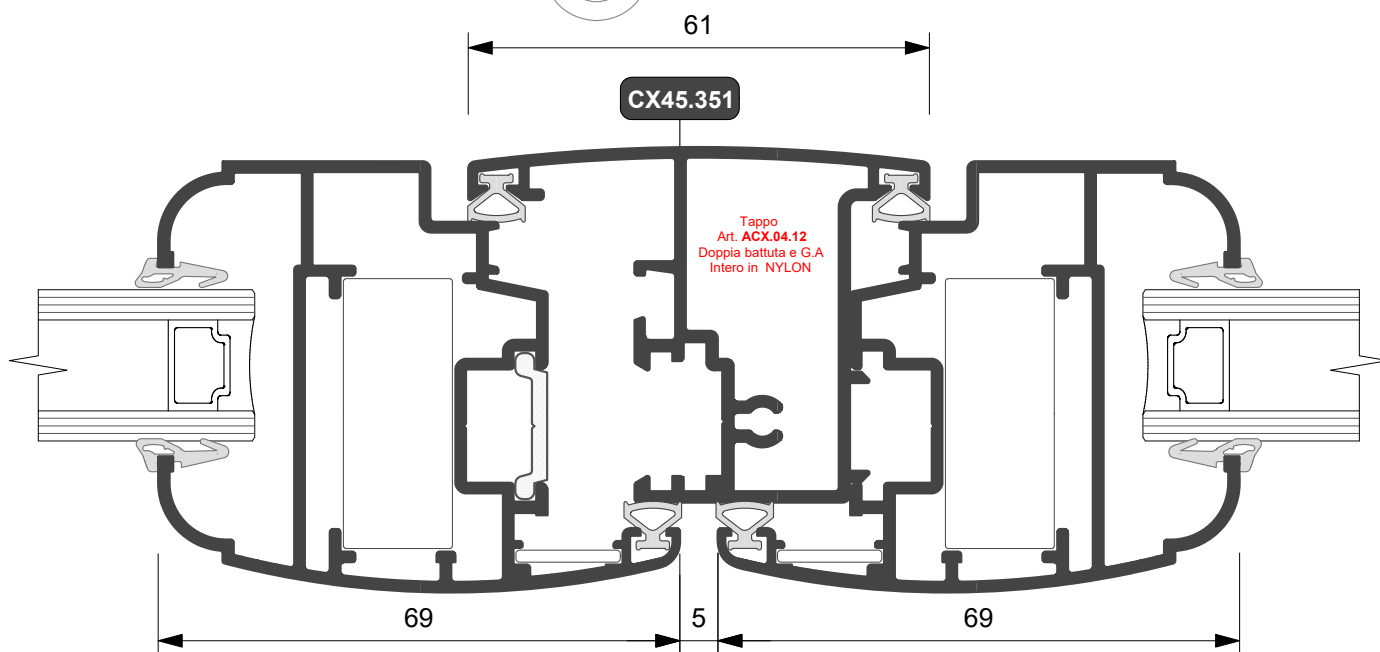
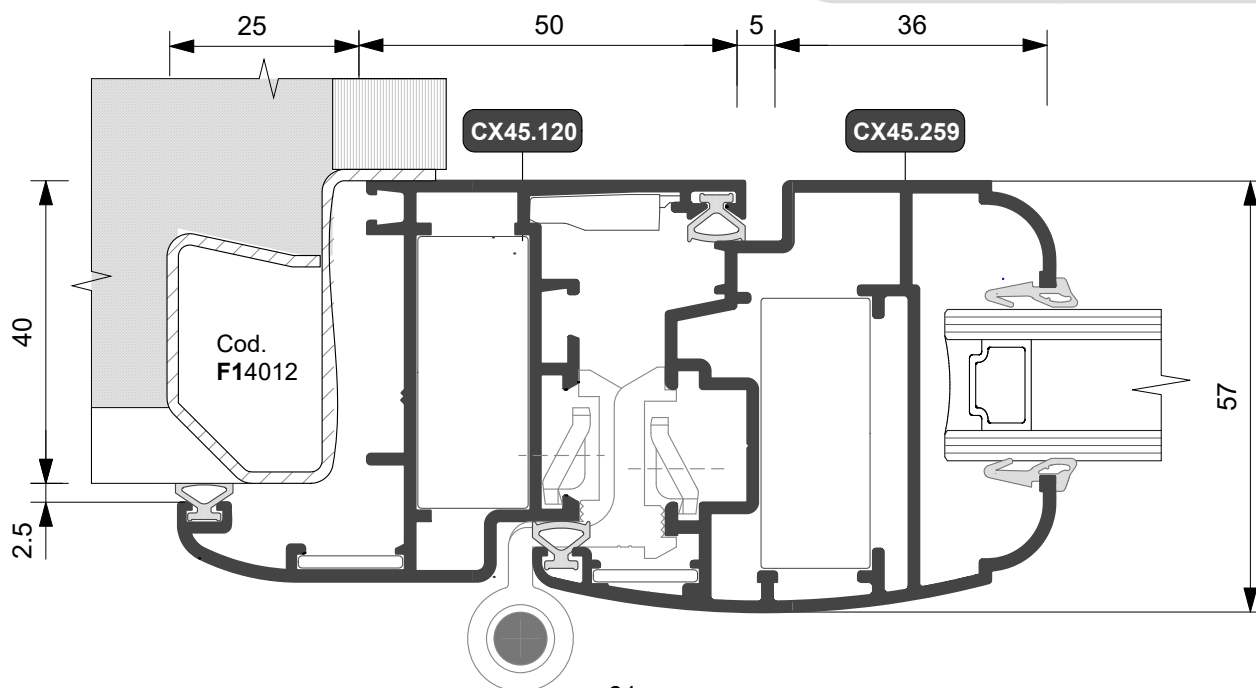
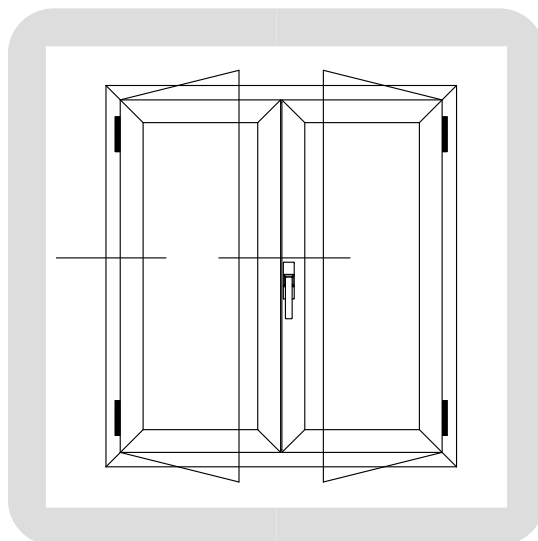



Linea **elite**

PERSIANA (entrata 25 mm.)

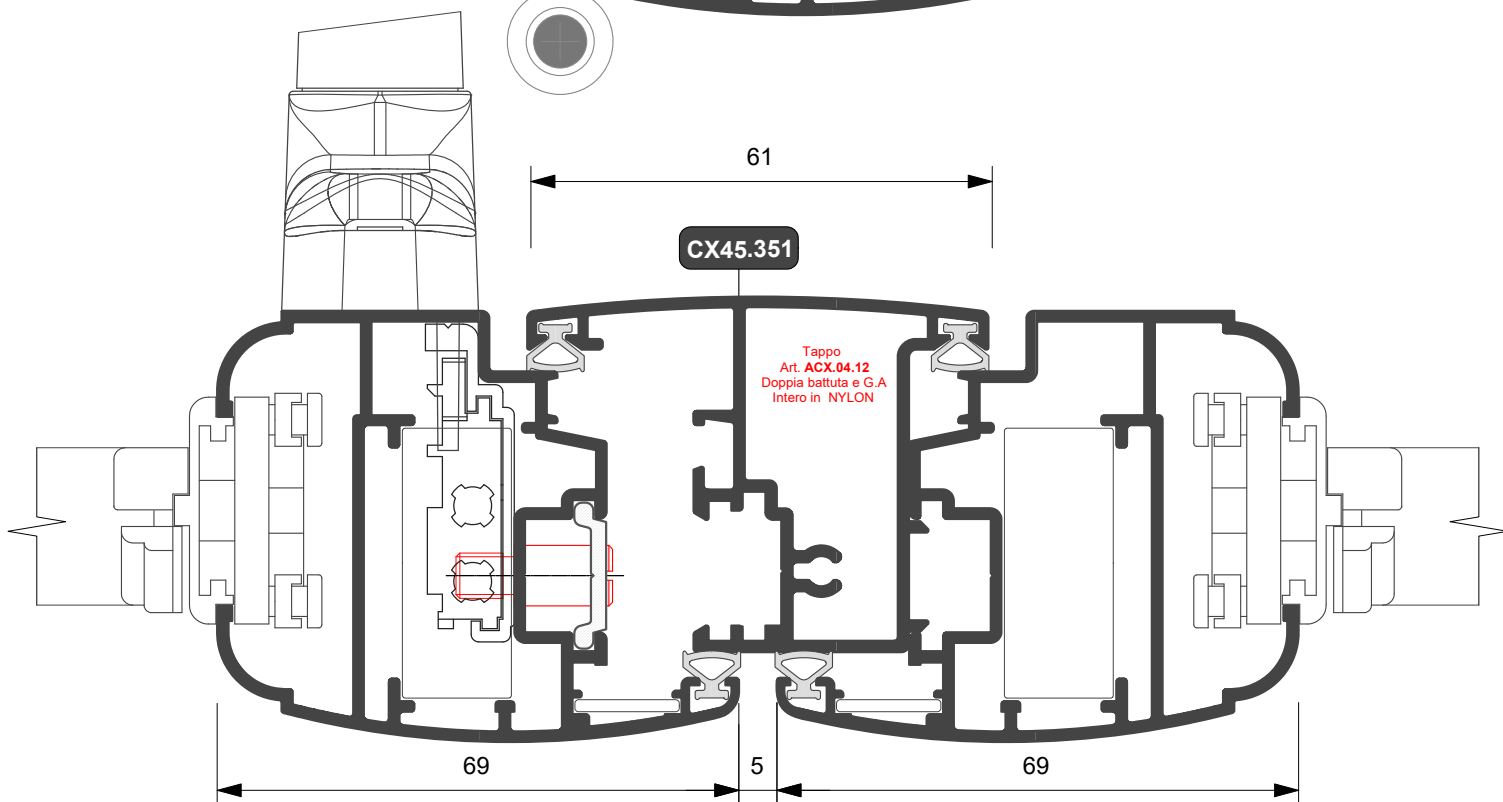
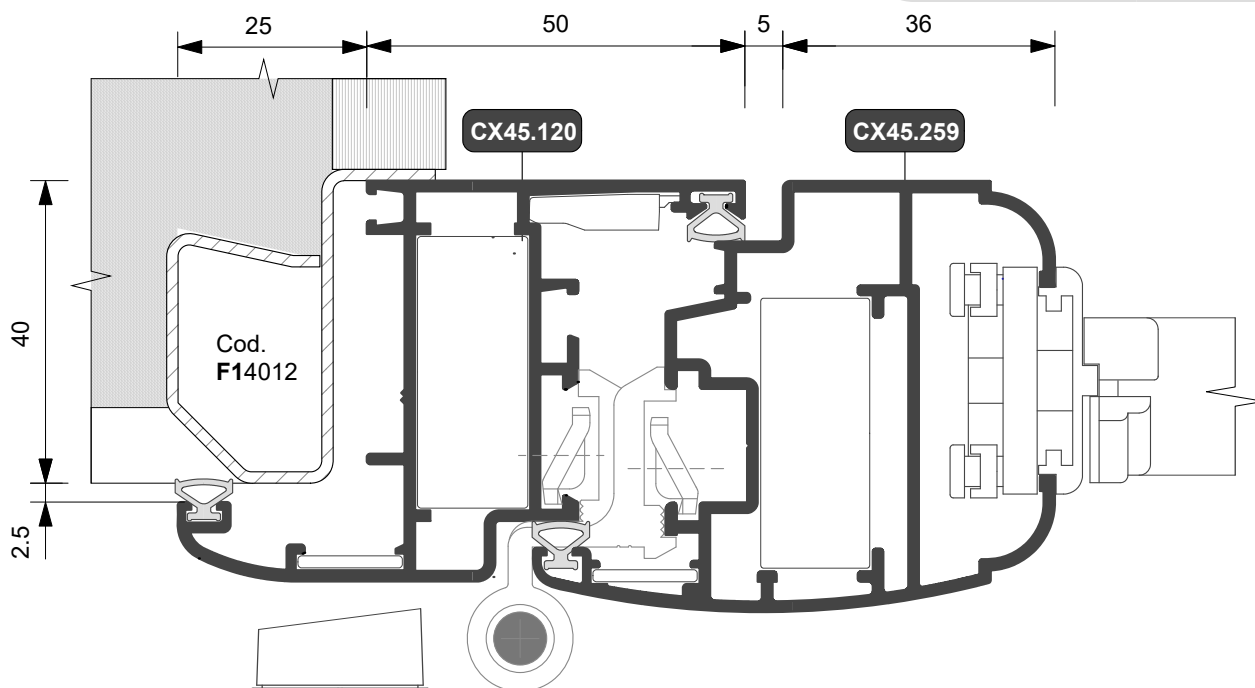
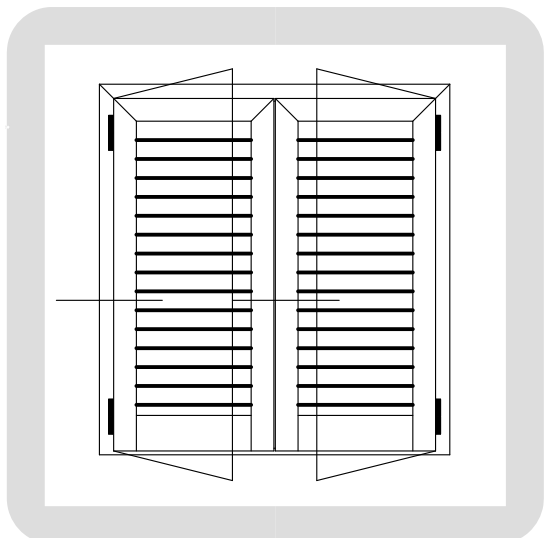



Linea **elite**

FINESTRA VETRO INFILARE
(entrata 25 mm.)

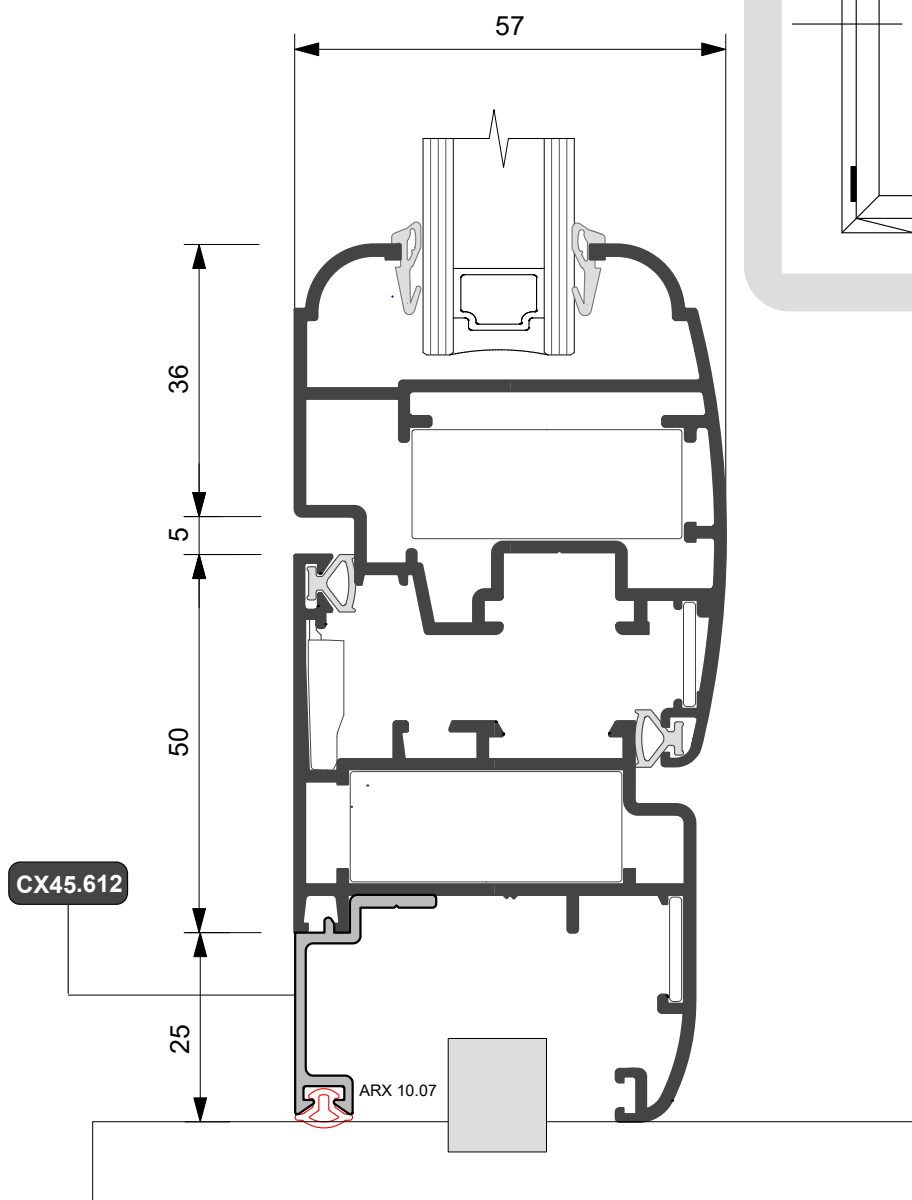
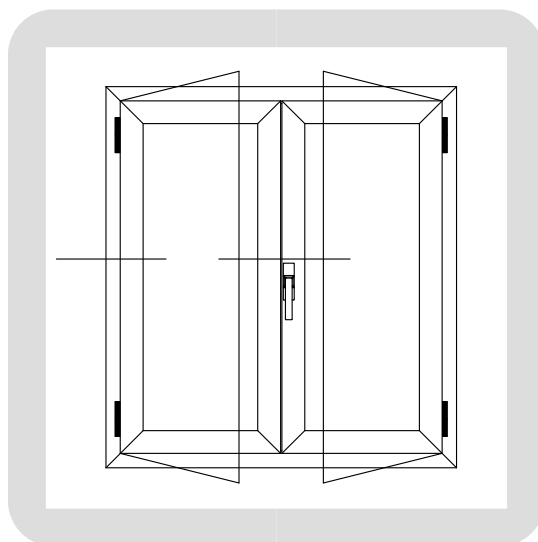



Linea Persiana
LUXOR 36.2 mm.

Entrata 36.2 mm.

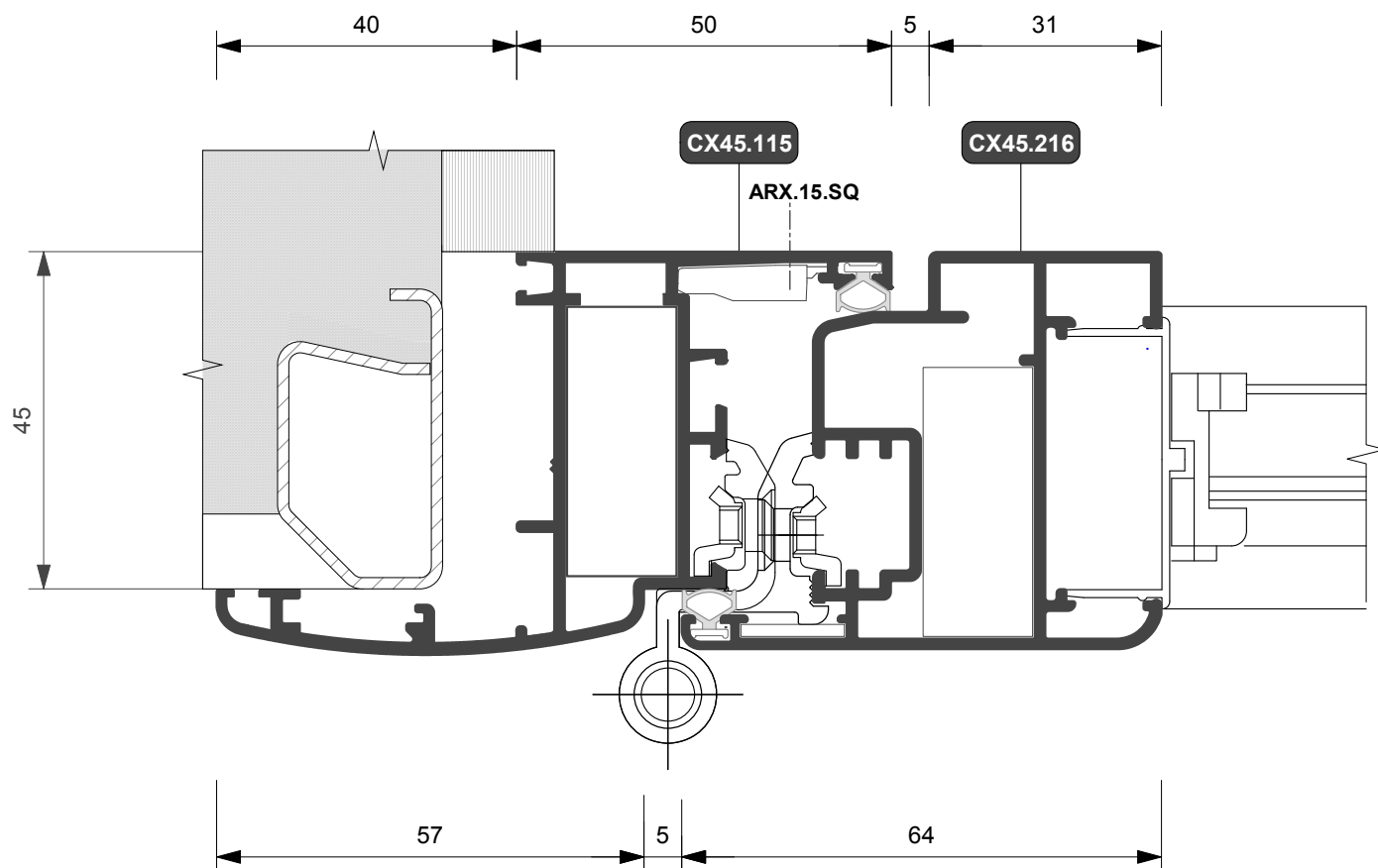
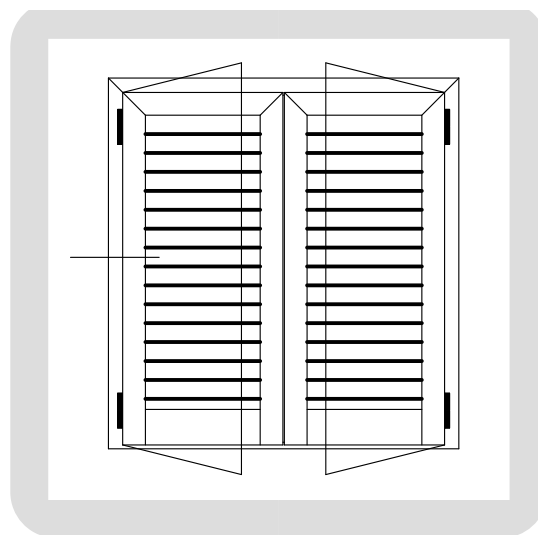



Linea Persiana
LUXOR 36.2 mm.

Entrata 36.2 mm.

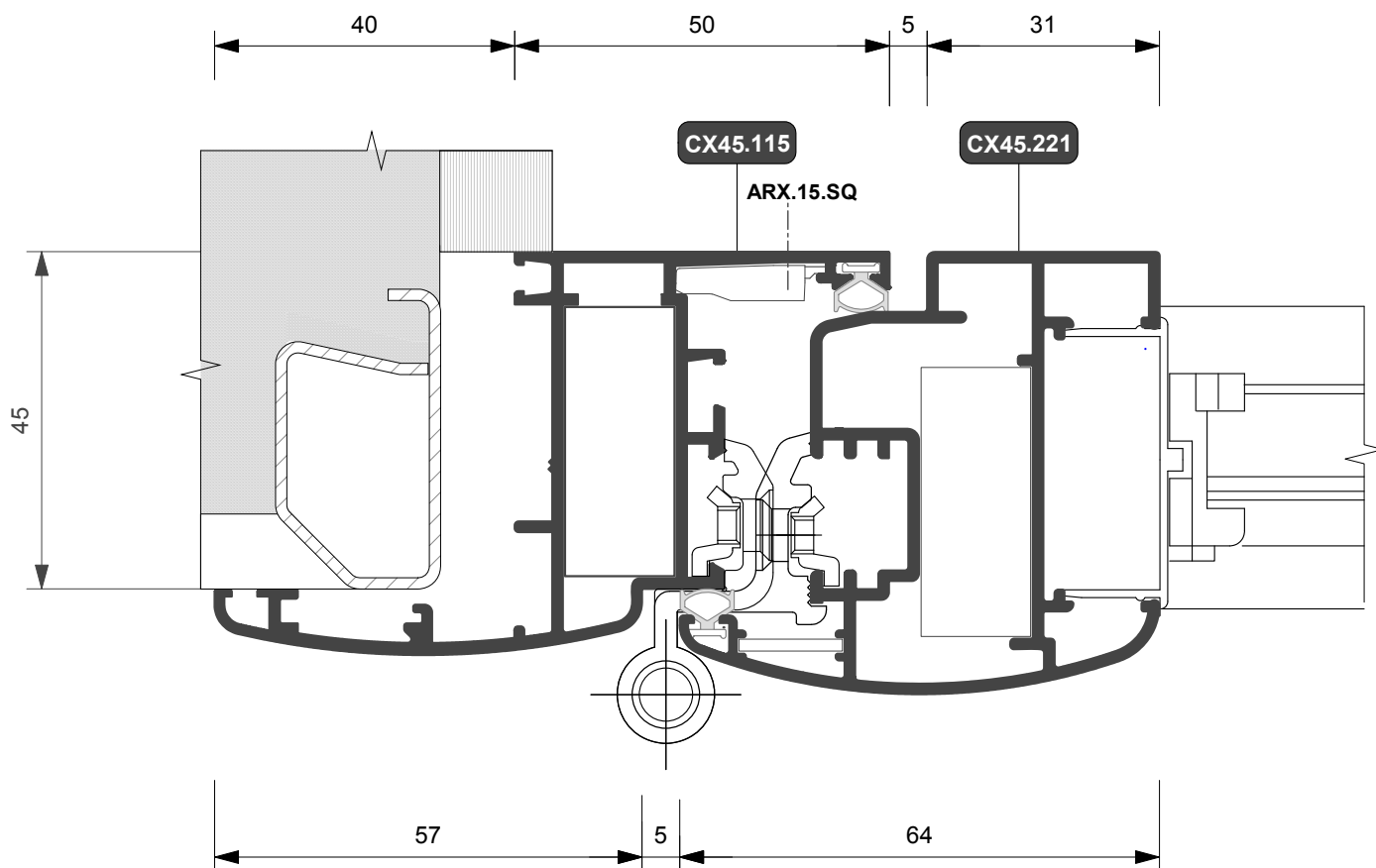
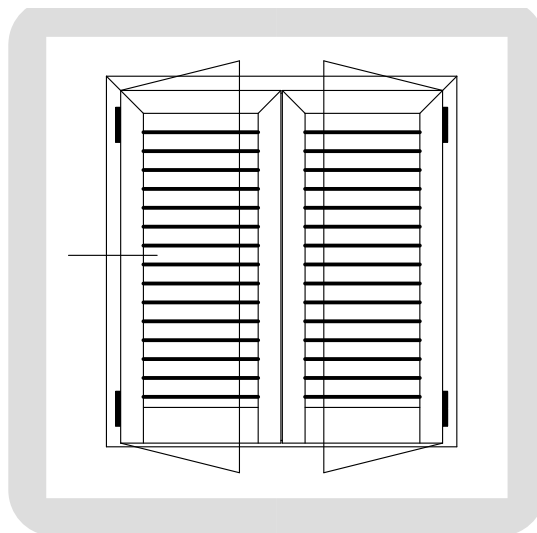



Linea Persiana
LUXOR 36.2 mm.

Entrata 36.2 mm.

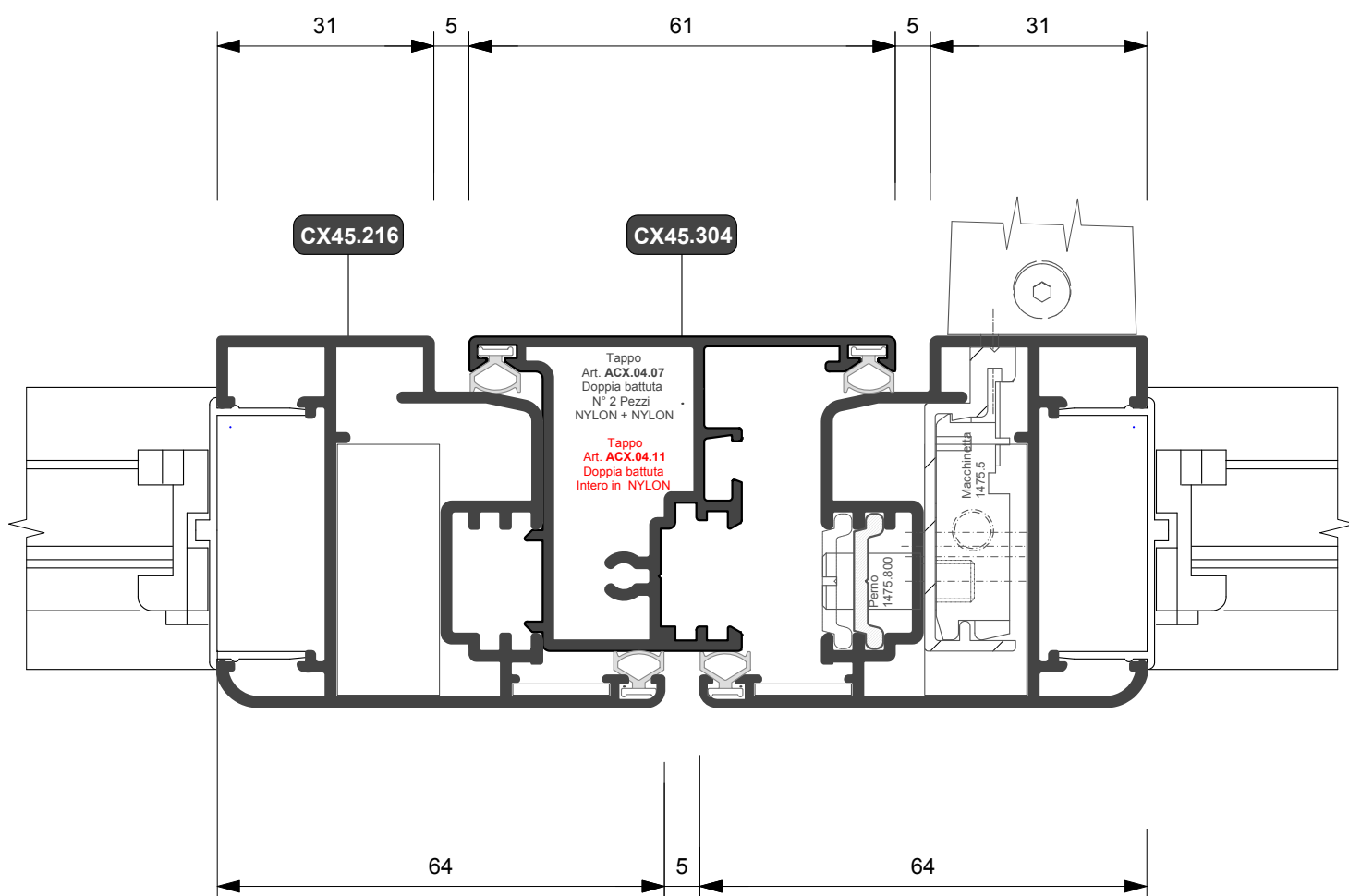
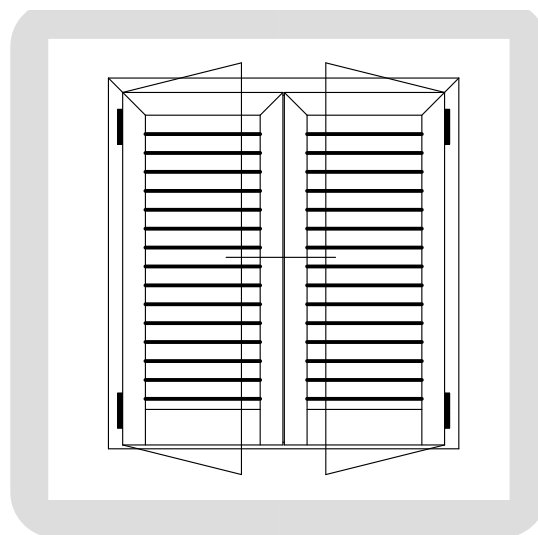



Linea Persiana
LUXOR 36.2 mm.

Entrata 36.2 mm.

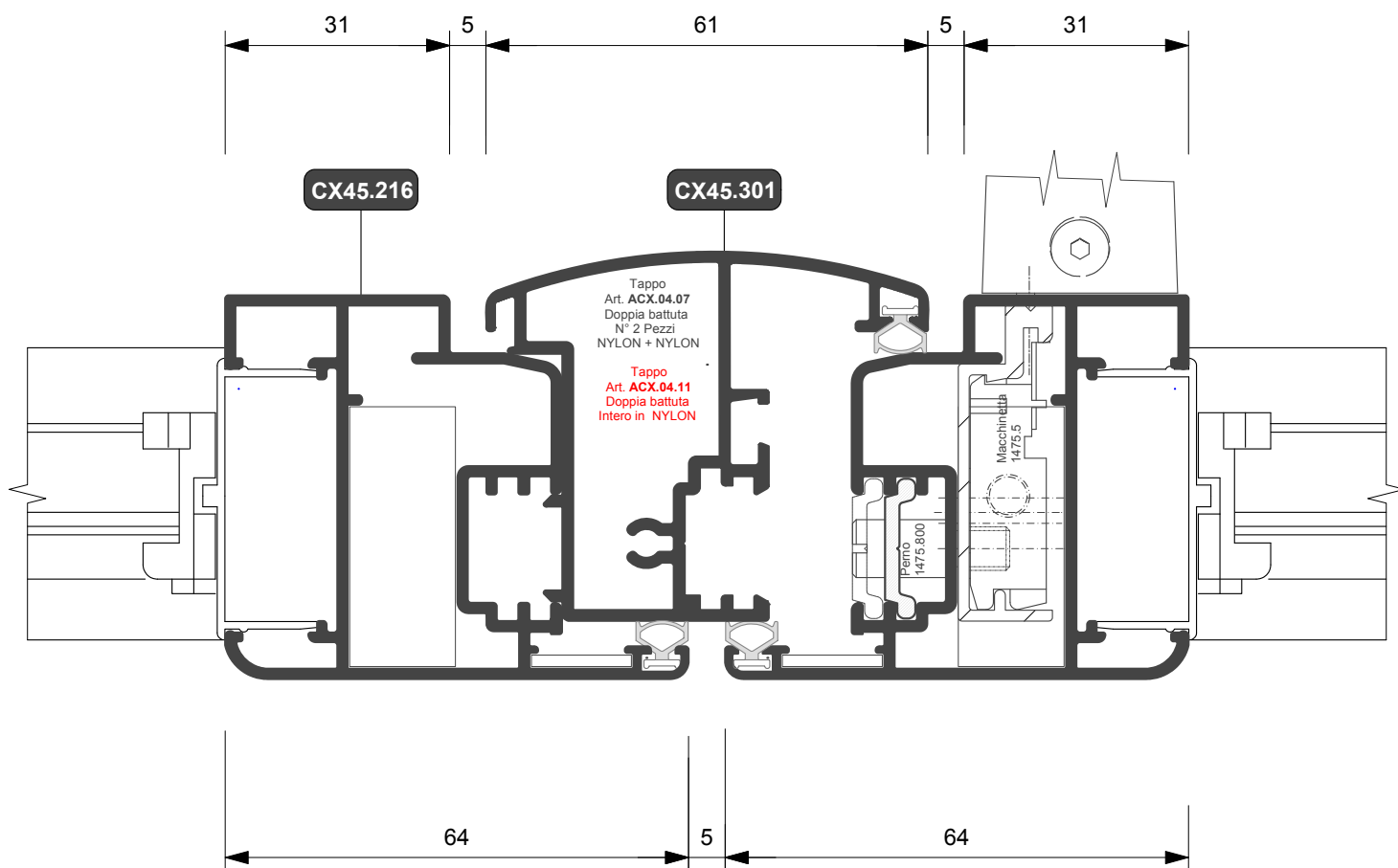
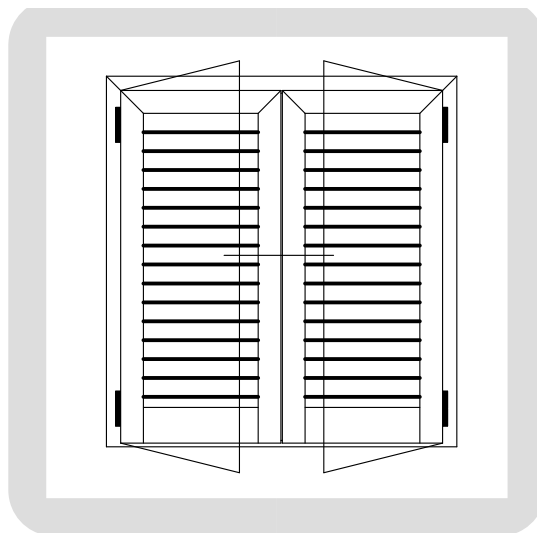

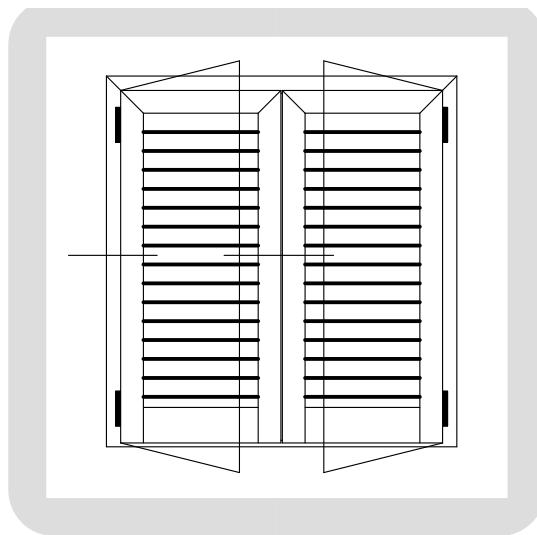
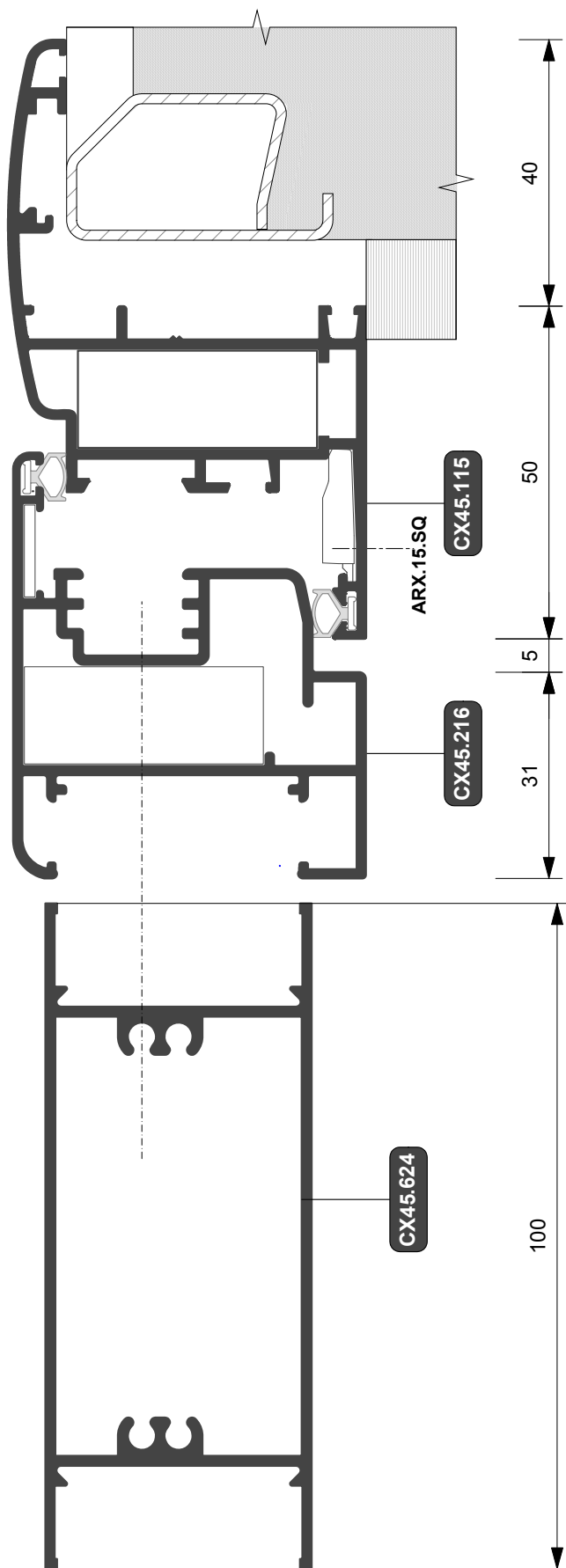

Linea Persiana
LUXOR 36.2 mm.

Entrata 36.2 mm.



**TWIN
SYSTEMS**

ARCHITETTURE IN ALLUMINIO



Tipologie
Types

Gruppo E

Principali tipologie di finestre | *Main types of windows*

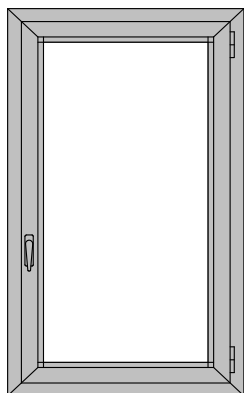

Finestra a 1 anta

Distinta di taglio vetri		
Q.ta	H	L
1	H -150	L -150

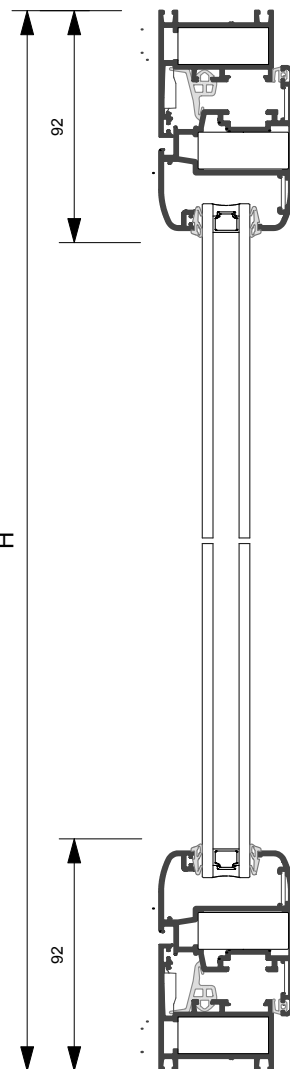
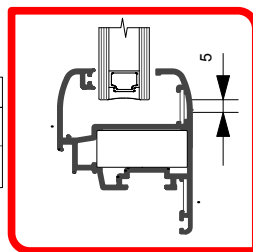

Accessori e guarnizioni

Codice	Descrizione	Q.ta	Codice	Descrizione	Q.ta
ACX.21.SQ	Squadretta a pulsante	8	ACX.05.01	Copriasola scarico acqua	2
ARX.15.SQ	Squadretta allin. telaio/anta	8	ACX.06.01	Espansore	*
ARX.10.SQ	Squadretta allin. anta int.	4	ARX.10.01	Guarnizione precamera	2L,2H
ACX.02.01	Cerniera a 2 ali	2	ACX.10.03	Guarnizione battuta	2L,2H
ACX.03.06	Cremonese pressofusa	1	ARX.10.05	Guarnizione vetro esterna	2L,2H
ACX.03.17	Innesti cremonese	2	*	Guarnizione vetro interna	2L,2H
ACX.03.18	Teminale astina	2	ARX.10.02	Angolo guarn. precamera	4
ACX.03.13	Ferrogliera singola	2			

* secondo dimensioni

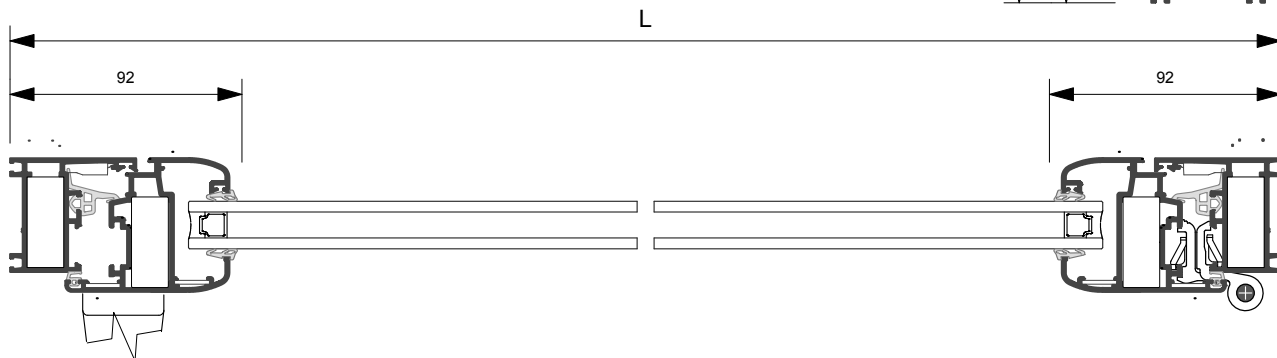

Profilo	Taglio	Q.ta	Profilo	Taglio	Q.ta	Profilo	Taglio	Q.ta
CX45.101 		2						
		2						
CX45.203 		2						
		2						

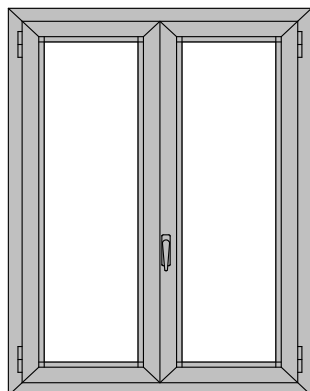

Finestra a 2 ante

Distinta di taglio vetri		
Q.ta	H	L
2	H -150	L/2 -130.5

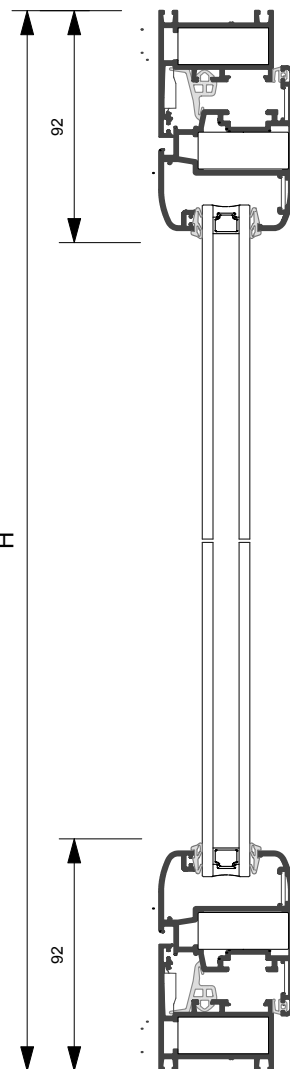
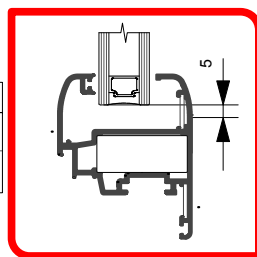





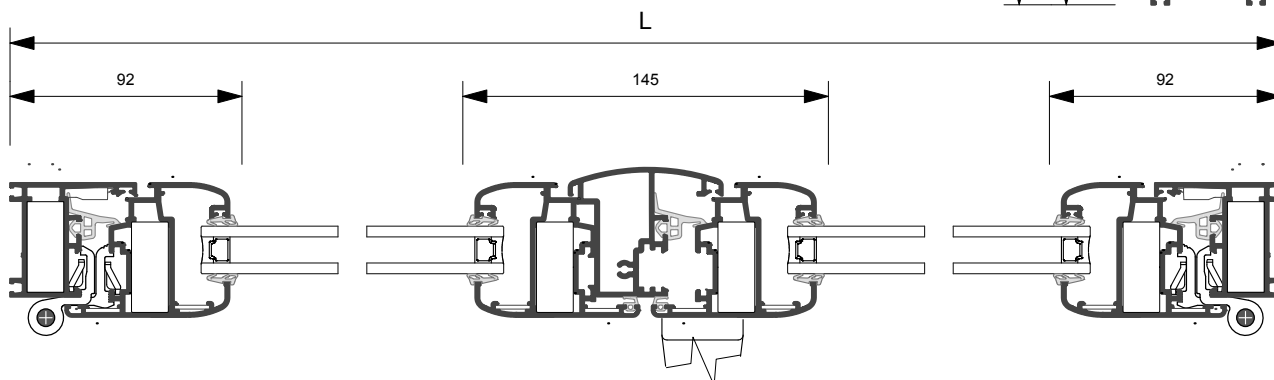

Accessori e guarnizioni

Codice	Descrizione	Q.ta	Codice	Descrizione	Q.ta
ACX.01.SQ	Squadretta a pulsante	12	ACX.04.05	Tappo riporto centrale	1
ARX.15.SQ	Squadretta allin. telaio/anta	12	ACX.05.01	Copriasola scarico acqua	2
ARX.10.SQ	Squadretta allin. anta int.	8	ACX.06.01	Espansore	*
ACX.02.01	Cerniera a 2 ali	4	ARX.10.01	Guarnizione precamera	2L,3H
ACX.03.06	Cremonese pressofusa	1	ACX.10.03	Guarnizione battuta	2L,4H
ACX.03.17	Innesti cremonese	2	ARX.10.05	Guarnizione vetro esterna	2L,4H
ACX.03.18	Teminale astina	2	*	Guarnizione vetro interna	2L,4H
ACX.03.11	Paletto a spinta	2	ARX.10.02	Angolo guarn. precamera	4
ACX.03.14	Ferrogliera doppia	2			

* secondo dimensioni



Profilo	Taglio	Q.ta	Profilo	Taglio	Q.ta	Profilo	Taglio	Q.ta
CX45.101	 L	2	CX45.301	 H - 110	1			
	 H	2						
CX45.203	 L/2 - 24.5	4		 H - 44				
	 H - 44	4						

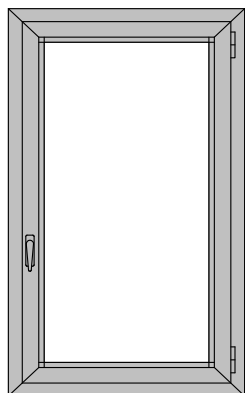

Finestra a 1 anta

Distinta di taglio vetri		
Q.ta	H	L
1	H - 150	L - 150

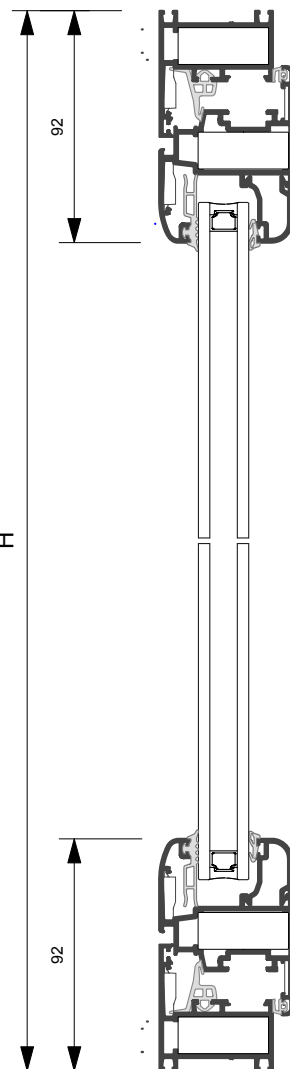
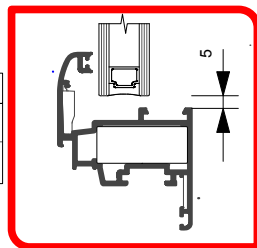

Accessori e guarnizioni

Codice	Descrizione	Q.ta	Codice	Descrizione	Q.ta
ACX.01.SQ	Squadretta a pulsante	8	ACX.05.01	Copriasola scarico acqua	2
ARX.15.SQ	Squadretta allin. telaio/anta	8	ACX.06.01	Espansore	*
ARX.10.SQ	Squadretta allin. anta int.	4	ACX.07.02	Angolo pressof. fermavetro	4
ACX.02.01	Cerniera a 2 ali	2	ARX.10.01	Guarnizione precamera	2L,2H
ACX.03.06	Cremonese pressofusa	1	ACX.10.03	Guarnizione battuta	2L,2H
ACX.03.17	Innesti cremonese	2	ARX.10.05	Guarnizione vetro esterna	2L,2H
ACX.03.18	Teminale astina	2	*	Guarnizione vetro interna	2L,2H
ACX.03.13	Ferrogliera singola	2	ARX.10.02	Angolo guarn. precamera	4

* secondo dimensioni

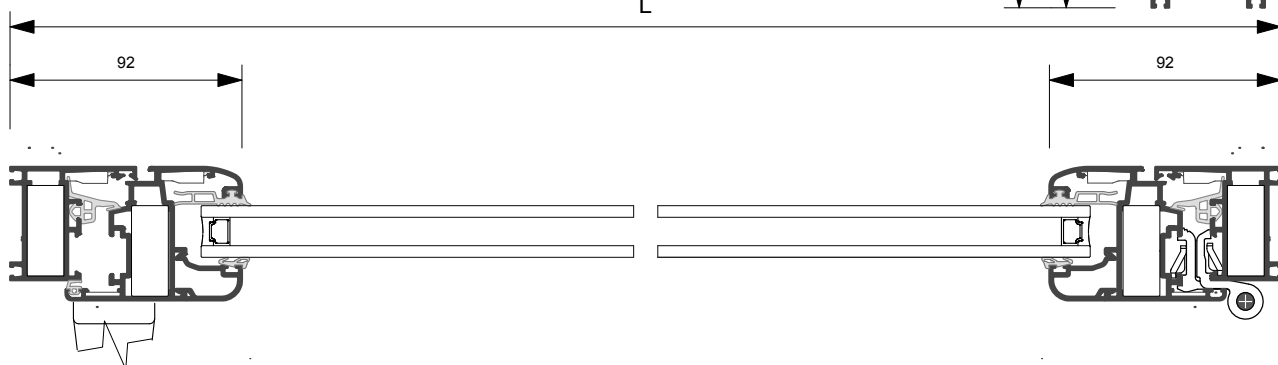

Profilo	Taglio	Q.ta	Profilo	Taglio	Q.ta	Profilo	Taglio	Q.ta
CX45.101 	L	2	CX70.521 	L - 184	2			
	H	2		H - 184	2			
CX45.201 	L - 44	2						
	H - 44	2						

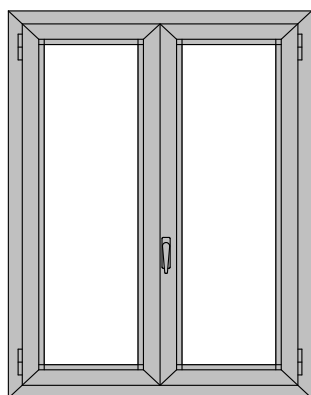

Finestra a 2 ante

Distinta di taglio vetri		
Q.tà	H	L
2	H - 150	L/2 - 130.5

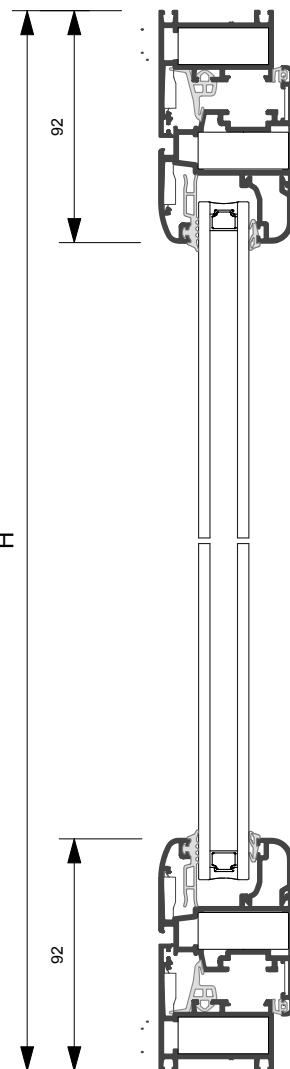
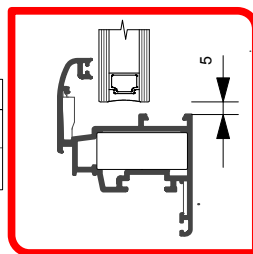

Accessori e guarnizioni

Codice	Descrizione	Q.ta	Codice	Descrizione	Q.ta
ACX.01.SQ	Squadretta a pulsante	12	ACX.04.05	Tappo riporto centrale	1
ARX.15.SQ	Squadretta allin. telaio/anta	12	ACX.05.01	Copriasola scarico acqua	2
ARX.10.SQ	Squadretta allin. anta int.	8	ACX.06.01	Espansore	*
ACX.02.01	Cerniera a 2 ali	4	ACX.07.02	Angolo pressof. fermavetro	8
ACX.03.06	Cremonese pressofusa	1	ARX.10.01	Guarnizione precamera	2L,3H
ACX.03.17	Innesti cremonese	2	ACX.10.03	Guarnizione battuta	2L,4H
ACX.03.18	Teminale astina	2	ACX.10.05	Guarnizione vetro esterna	2L,4H
ACX.03.11	Paletto a spinta	2	*	Guarnizione vetro interna	2L,4H
ACX.03.14	Ferrogliera doppia	2	ACX.10.02	Angolo guarn. precamera	4

* secondo dimensioni

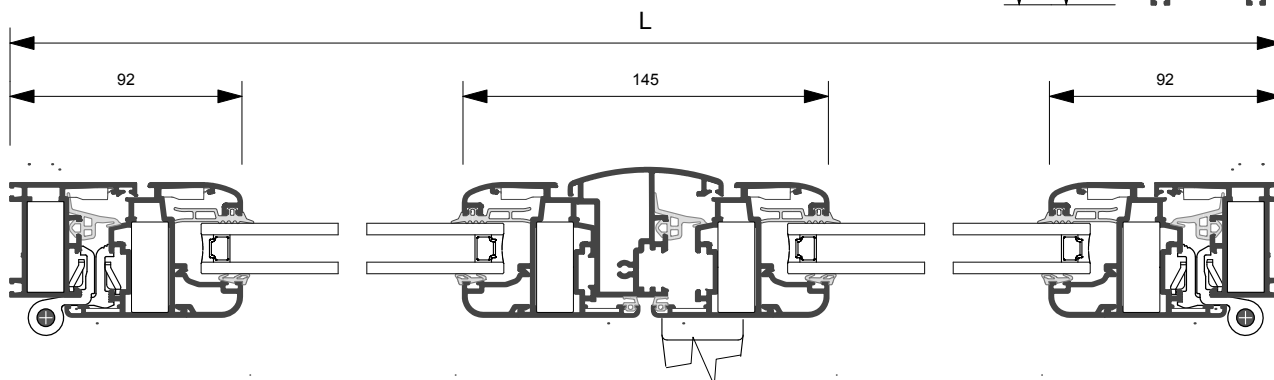

Profilo	Taglio	Q.ta	Profilo	Taglio	Q.ta	Profilo	Taglio	Q.ta
CX45.101	L	2	CX70.521	L/2 - 164.5	4			
	H	2		H - 184	4			
CX45.201	L/2 - 24.5	4	CX45.301	H - 110	1			
	H - 44	4						

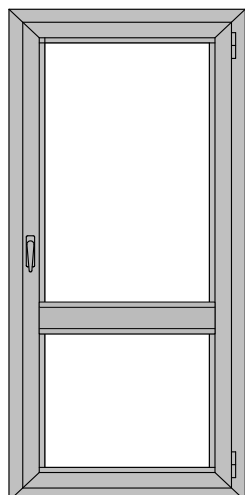

Porta a 1 anta

Distinta di taglio vetri		
Q.ta	H	L
1	H-HF-58	L -150
1	HF -154	L -150

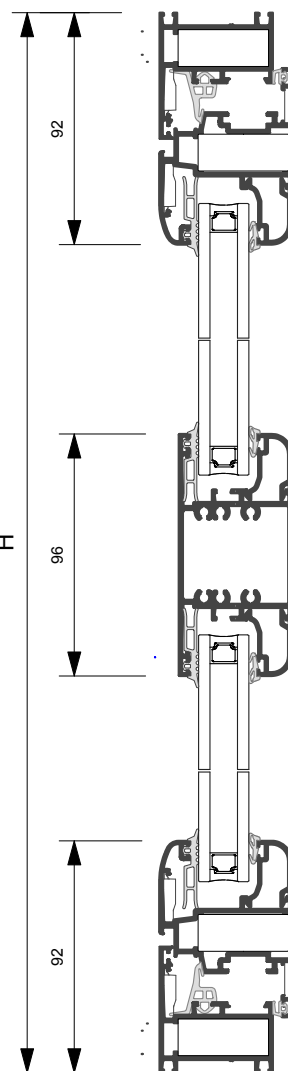
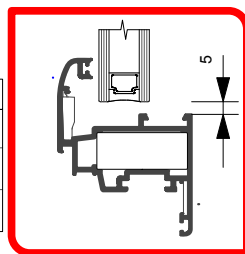

Accessori e guarnizioni

Codice	Descrizione	Q.ta	Codice	Descrizione	Q.ta
ACX.01.SQ	Squadretta a pulsante	8	ACX.05.01	Copriasola scarico acqua	2
ARX.15.SQ	Squadretta allin. telaio/anta	8	ACX.06.01	Espansore	*
ARX.10.SQ	Squadretta allin. anta int.	4	ACX.07.02	Angolo pressof. fermavetro	8
ACX.02.01	Cerniera a 2 ali	3	ARX.10.01	Guarnizione precamera	2L,2H
ACX.03.06	Cremonese pressofusa	1	ACX.10.03	Guarnizione battuta	2L,2H
ACX.03.17	Innesti cremonese	2	ARX.10.05	Guarnizione vetro esterna	4L,2H
ACX.03.18	Teminale astina	2	*	Guarnizione vetro interna	4L,2H
ACX.03.13	Ferrogliera singola	2	ARX.10.02	Angolo guarn. precamera	4

* secondo dimensioni

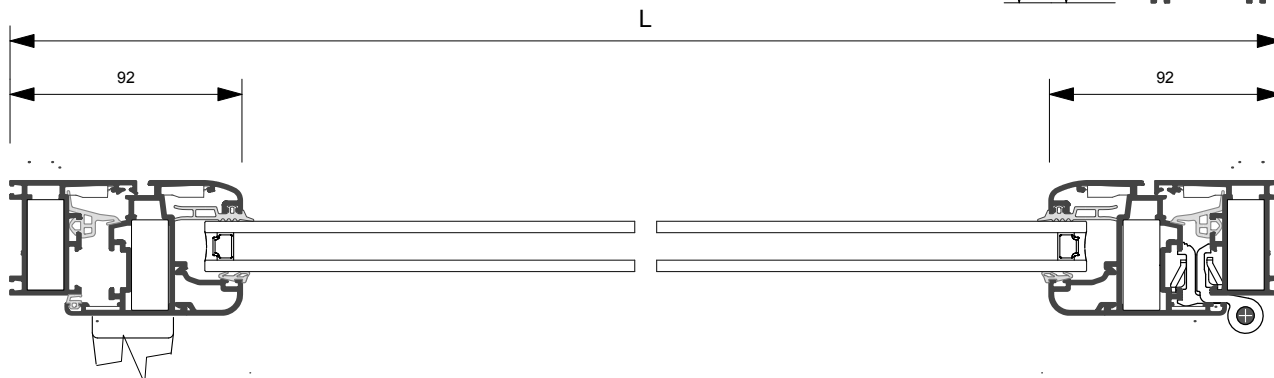

Profilo	Taglio	Q.ta	Profilo	Taglio	Q.ta	Profilo	Taglio	Q.ta
CX45.101 	L	2	CX70.521 	L - 184	4	CX45.402 	L - 130	1
	H	2		H - HF -92	2			
CX45.201 	L - 44	2		HF - 188	2			
	H - 44	2						

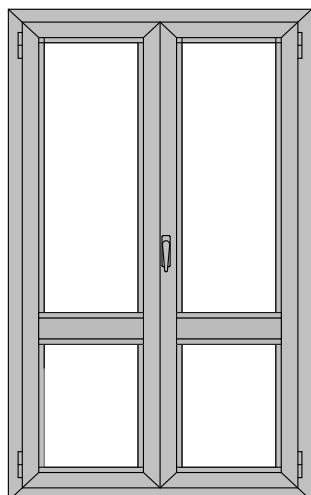

Porta a 2 ante

Distinta di taglio vetri		
Q.tà	H	L
1	H-HF-58	L/2 -130.5
1	HF -154	L/2 -130.5

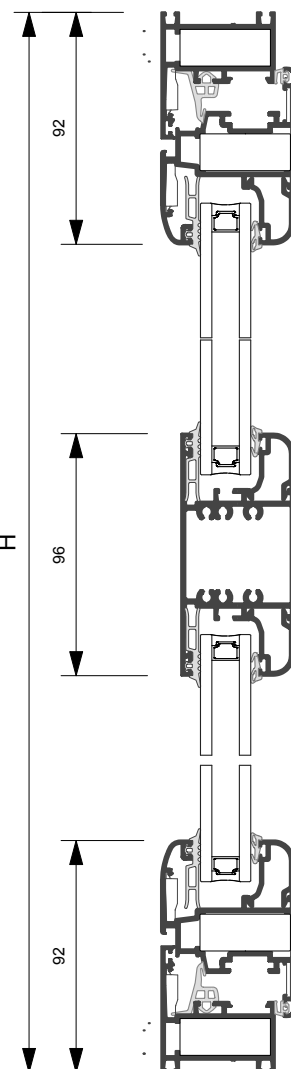
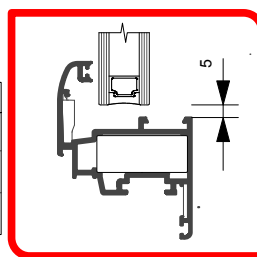

Accessori e guarnizioni

Codice	Descrizione	Q.ta	Codice	Descrizione	Q.ta
ACX.01.SQ	Squadretta a pulsante	12	ACX.04.05	Tappo riporto centrale	1
ARX.15.SQ	Squadretta allin. telaio/anta	12	ACX.05.01	Copriasola scarico acqua	2
ARX.10.SQ	Squadretta allin. anta int.	8	ACX.06.01	Espansore	*
ACX.02.01	Cerniera a 2 ali	6	ACX.07.02	Angolo pressof. fermavetro	16
ACX.03.06	Cremonese pressofusa	1	ARX.10.01	Guarnizione precamera	2L,3H
ACX.03.17	Innesti cremonese	2	ACX.10.03	Guarnizione battuta	2L,4H
ACX.03.18	Teminale astina	2	ARX.10.05	Guarnizione vetro esterna	4L,4H
ACX.03.11	Paletto a spinta	2	*	Guarnizione vetro interna	4L,4H
ACX.03.14	Ferrogliera doppia	2	ARX.10.02	Angolo guarn. precamera	4

* secondo dimensioni

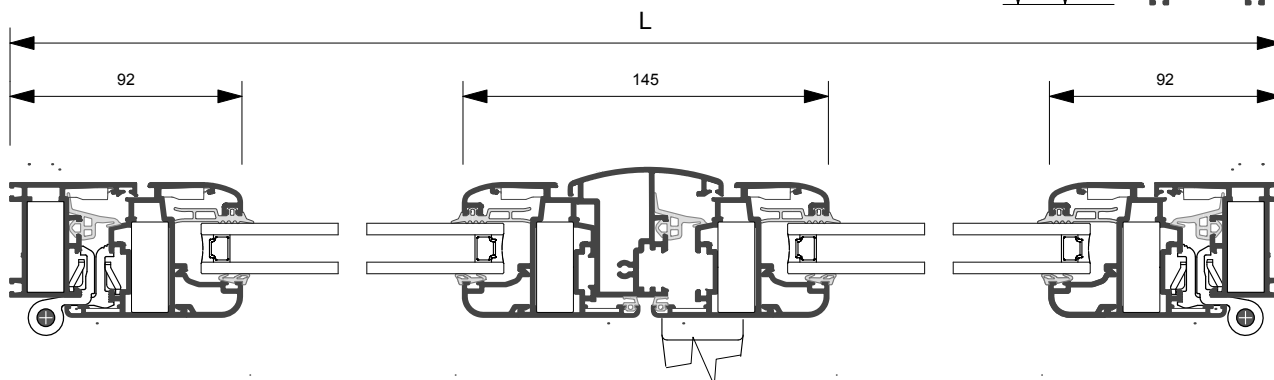

Profilo	Taglio	Q.ta	Profilo	Taglio	Q.ta	Profilo	Taglio	Q.ta
CX45.101	L	2	CX70.521	L/2 - 164.5	8	CX45.301	H - 110	1
	H	2		H - HF - 92	4			
CX45.201	L/2 - 24.5	4		HF - 188	4	CX45.402	L/2 - 110.5	2
	H - 44	2		1				



**TWIN
SYSTEMS**

ARCHITETTURE IN ALLUMINIO



Collegamento Muratura
Wall Joint

Gruppo F

Sezione particolareggiata
attacco alla muratura | *Wall Joint
Detail*



FISSAGGIO ALLA MURATURA
FIXING ON MASONRY

ARX.06.01	
Descrizione	Registro Universale
Materiale	Nylon

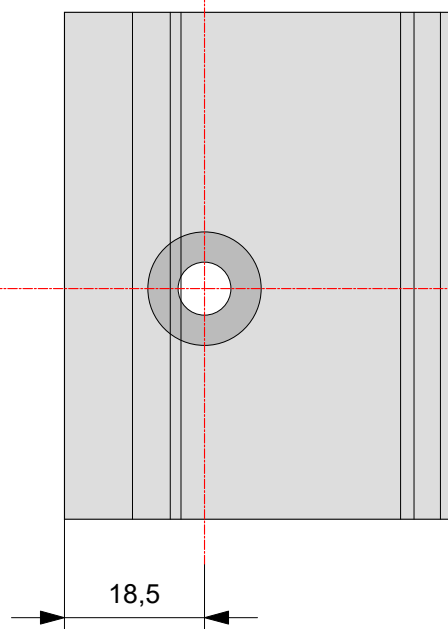
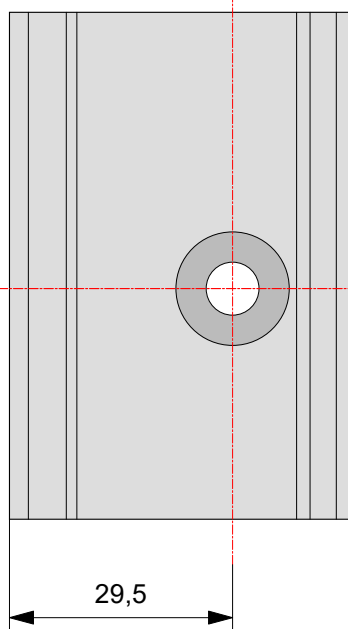
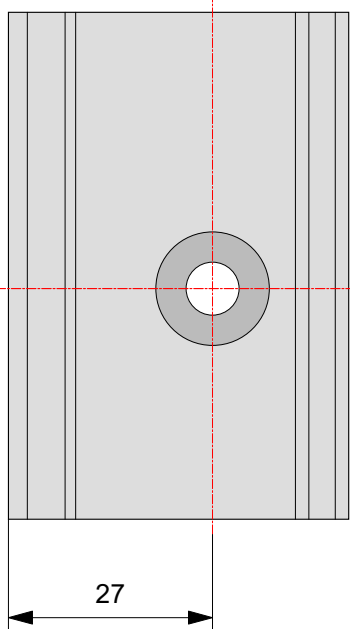
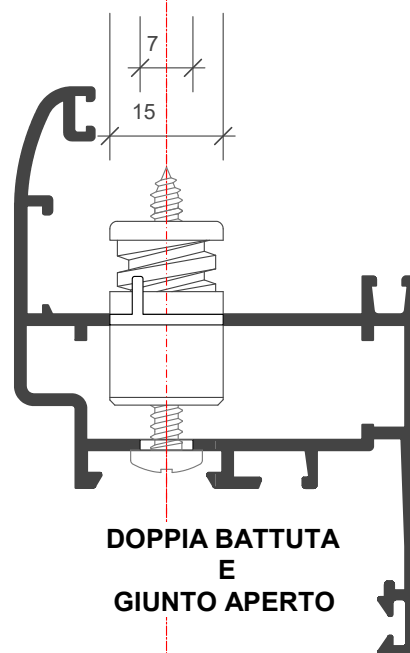
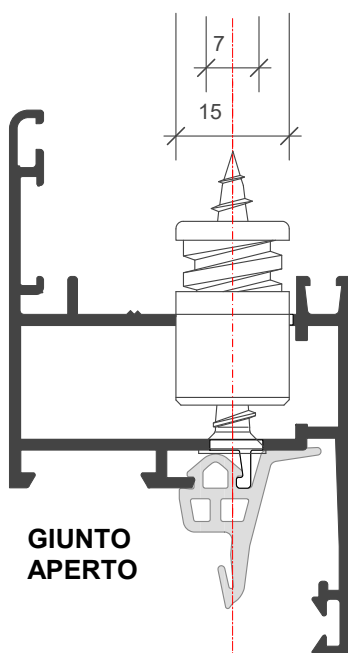
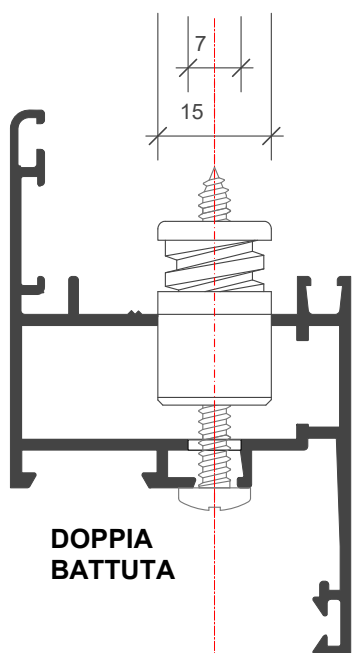
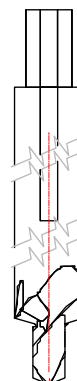



CONTROTELAIO | COUNTERFRAME
Flash Tre Thermic®

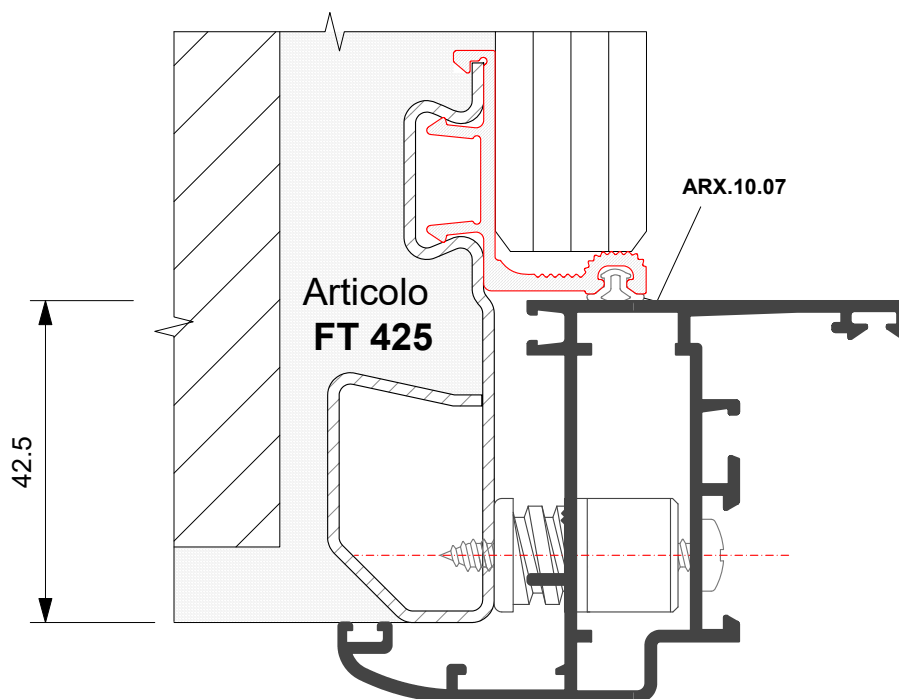
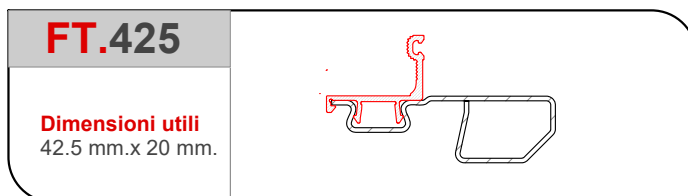



CONTROTELAIO | COUNTERFRAME

Uno®

F14012

Dimensioni utili
40 mm.x 15 mm.

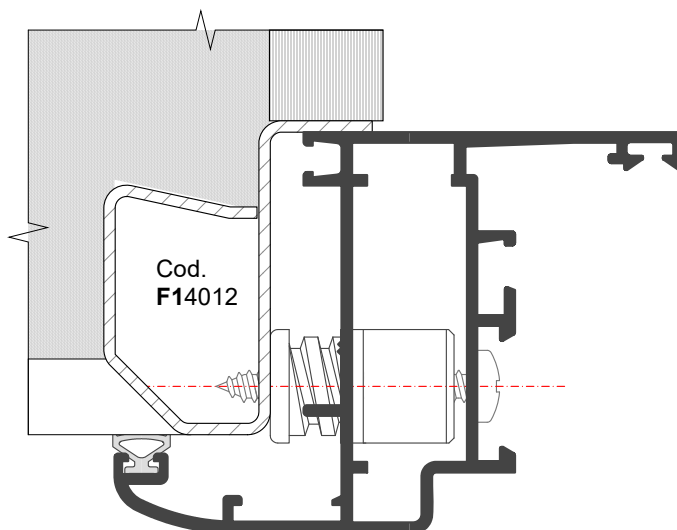
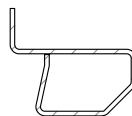



CONTROTELAIO | COUNTERFRAME

Uno®

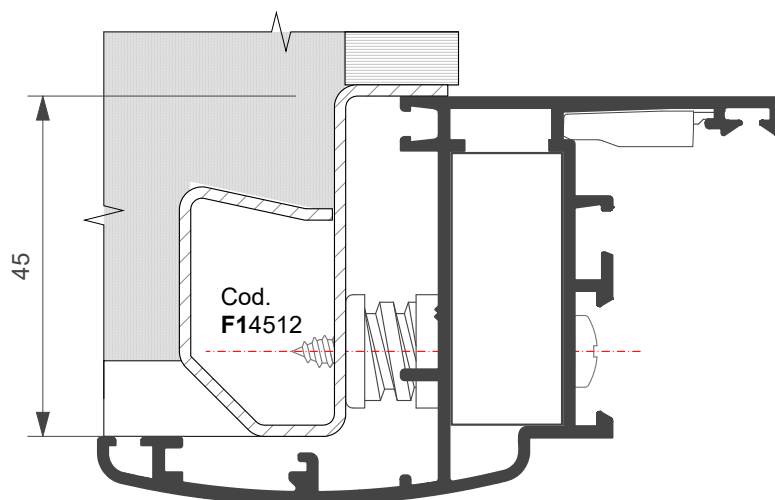
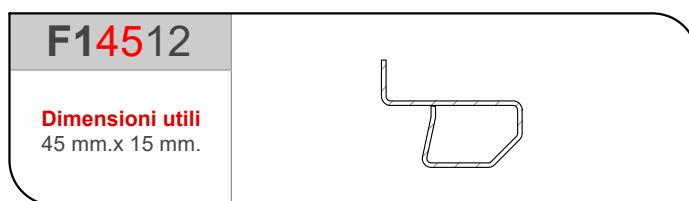



**TWIN
SYSTEMS**

ARCHITETTURE IN ALLUMINIO



Lavorazioni/Montaggi
Processing/Assembly

Gruppo G

Schemi Lavorazioni | *Processing Schemes*
Frese | *Mills*
Attrezzature | *Equipment*





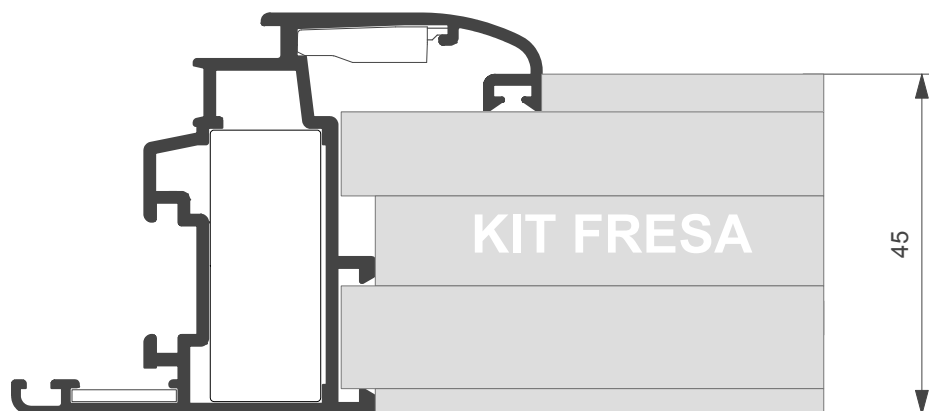
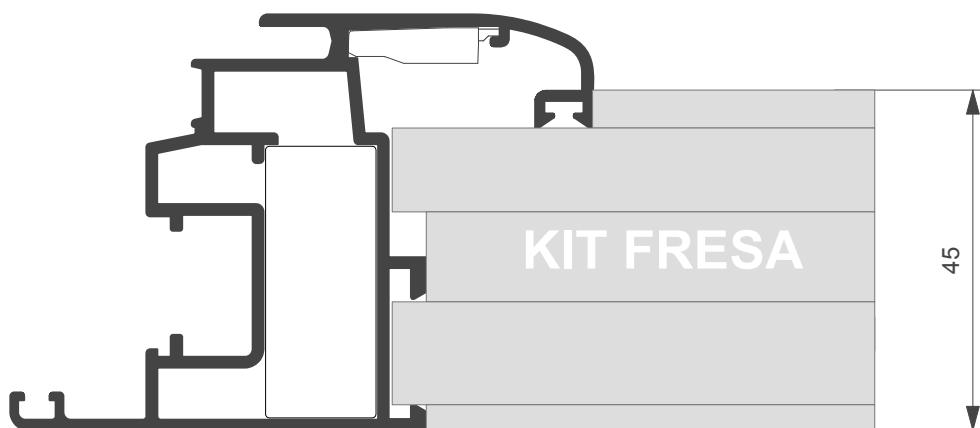
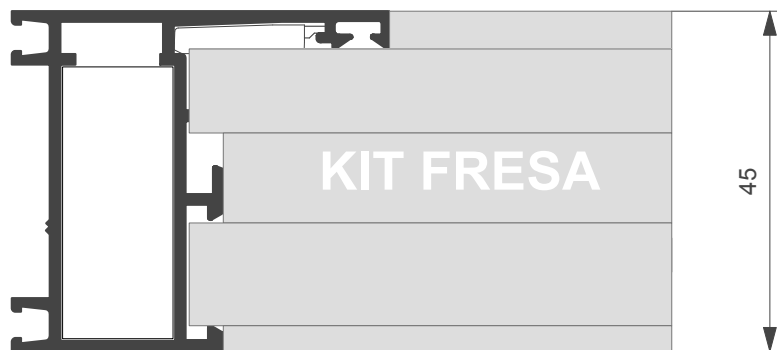



ACX.09.03

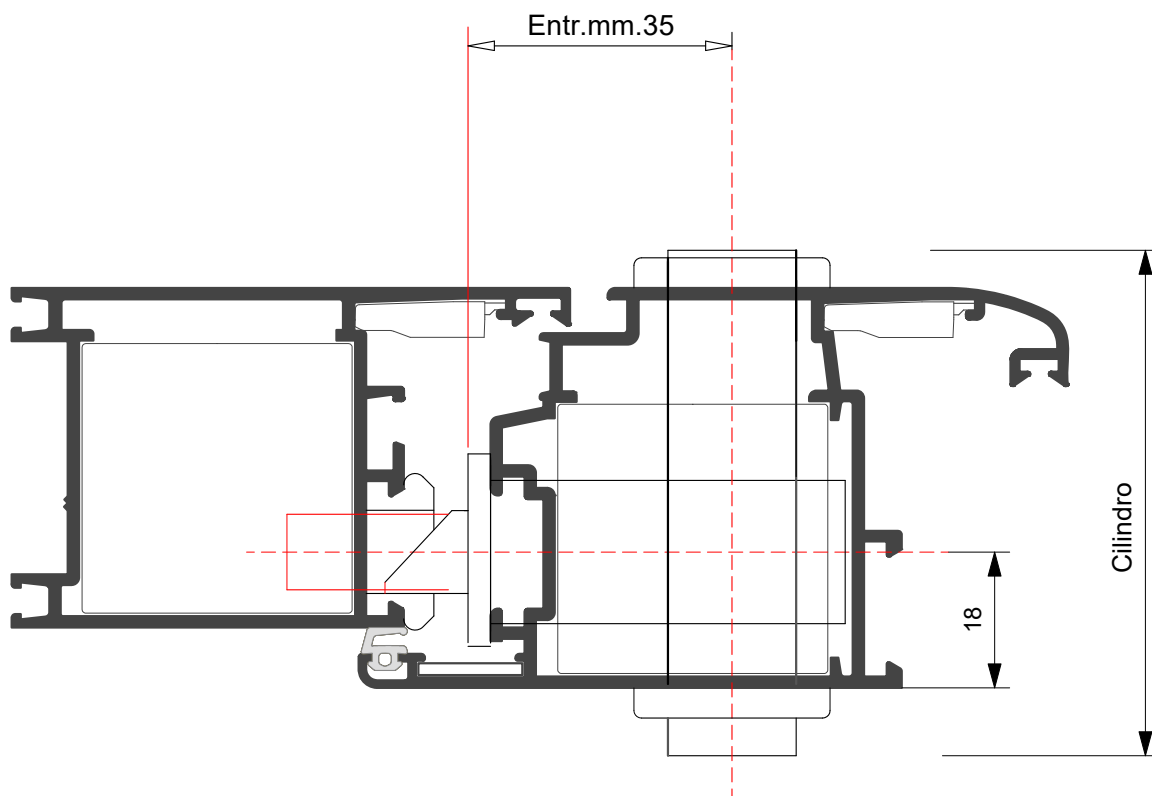

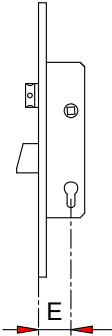

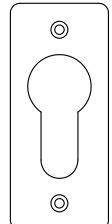
SERRATURE SICUREZZA DA MONTANTE MORTICE LOCK

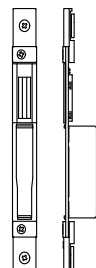

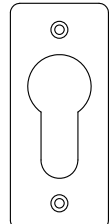
	Serratura E= 35 mm Lock		Contropiastra Counterplate			Cilindro Cylinder		Borchia Cover
	Tipologia Type	Art.	Nylon Nylon	Metallo Metal	Registrabile Adjustable	 Tradizionale Classic	 Sicurezza Safety	 0120N
Catenaccio e Scrocco Deadbolt and Latch	1450	 02396N	 02396L	 02396X	 Tradizionale Classic	 Sicurezza Safety	 0120N	
Catenaccio e Rullo Bolt and Roller Cam	1455							
Elettrica con maniglia Electric Lock with Handle	1457							



SERRATURE TRIPLICI DI SICUREZZA DA MONTANTE

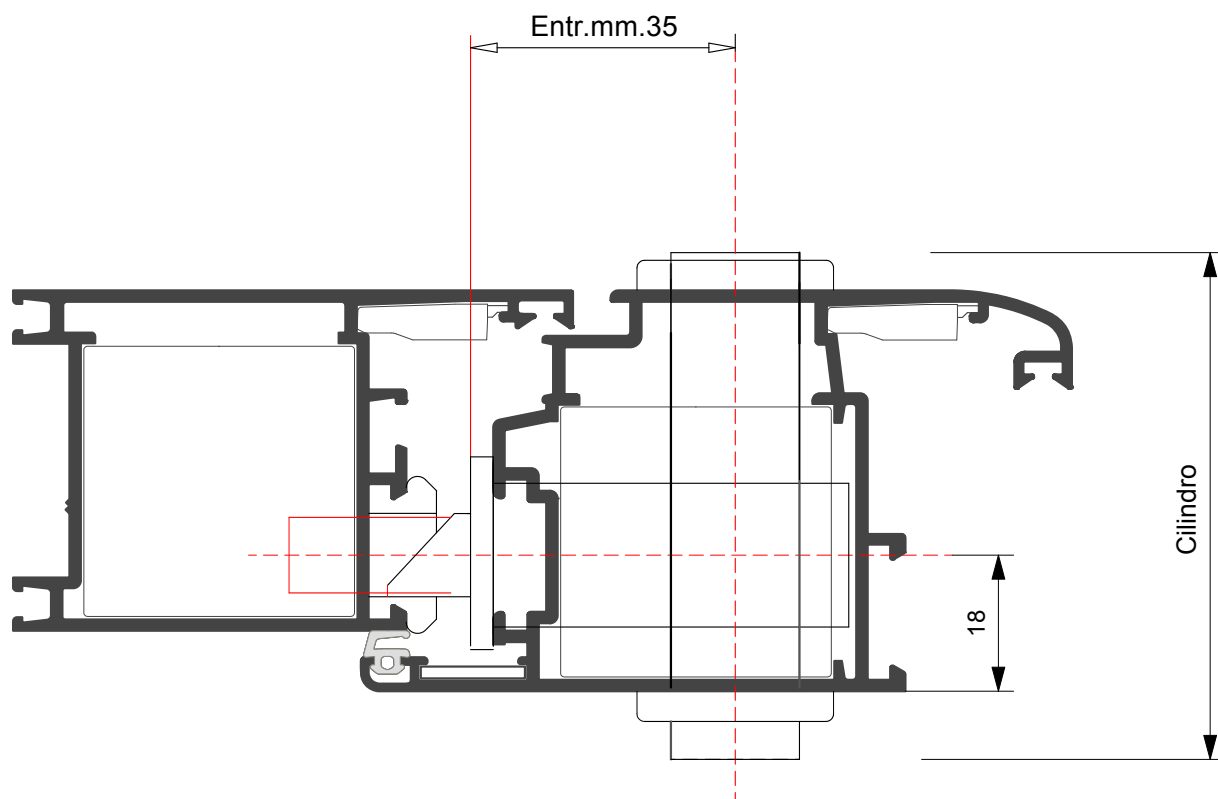



	Serratura E= 35 mm		Contropiastra			Cilindro		Borchia
	Tipologia	Art.	Nylon	Metallo	Registrabile	Tradizionale	Sicurezza	
	Catenaccio e scrocco	1480						
	Catenaccio e rullo	1485				120/07	2120/015	
	Elettrica con maniglia	1487						
			02696N	03196L	02396L			0120N

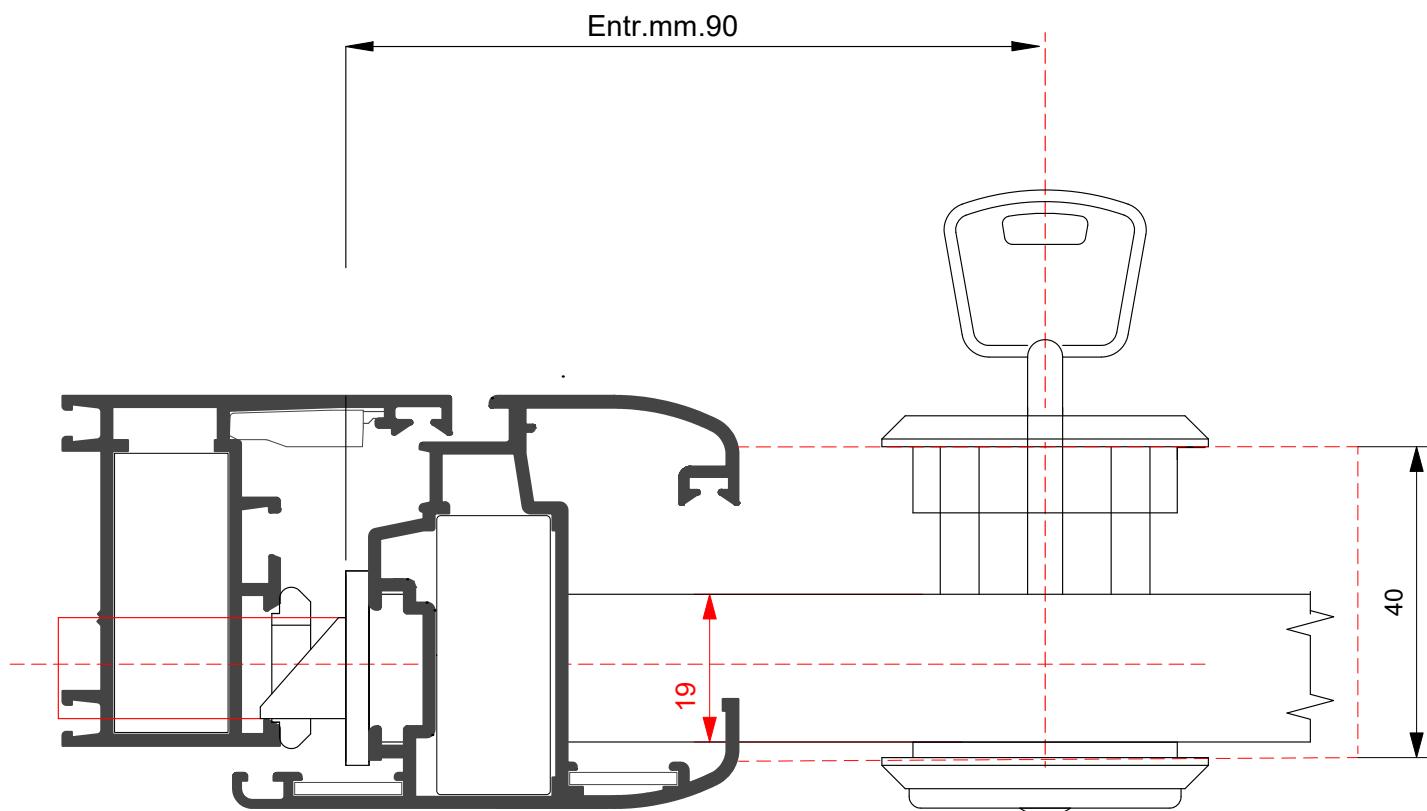

SERRATURE DI SICUREZZA A DOPPIA MAPPA *DOUBLE BIT SECURITY LOCKS*

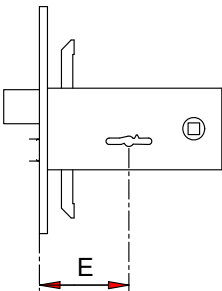
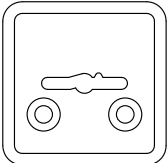
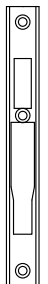
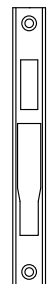
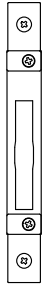

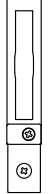





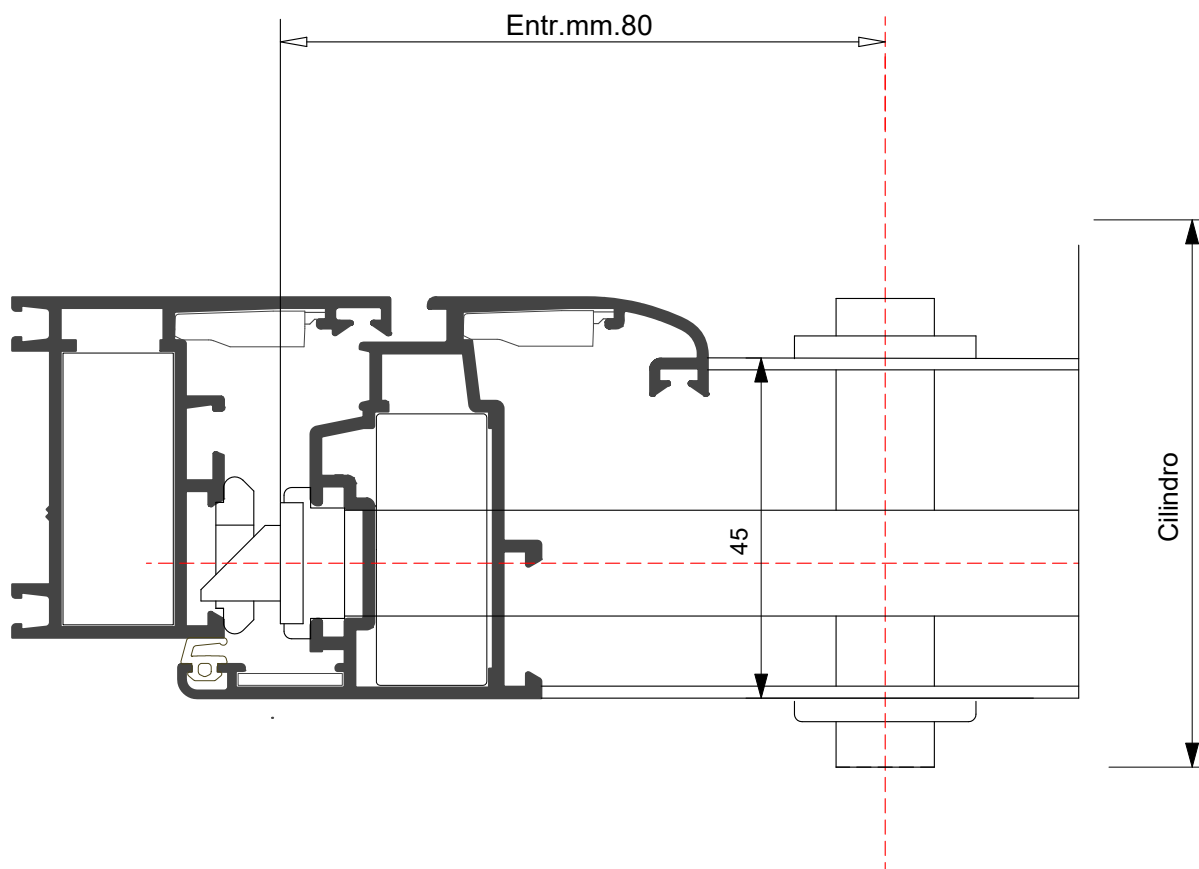

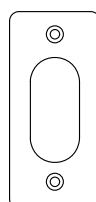
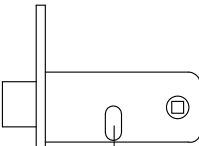

	Serratura Doppia Mappa <i>Double Bit Security Lock</i> E= 90 mm			Contropiastra <i>Counterplate</i>			Borchia <i>Cover</i>
	Tipologia <i>Type</i>	Art.	Art.	Nylon <i>Nylon</i>	Metallo <i>Metal</i>	Registrabile <i>Adjustable</i>	 0590N in dotazione <i>supplied</i>
Catenaccio e Scrocco <i>Deadbolt and Latch</i>	5960/1	5970/1					
Catenaccio e Rullo <i>Bolt and Roller Cam</i>	5965/1	5975/1					
Elettrica con maniglia <i>Electric Lock with Handle</i>	5968/1	5978/1	02396N	02396L	02381X		

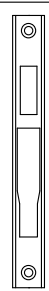

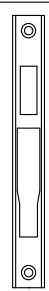
SERRATURE A FASCIA

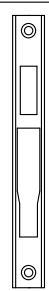

	Serratura E=80 mm <i>Lock</i>		Contropiastra <i>Counterplate</i>			Cilindro <i>Cylinder</i>		Borchia <i>Cover</i>
	Tipologia <i>Type</i>	Art.	Nylon <i>Nylon</i>	Metallo <i>Metal</i>	Registrabile <i>Adjustable</i>			
	Catenaccio e Scrocco <i>Deadbolt and Latch</i>	880				Tradizionale <i>Classic</i>	Sicurezza <i>Safety</i>	
	Catenaccio e Rullo <i>Bolt and Roller Cam</i>	885						
	Elettrica con maniglia <i>Electric Lock with Handle</i>	888						
			02381N	02381L	02381X			



APPLICAZIONE TAPPI CAPS INSTALLATION

ACX.04.16

Descrizione
Tappo chiudi-tubolarità
Anta persiana CX45.259 Elite
 Materiale
Nylon

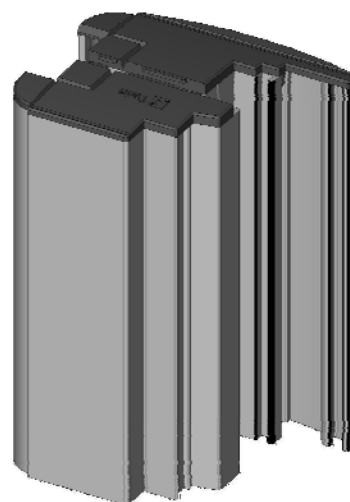
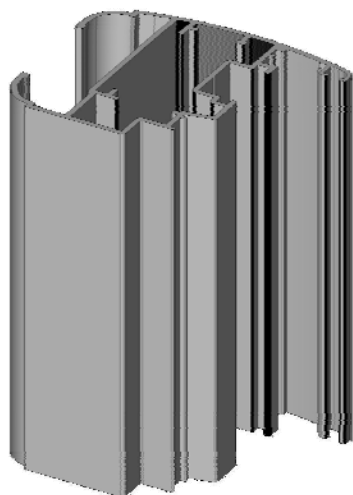
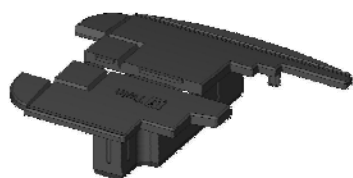
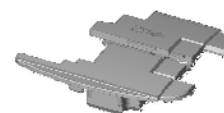

ACX.04.15

Descrizione
Tappo chiudi-tubolarità
Profilo riporto CX45.351 Elite
 Materiale
Nylon

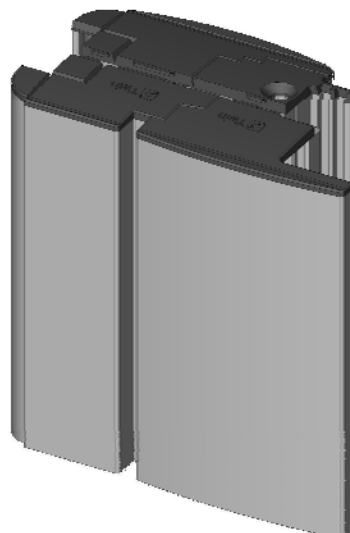
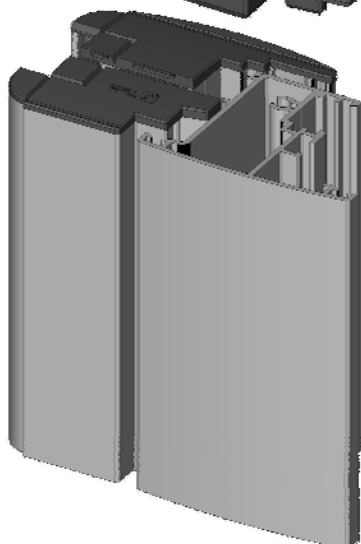
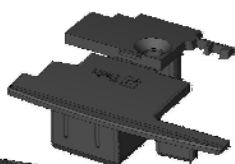
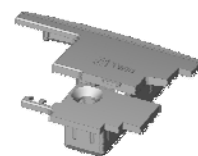



APPLICAZIONE TAPPI

CAPS INSTALLATION

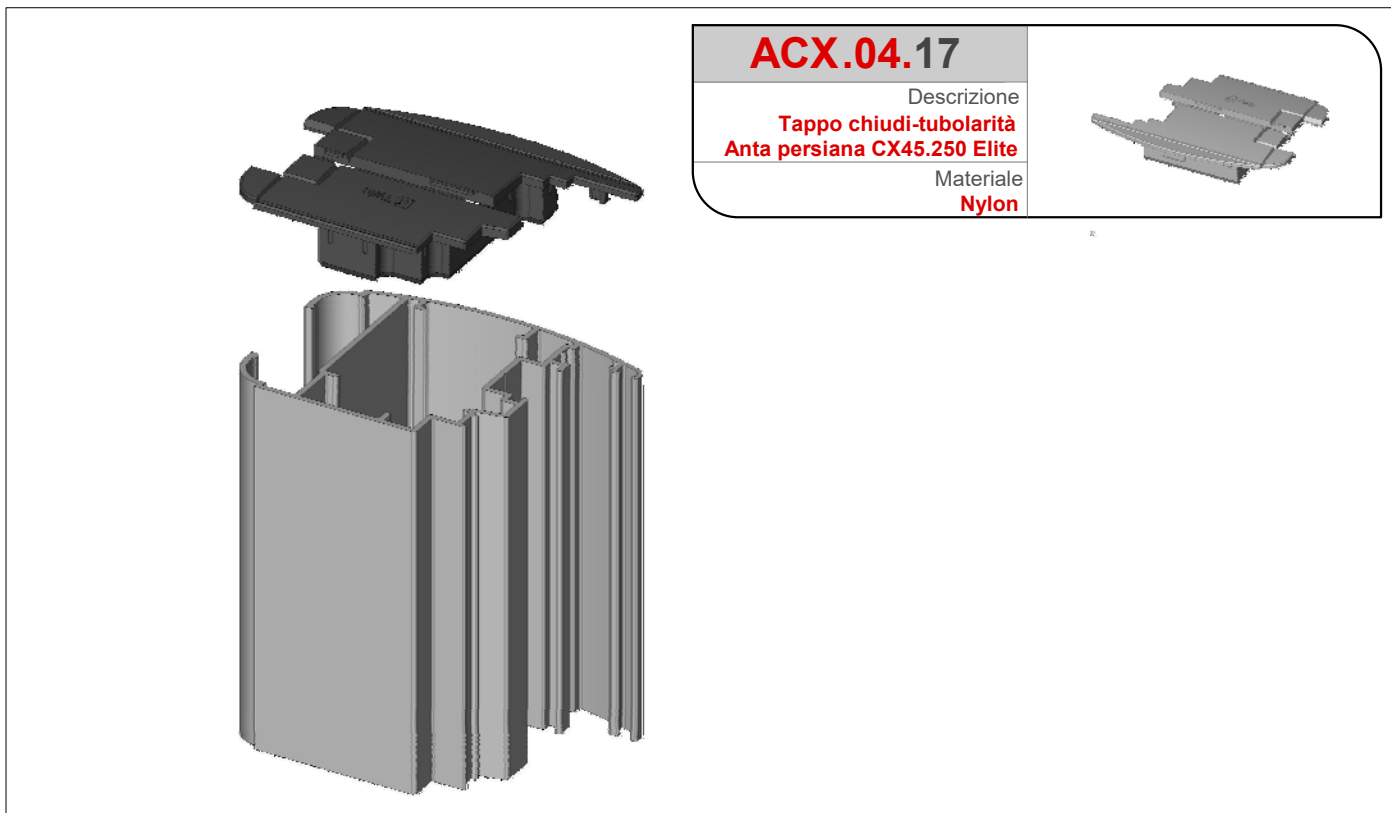

ACX.04.17

Descrizione
Tappo chiudi-tubolarità
Anta persiana CX45.250 Elite

Materiale
Nylon

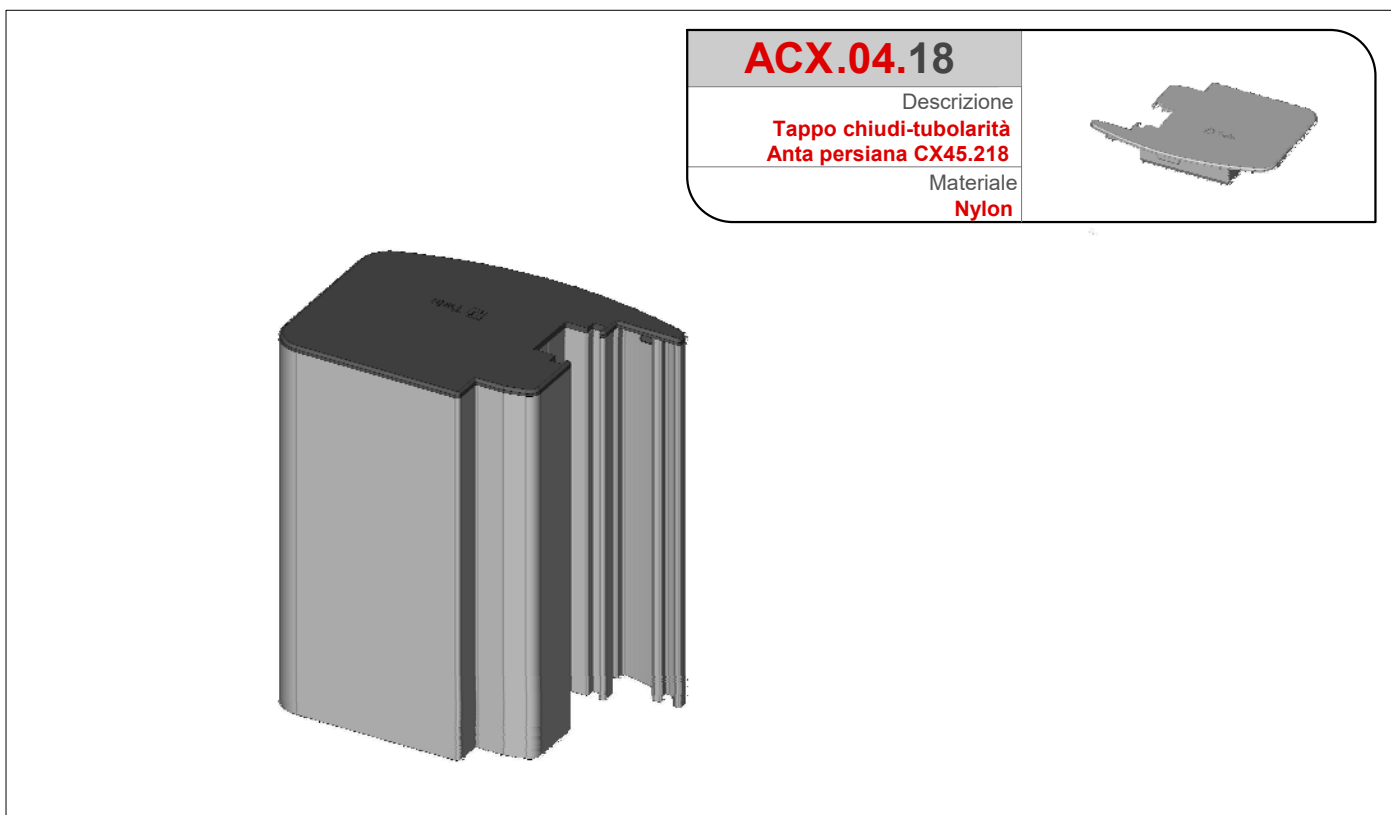
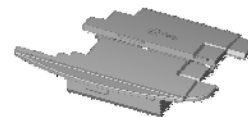

ACX.04.18

Descrizione
Tappo chiudi-tubolarità
Anta persiana CX45.218

Materiale
Nylon



Gli archivi digitali dei prodotti TWIN SYSTEMS
sono disponibili nei formati:

*The digital files of the TWIN SYSTEMS
products are available in the formats:*



AUTODESK[®]
AUTOCAD[®]



AUTODESK[®]
REVIT[®]

Il presente Catalogo assieme ai cataloghi di tutti i
prodotti TWIN SYSTEMS sono liberamente scaricabili:

*The digital files of the TWIN SYSTEMS products are available
in the formats:*



www.twinsystems.it/web/richiesta-dwg



www.twinsystems.it/professionisti/cataloghi/

PAM SYSTEM S.r.l.

S.S. 230 - Fornace Crocicchio - 13030 Formigiana (VC)
Tel. 0161 858811 - Fax 0161 858800
www.pamsystemsrl.com - info@pamsystemsrl.com

ALQ System S.p.A.

Direzione & Magazzino
Via Colano, 9/A 12/K 16162 Genova B olzaneto [GE] Tel.
10 7491941 - Fax 010 7450155
Magazzino
Via F.Lli Cervi 71 50013 Campi Bisenzio [FI]
Tel. 055 8825060 - Fax 055 8824916
www.alqsystem.it - info@alqsystem.it

PAESANI GROUP

Direzione & Magazzino
Via del Grano, 260 - 47822 Santarcangelo di Romagna [RN]
Tel. 0541 748511 - Fax 0541 741208
www.paesani.com - info@paesani.com

Magazzino Nord

Via Luigi Bonati, 21 - 29017 Fiorenzuola d'Arda (PC)
Tel. 0523 943138
www.paesani.com - info@paesani.com

DI.V.A. S.r.l.

Via Po, 25 - Z. I. Sambuceto
66020 San Giovanni Teatino (CH)
Tel. 085 4405210 - Fax 085 4405207
www.camel-diva.com - info@camel-diva.com

EUROALL S.r.l.

Strada Comunale della Mola Saracena, 23
Fiano Romano (RM) 00065
Tel. 0765 455228/61 - Fax 0765 455317
www.euroallslrl.it - info@euroallslrl.it

PROFILATI UMBRIA S.r.l.

Via Dei Tigli, 35 - 06083 Bastia Umbra (PG)
Tel. 075 8012385-075 8010328 - Fax 075 8012386
profilatiumbria@virgilio.it

TSL ALLUMINIO S.r.l.

Via delle Industrie, 12 00030 San Cesario (Roma)
Tel. 06 2251591 (Ric. Aut.) - Fax 06 2280693
www.tslalluminio.it - info@tslluminio.it

ALLCAR SERVICE S.r.l.

Via Acuto, 120 - 00131 Roma
Tel. 06 4130626 (Ric. Aut.) - Fax 064130367
allcarservice@mcclink.it

MIDA ALLUMINIO S.r.l.

Napoli
Via Piano del Principe, 36 80047 San Giuseppe Vesuviano (NA)
Tel. 081 5297373 - Fax 081 8284449
Salerno
Loc. Terzerie - Zona Industriale 80061 Ogliastro Cilento (SA)
Tel. 0974 833233 - Fax 0974 844724
www.midaalluminiogroup.it - info@gruppomida.it

CARUSO S.r.l.

Z.I. Contrada Le Macere - 86019 Vinchiaturo (CB)
Tel. 0874 340024 - Fax 0874 340025
carusosrl1@libero.it



CAIMAR S.n.c.

Direzione & Magazzino
Strada Prov.le Rimedio-Torregrande Km. 4
09072 Cabras (OR) - Tel. 0783 290118
Filiale
Fronte S.S. 131 Km. 17,450 Monastir [CA]
Tel. 070 9166020 - Fax 070 9166191
www.caimar.it - caimarmail@caimar.it

ALLUCOM S.r.l.

Andria
Via Vecchia Barletta 237 - Z. Ind. - 76123 Andria (BT)
Tel. 0883 592213 - Fax 0883 552386
Bari
Via Zippitelli 28/B - 70123 (BA)
Tel. 080 5058608 - Fax 080 5058607
www.allucom.com - info@allucom.com

ITALBACOLOR S.r.l.

C.da Valle S. Maria - 87024 Fuscaldo (CS)
Tel. 0982 618025 - Fax 0982 720235
www.italbacolor.it commerciale@italbacolor.it

COMAS S.r.l.

Via Porta Palermo, 84 - 91011 Alcamo (TP)
Tel. 0924 507050 - Fax 0924 507051
www.comasgroup.it - info@comasgroup.it

ALUK TIM

Aluk Tim D.o.o.
Žegoti 10, 51215 Kastav Croazia, UE
Tel: +385 (0) 51/691 461 - Fax: +385 (0) 51/691 473
https://www.aluk.hr - info@aluk.hr

Filiale di Zagabria

Franje Lučića, 34A Zagabria Croazia, UE
Tel: +385 (0) 1 6462 611 Mob: +385 (0) 99 2939656
Fax: +385 (0) 1 6462 610
zagreb@aluk.hr

Filiale Spalato

Street Sv. Nikole Tavelića, 13A 21204
Dugopolje Croazia, UE
Tel: +385 (0) 21225525
Mob: +385 (0) 99 2199228
Fax: +385 (0) 21660110
split@aluk.hr



Consorzio TWIN SYSTEMS
Via delle Macere, 20 | 00060 Formello [Roma]
Tel./Fax 06 23260298
info@twinsystems.it

